

McGraw-Hill

PORTABLE

Engineering

SECOND EDITION

ELECTRICAL ENGINEER'S PORTABLE HANDBOOK

- ▶ Completely updated for 2002 NEC
- ▶ New sections on electrical production systems
- ▶ New section on blown fiber technology

Robert B. Hickey

Copyright © 2004, 1999 by The McGraw-Hill Companies, Inc. All rights reserved. Manufactured in the United States of America. Except as permitted under the United States Copyright Act of 1976, no part of this publication may be reproduced or distributed in any form or by any means, or stored in a database or retrieval system, without the prior written permission of the publisher.

0-07-143349-X

The material in this eBook also appears in the print version of this title: 0-07-141820-2.

All trademarks are trademarks of their respective owners. Rather than put a trademark symbol after every occurrence of a trademarked name, we use names in an editorial fashion only, and to the benefit of the trademark owner, with no intention of infringement of the trademark. Where such designations appear in this book, they have been printed with initial caps.

McGraw-Hill eBooks are available at special quantity discounts to use as premiums and sales promotions, or for use in corporate training programs. For more information, please contact George Hoare, Special Sales, at george_hoare@mcgraw-hill.com or (212) 904-4069.

TERMS OF USE

This is a copyrighted work and The McGraw-Hill Companies, Inc. (“McGraw-Hill”) and its licensors reserve all rights in and to the work. Use of this work is subject to these terms. Except as permitted under the Copyright Act of 1976 and the right to store and retrieve one copy of the work, you may not decompile, disassemble, reverse engineer, reproduce, modify, create derivative works based upon, transmit, distribute, disseminate, sell, publish or sublicense the work or any part of it without McGraw-Hill’s prior consent. You may use the work for your own noncommercial and personal use; any other use of the work is strictly prohibited. Your right to use the work may be terminated if you fail to comply with these terms.

THE WORK IS PROVIDED “AS IS”. MCGRAW-HILL AND ITS LICENSORS MAKE NO GUARANTEES OR WARRANTIES AS TO THE ACCURACY, ADEQUACY OR COMPLETENESS OF OR RESULTS TO BE OBTAINED FROM USING THE WORK, INCLUDING ANY INFORMATION THAT CAN BE ACCESSED THROUGH THE WORK VIA HYPERLINK OR OTHERWISE, AND EXPRESSLY DISCLAIM ANY WARRANTY, EXPRESS OR IMPLIED, INCLUDING BUT NOT LIMITED TO IMPLIED WARRANTIES OF MERCHANTABILITY OR FITNESS FOR A PARTICULAR PURPOSE. McGraw-Hill and its licensors do not warrant or guarantee that the functions contained in the work will meet your requirements or that its operation will be uninterrupted or error free. Neither McGraw-Hill nor its licensors shall be liable to you or anyone else for any inaccuracy, error or omission, regardless of cause, in the work or for any damages resulting therefrom. McGraw-Hill has no responsibility for the content of any information accessed through the work. Under no circumstances shall McGraw-Hill and/or its licensors be liable for any indirect, incidental, special, punitive, consequential or similar damages that result from the use of or inability to use the work, even if any of them has been advised of the possibility of such damages. This limitation of liability shall apply to any claim or cause whatsoever whether such claim or cause arises in contract, tort or otherwise.

DOI: 10.1036/007143349X

Contents

Acknowledgments xi
Credits xiii
Preface to the Second Edition xv
Introduction: How to Use This Book xvii

Chapter 1. General Information **1**

1.0 Introduction 1
1.1 Checklists 1
1.2 Electrical Symbols and Mounting Heights 19
1.3 NEMA Device Configurations 33
1.4 IEEE Standard Electrical Power System Device
Function Numbers and Contact Designations 35
1.5 NEMA Standard Enclosures 58
1.6 Formulas and Terms 61
1.7 Typical Equipment Sizes and Weights 62
1.8 Seismic Requirements 62

**Chapter 2. National Electrical Code (NEC) Articles,
Tables, and Data** **69**

2.0 Working Space About Electric Equipment 69
2.1 Over 600 Volts, Nominal 80
2.2 Overcurrent Protection Standard Ampere Ratings 82
2.3 NEC Article 240.21: Location in Circuit
(Feeder Tap Rules) 84
2.4 NEC Article 310: Conductors for General Wiring 92

Acknowledgments

Many thanks to Mark W. Felgate, P.E.; Edward M. Grafe; and the entire electrical staff at van Zelm Heywood & Shadford, Inc. for their valuable input; and to Kristine M. Buccino for her assistance in getting permission to reprint copyrighted material.

A special thanks to Steve Chapman and his team at McGraw-Hill and to Stephanie Landis and her team at North Market Street Graphics, whose wonderful collaborative spirit and many professional talents made the publication of this second edition possible.

And finally, a very special thanks to my wife Pat for her continued encouragement and support.

Credits

Where indicated, reprinted with permission from NFPA 70 (2002), the *National Electrical Code*®, copyright © 2001, National Fire Protection Association, Quincy, MA 02269. This reprinted material is not the referenced subject which is represented only by the standard in its entirety.

Where indicated, reprinted with permission from the *National Electrical Code*® *Handbook*, copyright © 2004, National Fire Protection Association, Quincy, MA 02269. This reprinted material is not the referenced subject which is represented only by the standard in its entirety.

Where indicated, reprinted with permission from NFPA 72, *National Fire Alarm Code*®, copyright © 1996, National Fire Protection Association, Quincy, MA 02269. This reprinted material is not the referenced subject which is represented only by the standard in its entirety.

Tables 1.7–1.11 are reprinted with permission from *1996 Means Electrical Cost Data*, copyright R.S. Means Co., Inc., Kingston, MA, 781-585-7880, all rights reserved.

ACME Electric, BICSI Cablec Industrial Cable Co., Caterpillar, Cooper Bussman, Cutler-Hammer, Ferraz Shawmut, General Cable Corporation, Illuminating Engineering Society of North America, Institute of Electrical and Electronics Engineers, Kerite (Hubbell Power Systems), Okonite Company, OSRAM Sylvania, Pyrotex USA, Siemens Corporation, Square D (Schneider Electric).

Preface to the Second Edition

This second edition of the *Electrical Engineer's Portable Handbook* includes a number of significant updates and a few worthy additions and enhancements.

All *National Electrical Code*® articles, tables, data, references, and so on have been updated to the 2002 edition of the *Code* in Chap. 2 and elsewhere where they occur. Two major changes throughout the latest edition of the *NEC* are the system of nomenclature/paragraphing hierarchy and the metrification of units as primary in tables and data.

Chapter 3 contains updated motor circuit feeder schedules, a transformer primary and secondary feeder schedule, and a new table of three-phase, three-wire, and four-wire plus ground feeder schedules sized to the overcurrent protection rating. These should prove to be time-saving tools.

The grounding electrode system (main service grounding detail) diagram in Chap. 4 has been updated and an introductory overview of a dissipation array system (DAS) for lightning protection has been added. This is an emerging technology application of a long-known theory that is gaining popularity in some critical installations.

Telecommunications-structured cabling systems information in Chap. 8 has been completely replaced with the latest BICSI standards (including tables, diagrams, and illustrations). An introductory overview to blown optical fiber technology (BOFT) provides insight into this very interesting, cost-competitive, and extremely flexible optical fiber technology. It is particularly amenable to renovation/retrofit applications because of its flexibility and avoids initial capitalization for installing future capacity in new construction.

I hope you will find this second edition of the *Electrical Engineer's Portable Handbook* a truly useful addition to your design tools library.

Bob Hickey

Introduction: How to Use This Book

The concept of this book is that of a *personal tool*, which compacts 20 percent of the data that is needed 80 percent of the time by *electrical design professionals* in the preliminary design of buildings of all types and sizes.

This tool is meant to always be at one's fingertips (open on a drawing board, desk, or computer table; carried in a briefcase; or kept in one's pocket). It is never meant to sit on a bookshelf. It is meant to be used *everyday!*

Because design professionals are individualistic and their practices are so varied, the user is encouraged to *individualize this book* by adding notes or changing data as experience dictates.

Building codes and laws, new technologies, and materials are ever changing in this industry. Therefore, this book should be viewed as a *starter of simple data collection* that must be updated over time. New editions may be published in the future.

Because this book is so broad in scope, yet so compact, information can be presented in only one location, and not repeated. It is expected that the experienced practitioner is generally knowledgeable about the data and knows how to apply it properly. Information is often presented in the form of simple ratios, coefficients, application tips, or rules of thumb that leave the need for commonsense judgment.

This book is unique among handbooks. It provides myriad valuable time-saving data for the experienced practitioner, yet there are enough concept explanations and examples on critical topics to use it as a teaching tool for the fledgling electrical design professional. Also, the topics of Chapters 3 through 7, in particular, are arranged in a sequence that closely approximates the normal design process flow to facilitate speed for the experienced practitioner and learning for the beginner. The Index has been expanded to facilitate quickly locating needed information.

This book is *not a substitute* for professional expertise or other books of a more detailed and specialized nature, but will be a continuing everyday aid that takes the more useful "cream" off the top of other sources.

CHAPTER ONE

General Information

1.0 INTRODUCTION

This chapter provides information of a general nature that is frequently needed by the electrical design professional. Information that follows in subsequent chapters is more specific and closely follows the design process.

1.1 CHECKLISTS

The following checklists should prove useful in the execution of projects.

2 Electrical Engineer's Portable Handbook

FIGURE 1.1 Project to do checklist (electrical).

Page 1 of 3

Project Status Project: _____
 SD Proj. No: _____
 DD PM/PE: _____
 CD Date: _____

PreDesign

- Review Contract Scope
- Review Design Budget with P.M.
- Establish design criteria
- Establish design schedule
- Schedule review meetings & team
- Setup project notebook
- Code review
- Obtain as-built drawings
- Site survey
- Start project data sheet
- Contact Power Company
- Contact Telephone Company
- Review client's design requirements
- _____
- _____
- _____

Design

- Main electric service
- Power Distribution system
- Branch circuits
- Building lighting
- Site lighting
- Main telephone service
- _____
- _____

Other Systems

- Communications Consultant
- AV Consultant
- Food Service Consultant
- Elevator Consultant
- Theatre Consultant
- Division 16 coordinated with Div. 15/13
- _____

Load Analysis

- Schematic, sq.foot basis
- Mechanical loads finalized
- Process equipment loads finalized
- Final design loads scheduled
- _____

Fault Current Analysis

- Rough estimate pre-design
- Final analysis

Coordination Study

- Rough selection pre-design
- Final study

Special Systems

- Fire alarm & smoke detection system
- Telephone outlets
- TV outlets
- Elevator System
- Data outlets
- Intercom system
- Security system
- Standby generators & Automatic Transfer Switch
- Energy Management System
- Grounding systems
- Lightning Protection system
- _____
- _____

FIGURE 1.1 Project to do checklist (electrical). (*Continued*)

	Page 2 of 3
	Project Status Project: _____
	<input type="checkbox"/> SD Proj. No: _____
	<input type="checkbox"/> DD PM/PE: _____
	<input type="checkbox"/> CD Date: _____
<p>Specification</p> <ul style="list-style-type: none"> <input type="checkbox"/> Cover <input type="checkbox"/> Bidding forms <input type="checkbox"/> General Conditions & Division 1 <input type="checkbox"/> Non-electrical sections <input type="checkbox"/> Division 13 sections <input type="checkbox"/> Division 15 sections <input type="checkbox"/> Division 16 sections <p>Construction Estimates</p> <ul style="list-style-type: none"> <input type="checkbox"/> Schematic design <input type="checkbox"/> Design development <input type="checkbox"/> Construction documents <p>Drawings</p> <ul style="list-style-type: none"> <input type="checkbox"/> Title block & drawing size <input type="checkbox"/> Site plans <input type="checkbox"/> Demolition plans <input type="checkbox"/> Symbol list <input type="checkbox"/> Abbreviation list <input type="checkbox"/> General notes <input type="checkbox"/> Power plans <input type="checkbox"/> Lighting plans <input type="checkbox"/> Fixture schedule <input type="checkbox"/> One-line power diagram <input type="checkbox"/> Switchboard schedules <input type="checkbox"/> MCC schedules <input type="checkbox"/> Distribution panelboard schedules <input type="checkbox"/> Lighting panelboard schedules <input type="checkbox"/> Fire detection & alarm plans <input type="checkbox"/> Fire detection & alarm one-line diagram <input type="checkbox"/> Building grounding grid plan <input type="checkbox"/> Lightning protection plan 	<p>Electrical Details</p> <ul style="list-style-type: none"> <input type="checkbox"/> Front Elevation Switchboards <input type="checkbox"/> Front Elevation MCCs <input type="checkbox"/> _____ <input type="checkbox"/> _____ <p>Site Details</p> <ul style="list-style-type: none"> <input type="checkbox"/> Concrete Bases for Lighting Poles <input type="checkbox"/> Transformer Concrete Pads & Grounding <input type="checkbox"/> Equipment Concrete Pads & Grounding <input type="checkbox"/> Manholes, Ductbanks, Grounding <input type="checkbox"/> Trench, backfill & reseed <input type="checkbox"/> Pavement <input type="checkbox"/> _____ <p>Drawing Check</p> <ul style="list-style-type: none"> <input type="checkbox"/> Overlay electrical drawings <input type="checkbox"/> Complete drawing checklists <input type="checkbox"/> Complete site checklists <input type="checkbox"/> _____ <input type="checkbox"/> _____ <p>In House Review</p> <ul style="list-style-type: none"> <input type="checkbox"/> Conceptual review <input type="checkbox"/> Schematic Design <input type="checkbox"/> Design Development <input type="checkbox"/> Construction Documents <p>Client Submission</p> <ul style="list-style-type: none"> <input type="checkbox"/> Schematic Design <input type="checkbox"/> Design Development <input type="checkbox"/> Construction Documents

4 Electrical Engineer's Portable Handbook

FIGURE 1.1 Project to do checklist (electrical). (*Continued*)

	Page 3 of 3
Project Status	Project: _____
<input type="checkbox"/> SD	Proj. No: _____
<input type="checkbox"/> DD	PM/PE: _____
<input type="checkbox"/> CD	Date: _____

Design Closeout

- Complete project data sheet
- Project profile completed
- File the design calculations
- Complete the design notebook

Has Power Company Reviewed Designed Service? Yes No Not Required

Charges: \$ _____ Unknown

Has Power Company Been Sent Electrical Loads, Drawings and Specs?

Yes No Not Required

- Send client record documents
- _____
- _____

FIGURE 1.2 Drawing design checklist (electrical).

		Page 1 of 3
Project Status		Project: _____
<input type="checkbox"/> SD		Proj. No: _____
<input type="checkbox"/> DD		PM/PE: _____
<input type="checkbox"/> CD		Date: _____
Items Included		
<input type="checkbox"/> Power Plan		
<input type="checkbox"/> Lighting Plan		
<input type="checkbox"/> Site Plan		
<input type="checkbox"/> Special System Plans		
<input type="checkbox"/> Symbol List		
<input type="checkbox"/> Abbreviation List		
<input type="checkbox"/> One Line - Power Diagram		
<input type="checkbox"/> One Line - Special Systems		
<input type="checkbox"/> Switchboard Schedules		
<input type="checkbox"/> Panelboard Schedules		
<input type="checkbox"/> Fixture Schedules		
<input type="checkbox"/> Site Details		
<input type="checkbox"/> Electrical Details		
<input type="checkbox"/> Building Grounding Plan		
<input type="checkbox"/> Lightning Protection Plan		
<input type="checkbox"/> General Notes		
<input type="checkbox"/> _____		
<input type="checkbox"/> _____		
<input type="checkbox"/> _____		
General Items to Check		
<input type="checkbox"/> Title Blocks		
<input type="checkbox"/> Firm Logo		
<input type="checkbox"/> Job Number		
<input type="checkbox"/> Drawing Title		
<input type="checkbox"/> Drawing Numbers		
<input type="checkbox"/> Date		
<input type="checkbox"/> Plan Titles with Scale		
<input type="checkbox"/> Detail Titles with Scale		
<input type="checkbox"/> Detail Designation Symbols		
<input type="checkbox"/> Symbol List Agrees with Drawing		
<input type="checkbox"/> Abbreviation List Agrees with Drawings		
<input type="checkbox"/> Openings and Floor Plans for Installation and Removal of Electrical and Generator Equipment		
<input type="checkbox"/> Electrical equipment access and clearances		
<input type="checkbox"/> Elevator Size Accommodates All Equipment		
<input type="checkbox"/> Electrical Plans Overlaid on:		
<input type="checkbox"/> Architectural Plans		
<input type="checkbox"/> Reflected Ceiling Plans		
<input type="checkbox"/> Mechanical Plans		
One-Line Power Diagram		
<input type="checkbox"/> Primary Distribution		
<input type="checkbox"/> Voltage		
<input type="checkbox"/> Fault Current Available		
<input type="checkbox"/> Cables and Raceways		
<input type="checkbox"/> Manholes and Pullboxes		
<input type="checkbox"/> Terminations and Splices		
<input type="checkbox"/> Primary Switchgear		
<input type="checkbox"/> Enclosure		
<input type="checkbox"/> Indoor	<input type="checkbox"/> Weatherproof	<input type="checkbox"/> Walk-in
<input type="checkbox"/> Selector Switches		
<input type="checkbox"/> Non-fused	<input type="checkbox"/> Fuse Size	
<input type="checkbox"/> Protective Devices		
<input type="checkbox"/> Stationary	<input type="checkbox"/> Drawout	
<input type="checkbox"/> Manual	<input type="checkbox"/> Electrical	
<input type="checkbox"/> Active	<input type="checkbox"/> Space & Busing	
<input type="checkbox"/> Breaker	<input type="checkbox"/> Trip Setting	
<input type="checkbox"/> Relay	<input type="checkbox"/> Trip Setting	
<input type="checkbox"/> Circuit Numbering		
<input type="checkbox"/> Arresters		
<input type="checkbox"/> Interlocks		
<input type="checkbox"/> Fault Rating		

6 Electrical Engineer's Portable Handbook

FIGURE 1.2 Drawing design checklist (electrical). (Continued)

		Page 2 of 3
		Project Status
<input type="checkbox"/> SD	<input type="checkbox"/> Owner	Project: _____
<input type="checkbox"/> DD	<input type="checkbox"/> Power Co.	Proj. No: _____
<input type="checkbox"/> CD		PM/PE: _____
		Date: _____

<p><input type="checkbox"/> Primary Metering</p> <p style="padding-left: 20px;"><input type="checkbox"/> Owner <input type="checkbox"/> Power Co.</p> <p><input type="checkbox"/> Transformers</p> <p style="padding-left: 20px;"><input type="checkbox"/> Primary Voltage</p> <p style="padding-left: 20px;"><input type="checkbox"/> Primary Connection</p> <p style="padding-left: 40px;"><input type="checkbox"/> Delta <input type="checkbox"/> Wye <input type="checkbox"/> Double Bushing</p> <p style="padding-left: 20px;"><input type="checkbox"/> Secondary Voltage</p> <p style="padding-left: 20px;"><input type="checkbox"/> Secondary Connection</p> <p style="padding-left: 40px;"><input type="checkbox"/> Delta <input type="checkbox"/> Wye</p> <p style="padding-left: 20px;"><input type="checkbox"/> Grounding</p> <p style="padding-left: 20px;"><input type="checkbox"/> KVA & Percent Impedance (Min.)</p> <p style="padding-left: 20px;"><input type="checkbox"/> Type:</p> <p style="padding-left: 40px;">(Oil, Dry, Padmount, Open, WP, etc.)</p> <p style="padding-left: 20px;"><input type="checkbox"/> Secondary Compartment C/Bs</p> <p style="padding-left: 20px;"><input type="checkbox"/> Surge Arresters</p> <p style="padding-left: 20px;"><input type="checkbox"/> Power Company Supplied</p> <p><input type="checkbox"/> Secondary Distribution</p> <p style="padding-left: 20px;"><input type="checkbox"/> Voltage</p> <p style="padding-left: 20px;"><input type="checkbox"/> Fault Current Available</p> <p style="padding-left: 20px;"><input type="checkbox"/> Cables and Raceways</p> <p style="padding-left: 20px;"><input type="checkbox"/> Manholes and Pullboxes</p> <p style="padding-left: 20px;"><input type="checkbox"/> Termination and Splices</p> <p>Secondary Switchboard</p> <p style="padding-left: 20px;"><input type="checkbox"/> Switchboard (NEMA PB-2 and UL 891)</p> <p style="padding-left: 20px;"><input type="checkbox"/> Switchgear (ANSI C37 and UL 1558)</p> <p style="padding-left: 20px;"><input type="checkbox"/> Rating <input type="checkbox"/> Current <input type="checkbox"/> Voltage</p> <p style="padding-left: 20px;"><input type="checkbox"/> Phase <input type="checkbox"/> Wire</p> <p style="padding-left: 20px;"><input type="checkbox"/> Fault Rating</p> <p style="padding-left: 20px;"><input type="checkbox"/> Service Entrance?</p> <p><input type="checkbox"/> Enclosure</p> <p style="padding-left: 20px;"><input type="checkbox"/> Free-standing <input type="checkbox"/> Non-freestanding</p> <p><input type="checkbox"/> Accessible</p> <p style="padding-left: 20px;"><input type="checkbox"/> Front <input type="checkbox"/> Rear <input type="checkbox"/> Side</p>	<p><input type="checkbox"/> Main Protective Device</p> <p style="padding-left: 20px;"><input type="checkbox"/> Fuse/Sw <input type="checkbox"/> Size & Class of Fuse</p> <p style="padding-left: 20px;"><input type="checkbox"/> Power Breaker <input type="checkbox"/> Insulated Case</p> <p style="padding-left: 40px;"><input type="checkbox"/> Molded Case</p> <p style="padding-left: 40px;"><input type="checkbox"/> Indv. Mount <input type="checkbox"/> Group Mount</p> <p style="padding-left: 20px;"><input type="checkbox"/> Stationary <input type="checkbox"/> Drawout</p> <p style="padding-left: 20px;"><input type="checkbox"/> Manual <input type="checkbox"/> Electrical</p> <p style="padding-left: 20px;"><input type="checkbox"/> Thermal/Magnetic <input type="checkbox"/> Solid State</p> <p style="padding-left: 20px;"><input type="checkbox"/> Number of Poles & Trip/Frame Amps</p> <p style="padding-left: 20px;"><input type="checkbox"/> 100% Duty <input type="checkbox"/> 80% Duty</p> <p style="padding-left: 20px;"><input type="checkbox"/> Shunt Trip</p> <p style="padding-left: 20px;"><input type="checkbox"/> Interlocks or Ties</p> <p><input type="checkbox"/> Ground Fault Protection</p> <p style="padding-left: 20px;"><input type="checkbox"/> Selective <input type="checkbox"/> Time Delay</p> <p><input type="checkbox"/> Service Ground</p> <p style="padding-left: 20px;"><input type="checkbox"/> Water Service</p> <p style="padding-left: 20px;"><input type="checkbox"/> Building Steel</p> <p style="padding-left: 20px;"><input type="checkbox"/> Ground Rod</p> <p style="padding-left: 20px;"><input type="checkbox"/> Ground Grid - Substation</p> <p style="padding-left: 20px;"><input type="checkbox"/> Ground Grid - Building</p> <p><input type="checkbox"/> Revenue Metering</p> <p style="padding-left: 20px;"><input type="checkbox"/> Active <input type="checkbox"/> Reactive</p> <p style="padding-left: 20px;"><input type="checkbox"/> CT's <input type="checkbox"/> PT's</p> <p><input type="checkbox"/> Owner Metering</p> <p style="padding-left: 20px;"><input type="checkbox"/> Volt <input type="checkbox"/> Amp <input type="checkbox"/> Watt <input type="checkbox"/> VA</p> <p style="padding-left: 20px;"><input type="checkbox"/> Watt Hr <input type="checkbox"/> VARS</p> <p style="padding-left: 20px;"><input type="checkbox"/> AMSS <input type="checkbox"/> VMSS</p> <p style="padding-left: 20px;"><input type="checkbox"/> Electronic</p> <p><input type="checkbox"/> Busing</p> <p style="padding-left: 20px;"><input type="checkbox"/> Full Neutral</p> <p style="padding-left: 20px;"><input type="checkbox"/> Ground Bus</p> <p style="padding-left: 20px;"><input type="checkbox"/> Equipment Ground</p> <p style="padding-left: 20px;"><input type="checkbox"/> Grounding Electrode Conductor</p> <p style="padding-left: 20px;"><input type="checkbox"/> Connection</p>
--	---

FIGURE 1.2 Drawing design checklist (electrical). (Continued)

		Page 3 of 3
Project Status <input type="checkbox"/> SD <input type="checkbox"/> DD <input type="checkbox"/> CD		Project: _____ Proj. No: _____ PM/PE: _____ Date: _____
<input type="checkbox"/> Main Feeder Cable and Raceways <input type="checkbox"/> Transfer Switches <input type="checkbox"/> Type <input type="checkbox"/> Automatic <input type="checkbox"/> Manual <input type="checkbox"/> Current Rating and # Poles <input type="checkbox"/> Control Connection <input type="checkbox"/> Load Feeder Cable and Raceway <input type="checkbox"/> 3 Pole or 4 Pole <input type="checkbox"/> Neutral and Ground Connection <input type="checkbox"/> Standby Generator <input type="checkbox"/> Emergency Generator <input type="checkbox"/> Line Circuit Breaker <input type="checkbox"/> Main Lug <input type="checkbox"/> Thermal <input type="checkbox"/> Magnetic <input type="checkbox"/> Solid State <input type="checkbox"/> Number of Poles & Trip/Frame Amps <input type="checkbox"/> GFP <input type="checkbox"/> Sel. <input type="checkbox"/> Timedelay <input type="checkbox"/> Load Feeder Cable and Raceway <input type="checkbox"/> Neutral and Ground Connections <input type="checkbox"/> Power Distribution (Panelboard and MCC) <input type="checkbox"/> Bus Data <input type="checkbox"/> Current <input type="checkbox"/> Voltage <input type="checkbox"/> Phase <input type="checkbox"/> Wire <input type="checkbox"/> Fault Current <input type="checkbox"/> Full Neutral <input type="checkbox"/> Equipment Ground <input type="checkbox"/> Insulated <input type="checkbox"/> Enclosure <input type="checkbox"/> Weatherproof <input type="checkbox"/> Walk-in <input type="checkbox"/> Mounting <input type="checkbox"/> Individual <input type="checkbox"/> Group (Panel Sched.) <input type="checkbox"/> Stationary <input type="checkbox"/> Drawout	<input type="checkbox"/> Operation <input type="checkbox"/> Manual <input type="checkbox"/> Automatic <input type="checkbox"/> Protective Devices <input type="checkbox"/> Circuit Numbering <input type="checkbox"/> Fuse/Switch <input type="checkbox"/> Fuse Size/Class <input type="checkbox"/> Combination Starter <input type="checkbox"/> Fuse/Switch & Fuses <input type="checkbox"/> Circuit Breaker <input type="checkbox"/> Mag. Only <input type="checkbox"/> Starter Size & Type <input type="checkbox"/> Overload Relays <input type="checkbox"/> Circuit Breaker <input type="checkbox"/> Power <input type="checkbox"/> Insulated Case <input type="checkbox"/> Molded Case <input type="checkbox"/> 100% Duty <input type="checkbox"/> Mixed Duty <input type="checkbox"/> Thermal/Magnetic <input type="checkbox"/> Magnetic <input type="checkbox"/> Solid State <input type="checkbox"/> Number of Poles <input type="checkbox"/> Trip/Frame Amps <input type="checkbox"/> Ground Fault Protection <input type="checkbox"/> Selective <input type="checkbox"/> Time Delay <input type="checkbox"/> Interlocks <input type="checkbox"/> Key <input type="checkbox"/> Electric	

8 Electrical Engineer's Portable Handbook

FIGURE 1.3 Site design checklist (electrical).

		Page 1 of 2	
		Project Status	Project: _____
		<input type="checkbox"/> SD	Proj. No: _____
		<input type="checkbox"/> DD	PM/PE: _____
		<input type="checkbox"/> CD	Date: _____
Site Drawings - Plans		Aerial Distribution	
<input type="checkbox"/> Title		<input type="checkbox"/> Electric Primary	
<input type="checkbox"/> Scale		<input type="checkbox"/> Electric Secondary	
<input type="checkbox"/> Benchmark		<input type="checkbox"/> Telephone	
<input type="checkbox"/> Topo Lines		<input type="checkbox"/> Site Lighting	
Top Elevation on:		<input type="checkbox"/> TV	
<input type="checkbox"/> Transformer Pads		Underground Distribution	
<input type="checkbox"/> Switchgear Pads		<input type="checkbox"/> Electric Primary	
<input type="checkbox"/> Pole Bases for Site Lighting		<input type="checkbox"/> Electric Secondary	
<input type="checkbox"/> Standby Generator Pads		<input type="checkbox"/> Telephone	
<input type="checkbox"/> Manholes		<input type="checkbox"/> TV	
<input type="checkbox"/> Pullboxes		<input type="checkbox"/> Site Lighting	
 		<input type="checkbox"/> Conduit Sleeves Under Pavement	
<input type="checkbox"/> Existing Utility Poles and Numbers		Fuel Oil Systems	
<input type="checkbox"/> New Utility Poles and Guys (by whom)		<input type="checkbox"/> Fuel Oil Tank	
<input type="checkbox"/> Pole Transformers (by whom)		<input type="checkbox"/> Supply and Return Lines	
<input type="checkbox"/> Pad Mount Transformers (by whom)		<input type="checkbox"/> Fill Cap and Fill Lines	
<input type="checkbox"/> Revenue Meters		<input type="checkbox"/> Vent Cap and Vent Lines	
<input type="checkbox"/> Site Lighting Poles		<input type="checkbox"/> Tank Level Gauge Line	
<input type="checkbox"/> Generator (Outdoor)		<input type="checkbox"/> Soil Condition - Anodes, FG	
<input type="checkbox"/> Switchgear (Outdoor)		<input type="checkbox"/> Direction of Line Pitch	
<input type="checkbox"/> Manholes			
<input type="checkbox"/> Pullboxes			
Check Site Planting, Grades, Fences, Equipment for Truck Access to:		Check Truck Wheel Loading Cover:	
<input type="checkbox"/> Padmount Transformers		<input type="checkbox"/> Fuel Oil Tanks	
<input type="checkbox"/> Utility Poles		<input type="checkbox"/> Underground Lines	
<input type="checkbox"/> Site Lighting Poles		<input type="checkbox"/> Manholes	
		<input type="checkbox"/> Pullboxes	

FIGURE 1.3 Site design checklist (electrical). *(Continued)*

	Page 2 of 2
<p>Project Status</p> <p><input type="checkbox"/> SD</p> <p><input type="checkbox"/> DD</p> <p><input type="checkbox"/> CD</p>	<p>Project: _____</p> <p>Proj. No: _____</p> <p>PM/PE: _____</p> <p>Date: _____</p>
Site Drawings - Details	
<p><input type="checkbox"/> Titles</p> <p><input type="checkbox"/> Scale</p> <p><input type="checkbox"/> Utility Pole Riser</p> <p><input type="checkbox"/> Revenue Meter Riser</p>	
<p>Trench Cross Sections</p> <p style="padding-left: 20px;"><input type="checkbox"/> Electric, Telephone and TV Lines</p> <p style="padding-left: 20px;"><input type="checkbox"/> Duct Banks, Concrete and Grounding</p>	
<p><input type="checkbox"/> Padmount Transformer, Concrete Pad & Grounding</p> <p><input type="checkbox"/> Exterior Switchgear, Concrete Pad & Grounding</p> <p><input type="checkbox"/> Generator, Concrete Pad & Grounding</p> <p><input type="checkbox"/> Manholes, Concrete, Cable Racks & Grounding</p> <p><input type="checkbox"/> Pullboxes, Concrete, & Grounding</p> <p><input type="checkbox"/> Pole Bases for Site Lighting and Signs</p>	
<p>Fuel Oil Systems</p> <p style="padding-left: 20px;"><input type="checkbox"/> Fuel Oil Tank, Concrete Pad</p> <p style="padding-left: 20px;"><input type="checkbox"/> Trench Cross Sections for Supply & Return Lines</p> <p style="padding-left: 20px;"><input type="checkbox"/> Fill, Vent and Level Gage Lines</p> <p style="padding-left: 20px;"><input type="checkbox"/> Fuel Fill Cap</p> <p style="padding-left: 20px;"><input type="checkbox"/> Fuel Vent Cap</p>	

10 Electrical Engineer's Portable Handbook

FIGURE 1.4 Existing condition service & distribution checklist.

Page 1 of 3

Project: _____
Proj. No.: _____
PM/PE: _____
Date: _____

Power Company Service

Power Company: _____
Rep Name: _____
Telephone: _____

Type of Service:
 Primary Secondary Unknown

 Underground Overhead
 Combination Unknown

Transformation
 Pad Pole N/A Unknown
KVA: _____ Unknown
% Impedance: _____ Unknown
Primary Voltage _____ Unknown
Secondary Voltage: _____ Unknown

Short Circuit Fault Current Available
 Power Company Sym
 Primary MVA
 Secondary: _____ A
 Unknown

Power Company Pole #: _____ Unknown

New Poles: Street Line Private
 N/A Unknown

Primary Service
Raceway Size: _____ Unknown
Type: RSC PVC PVC/Conc.
 DB: _____ Unknown
Cable: _____ Unknown
Ground Conductor: _____ Unknown

Secondary Service
Raceway Size: _____ Unknown
Type: RSC PVC PVC/Conc.
 DB: _____ Unknown
Cable: _____ Unknown

Type of Power Available at Site Line
Primary 1PH 3PH Unknown
Sec 1PH 3 PH Unknown

Has Power Company Been Contacted for Existing Loads and Requirements for new services?
 Yes No Not Req.

Comments:

Main Electric Service

Main Entrance Capacity:
Size _____ A Unknown
Total Load
_____ KW _____ KVA
Power Factor _____ Unknown
Largest Connected Motor N/A
_____ HP Unknown
Starter Size & Type _____ Unknown

FIGURE 1.4 Existing condition service & distribution checklist. (Continued)

Page 2 of 3
 Project: _____
 Proj. No: _____
 PM/PE: _____
 Date: _____

Main Protective Device:

Fuse/Switch MCCB ICCB

Power breaker _____ Unknown

Duty: 80% 100% Unknown

Type of Trip: Thermal Magnetic

Solid State

GFP Yes No Unknown

Selective Time Delay

Current Limiting

Yes No Unknown

CT's Required: Yes No Unknown

PT's Required: Yes No Unknown

Who Supplies CT's and PT's:

_____ Unknown

Revenue Meters

Active Reactive Unknown

Inside Outside Unknown

Type of Construction

Panelboard Switchboard

Unitized MCC _____

Grounding Electrode Conductor

Size _____

Ground Rod Water Service

Rating of Gear

_____ AIC Sym. Unknown

Comments:

Power Distribution System N/A

Main Distribution Bus _____ A Unknown

Rating _____ AIC Sym Unknown

Distribution Devices

Fuse/Switch MCCB ICCB

Power breaker _____ Unknown

Duty: 80% 100% Unknown

Type of Trip: Thermal Magnetic

Solid State

GFP Yes No Unknown

Selective Time Delay

Current Limit Yes No Unknown

Raceways Aluminum RSC ISC

EMT PVC Unknown

Conductor Type _____ Unknown

Voltage Systems #1 _____ Unknown

#2 _____

Raceway Location Exposed Unknown

Concealed in: Walls Ceilings

Floors Unknown

Busway Aluminum Copper WP

N/A Unknown

Feeder Plug-in Standard

LVD CL

Plug In Unit: Fuse/Switch N/A

Circuit Breaker Unknown

Dry Type Transformer

1 PH 3 PH N/A Unknown

Minimum Impedance _____ %

12 Electrical Engineer's Portable Handbook

FIGURE 1.4 Existing condition service & distribution checklist. (*Continued*)

	Page 3 of 3
	Project: _____
	Proj. No: _____
	PM/PE: _____
	Date: _____
Sub Panels:	
<input type="checkbox"/> 1 PH <input type="checkbox"/> 3 PH <input type="checkbox"/> N/A <input type="checkbox"/> Unknown	
Rating: _____ AIC sym <input type="checkbox"/> Unknown	
Branch Breakers: <input type="checkbox"/> Standard	
<input type="checkbox"/> Switching Duty <input type="checkbox"/> Unknown	
Comments:	

FIGURE 1.5 Design coordination checklist (electrical).

		Page 1 of 3
Project Status <input type="checkbox"/> SD <input type="checkbox"/> DD <input type="checkbox"/> CD		Project: _____ Proj. No: _____ PM/PE: _____ Date: _____
Electrical Drawings - Plans		<u>Coord./% Complete</u>
Check that electrical floor plans match architectural and mechanical plans.	Y N N/A	
Check that the location of floor mounted equipment is consistent between disciplines.	Y N N/A	
Check that the location of light fixtures matches architectural reflected ceiling plan.	Y N N/A	
Check that elevator power, telephone and recall systems are shown and coordinated with architectural and fire protection	Y N N/A	
Check that light fixtures do not conflict with the structure or the mechanical HVAC system.	Y N N/A	
Check electrical connections to major equipment. Check that horsepower rating, phase, voltage, starter and drive types are consistent with other trade schedules.	Y N N/A	
Check that locations of panelboards are consistent with architectural floor plans, mechanical floor plans, plumbing & fire protection floor plans.	Y N N/A	
Check that the panelboards are indicated on the electrical riser diagram.	Y N N/A	
Check that HVAC control power needs are addressed.		
Check that notes are referenced.	Y N N/A	
Check that locations of electrical conduit runs, floor trenches, and openings are coordinated with structural plans.	Y N N/A	
Check that electrical panels are not recessed in fire rated walls.	Y N N/A	
Check that locations of exterior electrical equipment are coordinated with site paving, grading and landscaping.	Y N N/A	
Check that structural supports are provided for rooftop electrical equipment.	Y N N/A	
Food Service Drawings		
Check that the equipment layout matches other trade floor plans.	Y N N/A	
Check that there are no conflicts with columns.	Y N N/A	
Check that equipment is connected to utility systems.	Y N N/A	

14 Electrical Engineer's Portable Handbook

FIGURE 1.5 Design coordination checklist (electrical). (Continued)

		Page 2 of 3		
		Project Status	Project: _____	
		<input type="checkbox"/> SD	Proj. No: _____	
		<input type="checkbox"/> DD	PM/PE: _____	
		<input type="checkbox"/> CD	Date: _____	
		<u>Coord./% Complete</u>		
Check that equipment as scheduled on the drawings matches the kitchen floor plans and specifications.	Y	N	N/A	
Check that floor depressions and floor troughs are coordinated.	Y	N	N/A	
Check that kitchen equipment is schedule and coordinated with floor plans.	Y	N	N/A	
Communication Drawings				
Check that equipment layout matches Architect and Consultant Plans.	Y	N	N/A	
Check for conflicts between equipment/device spacing, clearances and access.	Y	N	N/A	
Check for Architect's or Consultant's typical elevations and details showing special device location and mounting heights.	Y	N	N/A	
Check empty raceway systems for coordination with Consultant's equipment and wiring.	Y	N	N/A	
Check for coordination between Specialty Contractor responsibility and Electrical Contractor responsibility.	Y	N	N/A	
A/V Drawings				
Check that equipment layout matches Architect and Consultant Plans.	Y	N	N/A	
Check for conflicts between equipment/device spacing, clearances and access.	Y	N	N/A	
Check for Architect's or Consultant's typical elevations and details showing special device location and mounting heights.	Y	N	N/A	
Check empty raceway systems for coordination with Consultant's equipment and wiring.	Y	N	N/A	
Check for coordination between Specialty Contractor responsibility and Electrical Contractor responsibility.	Y	N	N/A	
Theatre Drawings				
Check that equipment layout matches Architect and Consultant Plans.	Y	N	N/A	
Check for conflicts between equipment/device spacing, clearances and access.	Y	N	N/A	

FIGURE 1.5 Design coordination checklist (electrical). (Continued)

		Page 3 of 3		
Project Status		Project:	_____	
<input type="checkbox"/> SD		Proj. No:	_____	
<input type="checkbox"/> DD		PM/PE:	_____	
<input type="checkbox"/> CD		Date:	_____	
		Coord./% Complete		
Check for Architect's or Consultant's typical elevations and details showing special device location and mounting heights.	Y	N	N/A	
Check empty raceway systems for coordination with Consultant's equipment and wiring.	Y	N	N/A	
Check for coordination between Specialty Contractor responsibility and Electrical Contractor responsibility.	Y	N	N/A	
Specifications				
Check that bid items explicitly state what is intended.	Y	N	N/A	
Check specifications for phasing of construction.	Y	N	N/A	
Check that architectural finish schedule agrees with specification index.	Y	N	N/A	
Check that major equipment items are coordinated with contract drawings.	Y	N	N/A	
Check that items specified "as indicated" and "where indicated" in the specifications are in fact indicated on the contract drawings.	Y	N	N/A	
Check that the table of contents matches the sections contained in the body of the specifications.	Y	N	N/A	

16 Electrical Engineer's Portable Handbook

FIGURE 1.6 Fire alarm system checklist.

				Page 1 of 3
				Project: _____
				Proj. No: _____
				PM/PE: _____
				Date: _____
Part One - Central Reporting Requirements				
Emergency Forces Notification	Y	N	N/A	
Auxiliary Alarm System: (Alarms transmitted directly to municipal communication center)	Y	N	N/A	
Central Station: (Alarms transmitted to a station location with 24 hour supervision?)	Y	N	N/A	
Central Station System: (Alarms automatically transmitted to, recorded in, maintained and supervised from an approved central supervising station)	Y	N	N/A	
Proprietary Protective System: (Alarms automatically transmitted to a central supervising station on the Agency property with trained personnel and 24 hour supervision)	Y	N	N/A	
Remote Station System: (Alarms transmitted to a location remote from the building where circuits are supervised and appropriate action is taken)	Y	N	N/A	
Part Two - Fire Alarm System				
Is there a building presently equipped with a Fire Alarm System? If yes: indicate Make/Model _____ Type: _____ Date installed: _____	Y	N	N/A	
Will this project extend/expand the existing system?	Y	N	N/A	
Does the existing system conform to current Codes?			NFPA	Y N N/A
			BOCA	Y N N/A
			ADA	Y N N/A
			NEC	Y N N/A
Is the existing system a conventional or an addressable system?	Y	N	N/A	
Is all existing equipment of the same make and manufacturer?	Y	N	N/A	
Is the "Fire Alarm Control Panel", located at the Primary Building Entrance or Main Lobby?	Y	N	N/A	
Is the "Fire Alarm Control Panel" and "Annunciator" currently located at a location approved by the State or local Fire Marshal?	Y	N	N/A	
Are system components readily available?	Y	N	N/A	

FIGURE 1.6 Fire alarm system checklist. (*Continued*)

	Page 2 of 3
	Project: _____
	Proj. No: _____
	PM/PE: _____
	Date: _____
Have you inspected the existing Fire Alarm System?	Y N N/A
Have you received Agency information on the operational status of the existing system?	Y N N/A
Is the building equipped with adequate peripheral devices (i.e., pull stations, back up power, heat and smoke detectors, horn/speaker and strobe lights?)	Y N N/A
Is the existing panel and annunciator capable of accommodating the system expansion due to the new renovations?	Y N N/A
Have you requested copies of the latest State Fire Marshal citations?	Y N N/A
Are there smoke detectors at the elevator lobbies for the elevator recall system where required by Code?	Y N N/A
Are there smoke detectors in locations required by the Elevator Code (ASME/ANSI A 17.1)?	Y N N/A
Are there adequate quantities of horn/speaker and strobe lights in the corridors?	Y N N/A
Is the building equipped with a Fire-Fighter's phone system at each stairwell and elevator lobby?	Y N N/A
Have you verified that smoke detectors in residential rooms have been located away from cooking stoves and shower stalls?	Y N N/A
Have you specified "single-station", and not "system" detectors in the sleeping residential areas?	Y N N/A
Have air handling units been equipped with duct-smoke detectors, as required by NFPA Codes?	Y N N/A
Are air handling units annunciated at the building annunciator for easy identification of alarm location?	Y N N/A
Is the existing system connected to a Fire Department or other answering service?	Y N N/A
If a new building, is the system specified compatible with the existing campus system?	Y N N/A
Is the system specified as a "Proprietary" system?	Y N N/A
Does the Specification cite three manufacturers of equal quality meeting DPW and Agency requirements?	Y N N/A

18 Electrical Engineer's Portable Handbook

FIGURE 1.6 Fire alarm system checklist. (Continued)

	Page 3 of 3
	Project: _____
	Proj. No: _____
	PM/PE: _____
	Date: _____
If building is a high-rise, does the fire alarm system conform to BOCA high-rise requirements?	Y N N/A
Are stairwells required to have a pressurized smoke ventilation system?	Y N N/A
Is the building sprinkler system connected to the Fire Alarm Control Panel and "Annunciator" system?	Y N N/A
Is the building equipped with a fire pump?	Y N N/A
Is the fire alarm system backed up by a battery and standby generator system?	Y N N/A
Is the Fire Pump Electrical Service connected ahead of the Main Service Entrance switch?	Y N N/A
Part Three - Elevator Related Questions	
Does BOCA or NFPA Code require this building to be fully sprinklered?	Y N N/A
When the building is fully sprinklered; are there sprinkler heads in the Elevator Machine Room, and at the top and bottom of each elevator shaft?	Y N N/A
Is the power to the elevator automatically shut off by a heat detector and shunt trip breaker; prior to sprinkler discharge?	Y N N/A
Are elevator recall smoke detectors isolated from the building's Fire Alarm System?	Y N N/A
Do the elevator detectors report to the main Fire Alarm Panel?	Y N N/A
Is the proposed elevator room steel fire proofing provided by a material acceptable to the State Elevator Inspector?	Y N N/A
Is there a sump pit and duplex outlet in each elevator pit?	Y N N/A
Is the elevator pit equipped with a guarded lighting fixture, light switch and duplex outlet?	Y N N/A
Does the electrical wiring, equipment, pipes, ducts, etc. in hoistways and machine rooms conform to Section 102 of the Elevator Code (ASME/ANSI A17.1 Code)?	Y N N/A
Is there any water piping in the elevator shaft or machine room which does not serve the shaft or machine room?	Y N N/A
If there is a standby generator in the building, is any elevator connected to the standby power?	Y N N/A
Does the design comply with ADA Section 4.10 requirements for elevators?	Y N N/A

1.2 ELECTRICAL SYMBOLS AND MOUNTING HEIGHTS

Electrical Symbols

Electrical symbols can vary widely, but the following closely adhere to industry standards. Industry standard symbols are often modified to meet client and/or project specific requirements.

FIGURE 1.7 Electrical symbols.













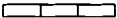

LIGHTING	
SYMBOL	DESCRIPTION
	CEILING MOUNTED LIGHT FIXTURE; SUBLETTER INDICATES FIXTURE TYPE
	WALL MOUNTED LIGHT FIXTURE; SUBLETTER INDICATES FIXTURE TYPE
	2'x4' CEILING MOUNTED FLUORESCENT LIGHT FIXTURE; SUBLETTER INDICATES FIXTURE TYPE
	DUAL BALLAST 2'x4' CEILING MOUNTED FLUORESCENT LIGHT FIXTURE; SUBLETTER INDICATES FIXTURE TYPE
	1'x4' CEILING MOUNTED FLUORESCENT LIGHT FIXTURE; SUBLETTER INDICATES FIXTURE TYPE
	2'x2' CEILING MOUNTED FLUORESCENT LIGHT FIXTURE; SUBLETTER INDICATES FIXTURE TYPE
	TYPICAL CEILING MOUNTED FLUORESCENT FIXTURE- NORMAL/EMERGENCY
	CONTINUOUS FLUORESCENT LIGHT FIXTURE
	WALL WASHER LIGHT FIXTURE
	LIGHT ON EMERGENCY CIRCUIT
	FLUORESCENT STRIP LIGHT FIXTURE; SUBLETTER INDICATES FIXTURE TYPE
	POWER LIGHT TRACK WITH NUMBER OF FIXTURES AS INDICATED ON PLANS; SUBLETTER INDICATES FIXTURE TYPE
	SINGLE OR DUAL HEAD, WALL MOUNTED, REMOTE EMERGENCY LIGHT
	DOUBLE FACED CEILING OR WALL-MOUNTED, EXIT SIGN WITH EMERGENCY POWER BACK UP AND DIRECTIONAL ARROWS AS INDICATED ON PLANS
	SINGLE FACED CEILING OR WALL-MOUNTED EXIT SIGN WITH EMERGENCY POWER BACK UP AND DIRECTIONAL ARROWS AS INDICATED ON PLANS
	CEILING OR WALL-MOUNTED, SELF-CONTAINED EMERGENCY LIGHT UNIT; FIXTURE SHALL MONITOR LIGHTING CIRCUIT IN AREA.
	EMERGENCY LIGHTING BATTERY UNIT

FIGURE 1.7 Electrical symbols. (Continued)

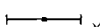
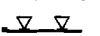
SWITCHES	
S	SINGLE-POLE SWITCH
S ₂	DOUBLE-POLE SWITCH
S ₃	3-WAY SWITCH
S ₄	4-WAY SWITCH
S _P	SINGLE-POLE SWITCH AND PILOT LIGHT
S _{be}	BOILER EMERGENCY SWITCH
S _{DM}	SINGLE-POLE DIMMER SWITCH
S _{DM3}	3-WAY DIMMER SWITCH
S _T	SINGLE-POLE SWITCH WITH THERMAL OVERLOAD PROTECTION
S _K	SINGLE-POLE KEYED SWITCH
S _{K3}	KEYED, 3-WAY SWITCH
S _{K4}	KEYED, 4-WAY SWITCH
S _{MC}	MOMENTARY CONTACT SWITCH
S _{PROJ}	MOTORIZED PROJECTION SCREEN RAISE/LOWER SWITCH
S _O	OCCUPANCY SENSOR SWITCH
S_O	CEILING MOUNTED OCCUPANCY SENSOR
C	CONTACTOR, COMPLETE WITH NEMA ENCLOSURE
TC	TIME CLOCK, AS INDICATED ON PLANS
PC	PHOTOCELL
•	PUSHBUTTON SWITCH
E,G H	EMERGENCY SHUT-OFF SWITCH. SUBLETTER "E" INDICATES ELECTRICAL. SUBLETTER "G" INDICATES GAS
KE,KG H	MASTER EMERGENCY SHUT-OFF/KEYED RESET SWITCH. SUBLETTER "KE" INDICATES ELECTRICAL. SUBLETTER "KG" INDICATES GAS

FIGURE 1.7 Electrical symbols. (Continued)































POWER	
	DUPLEX RECEPTACLE; SUBLETTER "a" INDICATES RECEPTACLE TO BE MOUNTED 6" ABOVE COUNTER TOP OR 48" AFF. SUBLETTER "b" INDICATES MOUNTED IN ARCHITECTURAL MILLWORK. COORDINATE INSTALLATION WITH ARCHITECT.
	DOUBLE DUPLEX RECEPTACLE; SUBLETTER "a" INDICATES RECEPTACLE TO BE MOUNTED 6" ABOVE COUNTER TOP OR 48" AFF. SUBLETTER "b" INDICATES MOUNTED IN ARCHITECTURAL MILLWORK. COORDINATE INSTALLATION WITH ARCHITECT.
	SINGLE RECEPTACLE
	FLOOR MOUNTED DUPLEX RECEPTACLE; SUBLETTER "R" INDICATES RECESSED BACKBOX. SUBLETTER "F" INDICATES FLUSH BACKBOX. SUBLETTER "S" INDICATED SURFACE BACKBOX (MONUMENT)
	DUPLEX RECEPTACLE—ONE OUTLET SWITCHED
	DUPLEX RECEPTACLE. SUBLETTER "c" INDICATES CEILING MOUNTED
	DUPLEX RECEPTACLE FOR TELEVISION. MOUNTING HEIGHT AS NOTED ON PLANS
	ELECTRICAL FLOOR MONUMENT WITH LFMC WHIP CONNECTION
	SPECIAL-PURPOSE OUTLET. AMPERAGE AND VOLTAGE AS INDICATED ON PLANS. VERIFY NEMA CONFIGURATION WITH EQUIPMENT MANUFACTURER
	DUPLEX RECEPTACLE, EMERGENCY POWER; SUBLETTER "a" INDICATES RECEPTACLE TO BE MOUNTED 6" ABOVE COUNTER TOP OR 48" AFF. SUBLETTER "b" INDICATES MOUNTED IN ARCHITECTURAL MILLWORK. COORDINATE INSTALLATION WITH ARCHITECT.
	DOUBLE DUPLEX RECEPTACLE, EMERG. POWER; SUBLETTER "a" INDICATES RECEPTACLE TO BE MOUNTED 6" ABOVE COUNTER TOP OR 48" AFF. SUBLETTER "b" INDICATES MOUNTED IN ARCHITECTURAL MILLWORK. COORDINATE INSTALLATION WITH ARCHITECT.
	SURFACE RACEWAY WITH OUTLETS AS INDICATED ON PLANS. MOUNTED AT 18" AFF. UNLESS OTHERWISE NOTED
	TELEPHONE/POWER POLE
	ELECTRICAL PANEL 480/277 VOLT
	ELECTRICAL PANEL 120/208 VOLT
	SPECIAL-PURPOSE ELECTRICAL PANEL OR EQUIPMENT
	ELECTRICAL POWER TRANSFORMER
	MAGNETIC STARTER
	FUSED DISCONNECT SWITCH WITH SIZE/RATING
	NON-FUSED DISCONNECT SWITCH
	COMBINATION MAGNETIC STARTER AND DISCONNECT SWITCH
	ELECTRIC MOTOR
	VARIABLE FREQUENCY DRIVE
	FLOOR OR CEILING MOUNTED JUNCTION BOX
	WALL MOUNTED JUNCTION BOX
	ELECTRIFIED BUS DUCT WITH FUSIBLE, PLUG-IN, BRANCH CIRCUIT DEVICE
	HARD-WIRED EQUIPMENT CONNECTION
	RELAY
	ELECTRIC DOOR OPENER
	ELECTRIC DOOR OPENER ACTUATOR PUSH PLATE

FIGURE 1.7 Electrical symbols. (Continued)























SPECIAL SYSTEMS	
SYMBOL	DESCRIPTION
 R,F,S	FLOOR MOUNTED TEL/DATA OUTLET; SUBLETTER "R" INDICATES RECESSED BACKBOX. SUBLETTER "F" INDICATES FLUSH BACKBOX. SUBLETTER "S" INDICATED SURFACE BACKBOX (MONUMENT)
	COMMUNICATIONS FLOOR MONUMENT WITH LFMC WHIP CONNECTION
	COMBINATION DATA/TELEPHONE OUTLET WITH BACKBOX AND EMPTY CONDUIT STUBBED UP TO ABOVE FINISHED CEILING, INCLUDING DRAG LINE
W 	TELEPHONE OUTLET WITH BACKBOX AND EMPTY CONDUIT, STUBBED UP TO ABOVE FINISHED CEILING, INCLUDING DRAG LINE. SUBLETTER "W" INDICATES WALL-MOUNTED;
 HP	HANDICAP PAY TELEPHONE OUTLET WITH BACKBOX AND CONDUIT STUBBED UP TO ABOVE FINISHED CEILING, INCLUDING DRAG LINE
	DATA OUTLET WITH BACKBOX AND EMPTY CONDUIT STUBBED UP TO ABOVE FINISHED CEILING, INCLUDING DRAGLINE
	TELEVISION CABLE OUTLET; MOUNT AT 18" AFF UNLESS OTHERWISE NOTED.
	CEILING-MOUNTED, SOUND SYSTEM SPEAKER
	WALL-MOUNTED, SOUND SYSTEM SPEAKER
	SOUND SYSTEM VOLUME CONTROLLER
 F,W	SOUND SYSTEM MICROPHONE JACK; SUBLETTER "F" INDICATES FLOOR-MOUNTED. SUBLETTER "W" INDICATES WALL-MOUNTED
	PA/SOUND SYSTEM HANDSET
	PA/SOUND SYSTEM CLOCK AND SPEAKER MOUNTED IN COMMON ENCLOSURE
	WALL CLOCK WITH HANGER TYPE OUTLET
	PROGRAM BELL
 E	EMERGENCY CALL-FOR-AID AUDIO INDICATING UNIT
 E _{PC}	EMERGENCY CALL-FOR-AID SWITCH
 E _{PB}	EMERGENCY CALL-FOR-AID PUSHBUTTON
	EMERGENCY CALL-FOR-AID VISUAL INDICATING UNIT
 E	EMERGENCY CALL-FOR-AID VISUAL/AUDIO INDICATING UNIT
	AMPLIFIER
 I _M	INTERCOM STATION; SUBLETTER "M" INDICATES MASTER



FIGURE 1.7 Electrical symbols. (Continued)

HOSPITAL SYMBOLS	
SYMBOL	DESCRIPTION
N _{1/2}	NURSE CALL BEDSIDE STATION – SUBNUMBER INDICATES SINGLE OR DOUBLE BED
N _E	EMERGENCY NURSE CALL STATION
N _{M/S}	NURSE CALL MICROPHONE/SPEAKER UNIT
N _{SR}	NURSE CALL STAFF REGISTER
N _{ACU}	NURSE CALL AREA CONTROL UNIT
N _{FCS}	NURSE CALL FLOOR CONTROL STATION
N _B	NURSE CALL CODE BLUE
N _{SS}	NURSE CALL STAFF STATION
N _{DS}	NURSE CALL DUTY STATION
FM	FETAL MONITORING STATION
PM	PATIENT MONITORING STATION
D _N H _D N	NURSE CALL CORRIDOR DOME LIGHT – CEILING OR WALL MOUNTED.
D _Z H _D Z	NURSE CALL CORRIDOR ZONE LIGHT – CEILING OR WALL MOUNTED.
TA	TELEMETRY RECEIVER
CTM	CENTRAL TELEMETRY UNIT
PU _{NC/PM}	PRINTER UNIT, SUBLETTER "NC" INDICATES NURSE CALL; SUBLETTER "PM" INDICATES PATIENT MONITOR
MGAP	MEDICAL GAS ALARM PANEL
CMS	CENTRAL PATIENT MONITOR STATION

FIGURE 1.7 Electrical symbols. (Continued)

FIRE	
M	FIRE ALARM MAGNETIC DOOR HOLD DEVICE
FS	SPRINKLER FIRE ALARM FLOW SWITCH
SS	SPRINKLER FIRE ALARM SUPERVISORY SWITCH
PS	SPRINKLER FIRE ALARM PRESSURE SWITCH
F	MASTER FIRE ALARM PULL BOX
S _E	SMOKE DETECTOR FOR ELEVATOR RECALL CONTROLS
☒	EXTERIOR REMOTE FIRE ALARM FLASHING STROBE LIGHT
FACP	FIRE ALARM CONTROL PANEL
RAP	REMOTE ANNUNCIATOR PANEL
F	MANUAL FIRE ALARM PULL STATION
■	FIRE ALARM VISUAL INDICATING UNIT
■◀	FIRE ALARM AUDIO/VISUAL INDICATING UNIT
■◀ _S	FIRE ALARM SPEAKER/VISUAL INDICATING UNIT (VOICE EVAC. SYSTEM)
⊙	FIRE ALARM CEILING-MOUNTED SPEAKER
■◀ _M	FIRE ALARM MINI SPEAKER
H _B	AUTOMATIC FIRE ALARM HEAT DETECTOR. SUBLETTER "B" INDICATES 200 DEGREES F. HEAT DETECTOR
▶ _{FP}	FIREFIGHTERS TELEPHONE OUTLET
▶ _{ADR}	AREA OF REFUGE TELEPHONE OUTLET
▶ _{EM}	EMERGENCY TELEPHONE OUTLET
S	AUTOMATIC FIRE ALARM SMOKE DETECTOR
S _S	AUTOMATIC FIRE ALARM SMOKE DETECTOR WITH SOUNDER BASE
DS	DUCT SMOKE FIRE ALARM DETECTOR
DH	DUCT HEAT FIRE ALARM DETECTOR
TS	SMOKE DETECTOR TEST SWITCH

FIGURE 1.7 Electrical symbols. (Continued)

SECURITY	
ES	DOOR STRIKE
	DOOR/WINDOW CONTACT
	VIDEO CAMERA, WITH MOUNTING HARDWARE
VM	VIDEO MONITOR
VR	VIDEO RECORDER
CR	CARD READER
	CEILING OR WALL-MOUNTED MOTION DETECTOR







WIRING	
	BRANCH CIRCUIT POWER WIRING
	BRANCH CIRCUIT SWITCHED WIRING
	BRANCH CIRCUIT AC OR DC CONTROL WIRING
	BRANCH CIRCUIT EMERGENCY AC OR DC WIRING. 3/4" CONDUIT, 2#10 AND 1#10 GROUND, UNLESS OTHERWISE NOTED
	CABLETRAY
	CONDUIT DOWN
	CONDUIT UP
	HOME RUN. 3/4" CONDUIT, 2#12 AND 1#12 GROUND, UNLESS OTHERWISE NOTED. NOTE: HOME RUN SHALL BE FROM FIRST ELECTRICAL DEVICE BACKBOX IN CIRCUIT TO ELECTRICAL PANEL

FIGURE 1.7 Electrical symbols. (Continued)

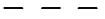



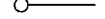



















ONE-LINE	
	POTHEAD
	STRESSCONE
	CURRENT TRANSFORMER
	POTENTIAL TRANSFORMER
	FUSE
	FUSE CUT OUT
	FUSE & SWITCH
	SWITCH
	CIRCUIT BREAKER
	DRAWOUT CIRCUIT BREAKER
	MEDIUM VOLTAGE DRAWOUT CIRCUIT BREAKER
	BUSPLUG CIRCUIT BREAKER
	BUSPLUG FUSE & SWITCH
	GROUND
	THERMAL OVERLOAD
	RELAY/COIL
	N/O CONTACT
	N.C. CONTACT
	PROTECTIVE RELAY
	AMMETER
	AMMETER SWITCH
	VOLTMETER
	VOLTMETER SWITCH
	WATTHOUR METER
	WATTMETER

FIGURE 1.7 Electrical symbols. (Continued)















ONE-LINE	
	WATTHOUR DEMAND METER
	TRANSFORMER
	SHIELDED TRANSFORMER
	AUTO TRANSFORMER
	LIGHTNING ARRESTER
	GENERATOR
	DELTA
	WYE
	KEY INTERLOCK
	AUTOMATIC TRANSFER SWITCH (A.T.S.)
	MAIN LUG ONLY PANELBOARD
	MAIN CIRCUIT BREAKER PANELBOARD
	CIRCUIT BREAKER WITH AMP FRAME OVER AMP TRIP
	FUSED DISCONNECT SWITCH, WITH SWITCH SIZE OVER FUSE SIZE

FIGURE 1.7 Electrical symbols. (Continued)

ABBREVIATIONS	
SYMBOL	DESCRIPTION
A	AMPERE
C	CONDUIT
P	POLE
W	WIRE
T	TELEPHONE SERVICE
FA	FIRE ALARM
NF	NON-FUSED
WP	WEATHERPROOF
C/B	CIRCUIT BREAKER
AFF	ABOVE FINISHED FLOOR
AFG	ABOVE FINISHED GRADE
CIR	CIRCUIT
TX	TRANSFORMER
MD	MOTORIZED DAMPER
PE	PRIMARY ELECTRIC SERVICE
SE	SECONDARY ELECTRIC SERVICE
RTU	ROOFTOP UNIT
TCP	TEMPERATURE CONTROL PANEL
SD	SMOKE DAMPER
IG	ISOLATED GROUND
RMC	RIGID METALLIC CONDUIT
EMT	ELECTRIC METALLIC TUBING

FIGURE 1.7 Electrical symbols. (Continued)

ABBREVIATIONS	
SYMBOL	DESCRIPTION
FMC	FLEXIBLE METALLIC TUBING
TV	TELEVISION
PVC	POLYVINYL CHLORIDE CONDUIT
EF	EXHAUST FAN
REF	ROOF EXHAUST FAN
AHU	AIR HANDLING UNIT
CUH	CABINET UNIT HEATER
EWC	ELECTRIC WATER COOLER
EWH	ELECTRIC WATER HEATER
GFI	GROUND FAULT INTERRUPTER
MAU	MAKE-UP AIR UNIT
WG	WIRE GUARD
S&P	SPACE AND PROVISION
E	EXISTING TO REMAIN
RE	REMOVE EXISTING
RL	RELOCATE EXISTING
NL	NEW LOCATION OF EXISTING RELOCATED
NR	NEW TO REPLACE EXISTING
RR	REMOVE AND REPLACE ON NEW SURFACE

Mounting Heights

Mounting heights of electrical devices are influenced by and must be closely coordinated with the architectural design. However, there are industry standard practices followed by architects as well as code and legal requirements, such as Americans with Disabilities Act (ADA) guidelines. The following recommended mounting heights for electrical devices provide a good guideline in the absence of any specific information and are ADA compliant.

TABLE 1.1 Mounting Heights for Electrical Devices

	<u>DEVICE</u>	<u>MOUNTING HEIGHTS</u>
1.	Light switches, wall mounted occupancy sensors	48" to centerline of box Exception: 44" maximum to top above counters which are 20"-25"D.
2.	Wall mounted exit signs	90" to centerline of sign or centered in wall area between top of door and ceiling.
2A.	Ceiling mounted exit signs and pendant mounted fixtures.	80" to bottom of fixture.
3.	Receptacles	16" to bottom of box Exception: 44" maximum to top above counters which are 20"-25"D.
4.	Special outlets or receptacles	16" to bottom of box or as noted on drawings Exception: 44" maximum to top above counters which are 20"-25"D.
5.	Plugmold or Wiremold	As noted on drawings. Exception: 44" maximum to top above counters which are 20"-25"D.

TABLE 1.1 Mounting Heights for Electrical Devices (*Continued*)

6.	Clock outlets	12" from ceiling to centerline or 7'-0" to centerline if ceiling is over 8'-0"
7.	Data/communication or telephone outlets	16" to bottom of box Exception: 44" maximum to top above counters which are 20"- 25"D.
8.	Telephone outlets - wall type	54" to Dial Center (non- accessible) 48" to highest operable part (accessible)
9.	Pay type telephone outlets	48" maximum to coin slot
10.	Fire alarm manual pull stations	48" to centerline of box - not more than 5' - 0" from exit
11.	Combination fire alarm audio/visual units	80" to bottom of backbox or 6" below ceiling to top of backbox, whichever is lower, so that entire lens is within the 80"-96" area required by ADA and NFPA 72, spacing shall be such that no point is more than 50' away without obstruction
12.	Wall mounted remote indicator light	80" to centerline of device or 6" below ceiling, whichever is lower
13.	Area of Refuge Telephone	Same as telephone - accessible
14.	Call-For-Aid switch with pull chain to floor	48" to centerline of box minimum (toilets) 66" to centerline of box maximum (showers - located out of spray area)
15.	Card reader	48" to highest operable part (side or forward access)
16.	Intercom station	54" to highest operable part (side access) 48" highest operable part (forward access)

TABLE 1.1 Mounting Heights for Electrical Devices (*Continued*)

17.	Sound system volume control	54" to highest operable part (side access) 48" to highest operable part (forward access)
18.	Microphone outlets	16" to bottom of box
19.	Thermostats	54" to highest operable part (side access) 48" to highest operable part (forward access)
20.	Temperature/Humidity Sensors	60" to center line of box

- NOTES:**
1. All dimensions are considered from finished floor and, unless noted otherwise, shall not vary.
 2. All dimensions shall be coordinated with architectural details and may be adjusted to conform with architectural requirements as long as no code restriction is violated.
 3. Outlets installed lower than 15" AFF (forward reach) and 9" AFF (side reach) are in violation of ADA.

SPECIAL NOTES:

1. Exit signs shall NOT be installed so that it blocks fire alarm visual devices.
2. Wall mounted light fixtures:
 - a. Bottom of fixture at 80" AFF, or greater.
 - b. Bottom of fixture at less than 80" AFF, protrusion into space shall be no more than 4".
3. Where floor proximity exit signs are required by NFPA 101, the bottom shall not be less than 6" or higher than 8" above floor.
4. For fire alarm, if you can't make your installation work with these requirements or you are just not sure if it's right or not, REFER TO NFPA 72 AND/OR ADA.

1.3 NEMA DEVICE CONFIGURATIONS

Nonlocking

FIGURE 1.8 Configuration chart for general-purpose nonlocking plugs and receptacles.

	15 AMPERE		20 AMPERE		30 AMPERE		50 AMPERE		60 AMPERE		
	RECEPTACLE	PLUG	RECEPTACLE	PLUG	RECEPTACLE	PLUG	RECEPTACLE	PLUG	RECEPTACLE	PLUG	
2-POLE 2-WIRE	1 125 V										
	2 250 V										
	3 277 V										
	4 600 V										
2-POLE 3-WIRE CONFIGURING	5 125 V										
	6 250 V										
	7 277 V AC										
	8 347 V AC										
	9 480 V AC										
	10 600 V AC										
	11 250 V										
	12 480 V										
3-POLE 3-WIRE	13 600 V										
	14 125 V										
	15 250 V										
	16 480 V										
3-POLE 4-WIRE CONFIGURING	17 600 V										
	18 125 V										
	19 250 V										
4-POLE 3-WIRE	20 480 V										
	21 600 V										
	22 208 V										
4-POLE 4-WIRE CONFIGURING	23 277 V										
	24 600 V										
	25 347 V										

(©1999, NFPA)

Locking

FIGURE 1.9 Configuration chart for specific-purpose locking plugs and receptacles.

		15 AMPERE		20 AMPERE		30 AMPERE		50 AMPERE		60 AMPERE		
		RECEPTACLE	PLUG	RECEPTACLE	PLUG	RECEPTACLE	PLUG	RECEPTACLE	PLUG	RECEPTACLE	PLUG	
2-POLE 3-WIRE	1	125 V L1-15R	L1-15P									
	2	250 V		L2-20R	L2-20P							
	3	277 V										
	4	600 V										
(RESERVED FOR FUTURE CONFIGURATIONS)												
2-POLE 3-WIRE GROUNDING	5	125 V	L5-15R	L5-15P	L5-20R	L5-20P	L5-30R	L5-30P	L5-50R	L5-50P	L5-60R	L5-60P
	6	250 V	L6-15R	L6-15P	L6-20R	L6-20P	L6-30R	L6-30P	L6-50R	L6-50P	L6-60R	L6-60P
	7	277 V AC	L7-15R	L7-15P	L7-20R	L7-20P	L7-30R	L7-30P	L7-50R	L7-50P	L7-60R	L7-60P
	8	347 V AC			L24-20R	L24-20P						
	9	480 V AC			L8-20R	L8-20P	L8-30R	L8-30P	L8-50R	L8-50P	L8-60R	L8-60P
	10	600 V AC			L9-20R	L9-20P	L9-30R	L9-30P	L9-50R	L9-50P	L9-60R	L9-60P
	11	125-250 V	L11-15R	L11-15P	L11-20R	L11-20P	L11-30R	L11-30P	L11-50R	L11-50P	L11-60R	L11-60P
	12	3 ø 480 V			L12-20R	L12-20P	L12-30R	L12-30P				
	13	3 ø 600 V					L13-30R	L13-30P				
3-POLE 3-WIRE GROUNDING	14	125-250 V			L14-20R	L14-20P	L14-30R	L14-30P	L14-50R	L14-50P	L14-60R	L14-60P
	15	3 ø 250 V			L15-20R	L15-20P	L15-30R	L15-30P	L15-50R	L15-50P	L15-60R	L15-60P
	16	3 ø 480 V			L16-20R	L16-20P	L16-30R	L16-30P	L16-50R	L16-50P	L16-60R	L16-60P
	17	3 ø 600 V					L17-30R	L17-30P	L17-50R	L17-50P	L17-60R	L17-60P
	18	3 ø 208 V 120 V			L18-20R	L18-20P	L18-30R	L18-30P	L18-50R	L18-50P	L18-60R	L18-60P
4-POLE 3-WIRE	19	3 ø 480 V 277 V			L19-20R	L19-20P	L19-30R	L19-30P				
	20	3 ø 600 V			L20-20R	L20-20P	L20-30R	L20-30P				
	21	3 ø 208 V 120 V			L21-20R	L21-20P	L21-30R	L21-30P	L21-50R	L21-50P	L21-60R	L21-60P
4-POLE 3-WIRE GROUNDING	22	3 ø 480 V 277 V			L22-20R	L22-20P	L22-30R	L22-30P	L22-50R	L22-50P	L22-60R	L22-60P
	23	3 ø 600 V 347 V			L23-20R	L23-20P	L23-30R	L23-30P	L23-50R	L23-50P	L23-60R	L23-60P

(©1999, NFPA)

1.4 IEEE STANDARD ELECTRICAL POWER SYSTEM DEVICE FUNCTION NUMBERS AND CONTACT DESIGNATIONS

FIGURE 1.10

IEEE Standard Electrical Power System Device Function Numbers and Contact Designations

1. Overview

1.1 Scope

This standard applies to the definition and application of function numbers for devices used in electrical substations and generating plants and in installations of power utilization and conversion apparatus.

NOTE — In the past, device function numbers have typically represented individual or component devices. These numbers may also be used to represent functions in microprocessor-based devices or software programs.

1.2 Purpose

A device function number, with an appropriate prefix and appended suffix is used to identify the function(s) of each device installed in electrical equipment. This includes manual, partial-automatic, and automatic switchgear. These numbers are to be used in drawings, elementary and connection diagrams, instruction books, publications, and specifications. In addition, for automatic switchgear, the device number may be physically placed on, or adjacent to, each device on the assembled equipment. This will enable a device to be readily identified.

NOTE — These device function designations have been developed as a result of usage over many years. They may define the actual function the device performs in equipment or they may refer to the electrical or other quantity to which the device is responsive. Hence, in some instances, there may be a choice of the function number to be used for a given device. The preferable choice to be made should be the function number that is recognized to have the narrowest interpretation in all cases. The choice should specifically identify a device in the minds of all individuals concerned with the design and operation of the equipment.

36 Electrical Engineer's Portable Handbook

FIGURE 1.10 (Continued)

IEEE Std C37.2-1996

IEEE STANDARD ELECTRICAL POWER SYSTEM DEVICE

2. References

This standard shall be used in conjunction with the following publications. When the following standards are superseded by an approved revision, the revision shall apply.

ASME Y1.1-1989, Abbreviations for Use on Drawings and in Text.¹

IEEE Std 315-1975, (Reaff 1993) IEEE Standard Graphic Symbols for Electrical and Electronics Diagrams (ANSI).²

IEEE Std C37.20.1-1993, IEEE Standard for Metal-Enclosed Low-Voltage Power Circuit Breaker Switchgear (ANSI).

IEEE Std C37.20.2-1993, IEEE Standard for Metal-Clad and Station-Type Cubicle Switchgear (ANSI).

3. Standard device function number descriptions

3.1 Standard device function numbers

Each number, with its corresponding function name and a general description of the function, is listed below. An index of device function names consisting of the corresponding device numbers and page numbers is provided on page 33.

NOTE — When alternate names and descriptions are included under the function, only the name and description that applies to each specific case should be used. In general, only one name for each device, such as relay, contactor, circuit breaker, switch, or monitor, is included in each function designation. However, when the function is not inherently restricted to any specific type of device, and where the type of device itself is thus merely incidental, any one of the above listed alternative names, as applicable, may be substituted. For example, if for device function 6 a contactor is used for the purpose in place of a circuit breaker, the function name should be specified as “starting contactor.”

For every application of device function numbers, the originator should provide a brief definition for all device function numbers used in that application, including all combinations of prefixes, function numbers, and suffixes. Typical definitions are illustrated in Figures 3 and 4. These definitions should be included in the drawing where the device function number is used, or in a separate drawing or list to which the other drawings refer. All instruction books and other documents shall also include the device function number definitions.

Numbers from 95 through 99 should be assigned only for those functions in specific cases where none of the assigned standard device function numbers are applicable. Numbers that are “reserved for future application” should not be used.

3.1.1 Device number 1—master element

A device, such as a control switch, etc., that serves, either directly or through such permissive devices as protective and time-delay relays, to place equipment in or out of operation.

NOTE — This number is normally used for a hand-operated device, although it may also be used for an electrical or mechanical device for which no other function number is suitable.

¹ASME publications are available from the American Society of Mechanical Engineers, 22 Law Drive, Fairfield, NJ, 07007, USA.

²IEEE publications are available from the Institute of Electrical and Electronics Engineers, Service Center, 445 Hoes Lane, P.O. Box 1331, Piscataway, NJ 08855-1331, USA.

FIGURE 1.10 (Continued)

FUNCTION NUMBERS AND CONTACT DESIGNATIONS

IEEE Std C37.2-1996

3.1.2 Device number 2—time-delay starting or closing relay

A device that functions to give a desired amount of time delay before or after any point of operation in a switching sequence or protective relay system, except as specifically provided by device functions 48, 62, 79, and 82.

3.1.3 Device number 3—checking or interlocking relay

A device that operates in response to the position of one or more other devices or predetermined conditions in a piece of equipment or circuit, to allow an operating sequence to proceed, or to stop, or to provide a check of the position of these devices or conditions for any purpose.

3.1.4 Device number 4—master contactor

A device, generally controlled by device function 1 or the equivalent and the required permissive and protective devices, that serves to make and break the necessary control circuits to place equipment into operation under the desired conditions and to take it out of operation under abnormal conditions.

3.1.5 Device number 5—stopping device

A control device used primarily to shut down equipment and hold it out of operation. (This device may be manually or electrically actuated, but it excludes the function of electrical lockout [see device function 86] on abnormal conditions.)

3.1.6 Device number 6—starting circuit breaker

A device whose principal function is to connect a machine to its source of starting voltage.

3.1.7 Device number 7—rate-of-change relay

A device that operates when the rate-of-change of the measured quantity exceeds a threshold value, except as defined by device 63 (see 3.1.63).

3.1.8 Device number 8—control power disconnecting device

A device, such as a knife switch, circuit breaker, or pull-out fuse block, used for the purpose of connecting and disconnecting the source of control power to and from the control bus or equipment.

NOTE — Control power is considered to include auxiliary power that supplies such apparatus as small motors and heaters.

3.1.9 Device number 9—reversing device

A device that is used for the purpose of reversing a machine field or for performing any other reversing function.

3.1.10 Device number 10—unit sequence switch

A device that is used to change the sequence in which units may be placed in and out of service in multiple-unit equipment.

3.1.11 Device number 11—multifunction device

A device that performs three or more comparatively important functions that could only be designated by combining several device function numbers. All of the functions performed by device 11 shall be defined in the drawing legend, device function definition list or relay setting record. See Annex B for further discussion and examples.

38 Electrical Engineer's Portable Handbook

FIGURE 1.10 (Continued)

IEEE Std C37.2-1996

IEEE STANDARD ELECTRICAL POWER SYSTEM DEVICE

NOTE — If only two relatively important functions are performed by the device, it is preferred that both function numbers be used, as described in 3.6.

3.1.12 Device number 12—overspeed device

A device, usually direct connected, that operates on machine overspeed.

3.1.13 Device number 13—synchronous-speed device

A device such as a centrifugal-speed switch, a slip-frequency relay, a voltage relay, an undercurrent relay, or any other type of device that operates at approximately the synchronous speed of a machine.

3.1.14 Device number 14—underspeed device

A device that functions when the speed of a machine falls below a predetermined value.

3.1.15 Device number 15—speed or frequency matching device

A device that functions to match and hold the speed or frequency of a machine or a system equal to, or approximately equal to, that of another machine, source, or system.

3.1.16 Device number 16—not used

Reserved for future application.

3.1.17 Device number 17—shunting or discharge switch

A device that serves to open or close a shunting circuit around any piece of apparatus (except a resistor), such as a machine field, a machine armature, a capacitor, or a reactor.

NOTE — This excludes devices that perform such shunting operations as may be necessary in the process of starting a machine by devices 6 or 42 (or their equivalent) and also excludes device function 73 that serves for the switching of resistors.

3.1.18 Device number 18—accelerating or decelerating device

A device that is used to close or cause the closing of circuits that are used to increase or decrease the speed of a machine.

3.1.19 Device number 19—starting-to-running transition contactor

A device that operates to initiate or cause the automatic transfer of a machine from the starting to the running power connection.

3.1.20 Device number 20—electrically operated valve

An electrically operated, controlled, or monitored device used in a fluid, air, gas, or vacuum line.

NOTE — The function of the valve may be more completely indicated by the use of suffixes as discussed in 3.2.

3.1.21 Device number 21—distance relay

A device that functions when the circuit admittance, impedance, or reactance increases or decreases beyond a predetermined value.

FIGURE 1.10 (Continued)

FUNCTION NUMBERS AND CONTACT DESIGNATIONS

IEEE Std C37.2-1996

3.1.22 Device number 22—equalizer circuit breaker

A device that serves to control or make and break the equalizer or the current-balancing connections for a machine field, or for regulating equipment, in a multiple-unit installation.

3.1.23 Device number 23—temperature control device

A device that functions to control the temperature of a machine or other apparatus, or of any medium, when its temperature falls below or rises above a predetermined value.

NOTE — An example is a thermostat that switches on a space heater in a switchgear assembly when the temperature falls to a desired value. This should be distinguished from a device that is used to provide automatic temperature regulation between close limits and would be designated as device function 90T.

3.1.24 Device number 24—volts per hertz relay

A device that operates when the ratio of voltage to frequency is above a preset value or is below a different preset value. The relay may have any combination of instantaneous or time delayed characteristics.

3.1.25 Device number 25—synchronizing or synchronism-check relay

A synchronizing device produces an output that causes closure at zero-phase angle difference between two circuits. It may or may not include voltage and speed control. A synchronism-check relay permits the paralleling of two circuits that are within prescribed limits of voltage magnitude, phase angle, and frequency.

3.1.26 Device number 26—apparatus thermal device

A device that functions when the temperature of the protected apparatus (other than the load-carrying windings of machines and transformers as covered by device function number 49) or of a liquid or other medium exceeds a predetermined value; or when the temperature of the protected apparatus or of any medium decreases below a predetermined value.

3.1.27 Device number 27—undervoltage relay

A device that operates when its input voltage is less than a predetermined value.

3.1.28 Device number 28—flame detector

A device that monitors the presence of the pilot or main flame in such apparatus as a gas turbine or a steam boiler.

3.1.29 Device number 29—isolating contactor or switch

A device that is used expressly for disconnecting one circuit from another for the purposes of emergency operation, maintenance, or test.

3.1.30 Device number 30—annunciator relay

A nonautomatically reset device that gives a number of separate visual indications upon the functioning of protective devices and that may also be arranged to perform a lockout function.

3.1.31 Device number 31—separate excitation device

A device that connects a circuit, such as the shunt field of a synchronous converter, to a source of separate excitation during the starting sequence.

FIGURE 1.10 (Continued)

IEEE Std C37.2-1996

IEEE STANDARD ELECTRICAL POWER SYSTEM DEVICE

3.1.32 Device number 32—directional power relay

A device that operates on a predetermined value of power flow in a given direction such as reverse power flow resulting from the motoring of a generator upon loss of its prime mover.

3.1.33 Device number 33—position switch

A device that makes or breaks contact when the main device or piece of apparatus that has no device function number reaches a given position.

3.1.34 Device number 34—master sequence device

A device such as a motor-operated multi-contact switch, or the equivalent, or a programmable device, that establishes or determines the operating sequence of the major devices in equipment during starting and stopping or during sequential switching operations.

3.1.35 Device number 35—brush-operating or slip-ring short-circuiting device

A device for raising, lowering, or shifting the brushes of a machine; short-circuiting its slip rings; or engaging or disengaging the contacts of a mechanical rectifier.

3.1.36 Device number 36—polarity or polarizing voltage device

A device that operates, or permits the operation of, another device on a predetermined polarity only or that verifies the presence of a polarizing voltage in equipment.

3.1.37 Device number 37—undercurrent or underpower relay

A device that functions when the current or power flow decreases below a predetermined value.

3.1.38 Device number 38—bearing protective device

A device that functions on excessive bearing temperature or on other abnormal mechanical conditions associated with the bearing, such as undue wear, which may eventually result in excessive bearing temperature or failure.

3.1.39 Device number 39—mechanical condition monitor

A device that functions upon the occurrence of an abnormal mechanical condition (except that associated with bearings as covered under device function 38), such as excessive vibration, eccentricity, expansion, shock, tilting, or seal failure.

3.1.40 Device number 40—field relay

A device that functions on a given or abnormally high or low value or failure of machine field current, or on an excessive value of the reactive component of armature current in an ac machine indicating abnormally high or low field excitation.

3.1.41 Device number 41—field circuit breaker

A device that functions to apply or remove the field excitation of a machine.

FIGURE 1.10 (Continued)

FUNCTION NUMBERS AND CONTACT DESIGNATIONS

IEEE Std C37.2-1996

3.1.42 Device number 42—running circuit breaker

A device whose function is to connect a machine to its source of running or operating voltage. This function may also be used for a device, such as a contactor, that is used in series with a circuit breaker or other fault-protecting means, primarily for frequent opening and closing of the circuit.

3.1.43 Device number 43—manual transfer or selector device

A manually operated device that transfers control or potential circuits in order to modify the plan of operation of the associated equipment or of some of the associated devices.

3.1.44 Device number 44—unit sequence starting relay

A device that functions to start the next available unit in multiple-unit equipment upon the failure or non-availability of the normally preceding unit.

3.1.45 Device number 45—atmospheric condition monitor

A device that functions upon the occurrence of an abnormal atmospheric condition, such as damaging fumes, explosive mixtures, smoke, or fire.

3.1.46 Device number 46—reverse-phase or phase-balance current relay

A device in a polyphase circuit that operates when the polyphase currents are of reverse-phase sequence or when the polyphase currents are unbalanced or when the negative phase-sequence current exceeds a preset value.

3.1.47 Device number 47—phase-sequence or phase-balance voltage relay

A device in a polyphase circuit that functions upon a predetermined value of polyphase voltage in the desired phase sequence, when the polyphase voltages are unbalanced, or when the negative phase-sequence voltage exceeds a preset value.

3.1.48 Device number 48—incomplete sequence relay

A device that generally returns the equipment to the normal or off position and locks it out if the normal starting, operating, or stopping sequence is not properly completed within a predetermined time.

3.1.49 Device number 49—machine or transformer thermal relay

A device that functions when the temperature of a machine armature winding or other load-carrying winding or element of a machine or power transformer exceeds a predetermined value.

3.1.50 Device number 50—instantaneous overcurrent relay

A device that operates with no intentional time delay when the current exceeds a preset value.

3.1.51 Device number 51—ac time overcurrent relay

A device that functions when the ac input current exceeds a predetermined value, and in which the input current and operating time are inversely related through a substantial portion of the performance range.

42 Electrical Engineer's Portable Handbook

FIGURE 1.10 (Continued)

IEEE Std C37.2-1996

IEEE STANDARD ELECTRICAL POWER SYSTEM DEVICE

3.1.52 Device number 52—ac circuit breaker

A device that is used to close and interrupt an ac power circuit under normal conditions or to interrupt this circuit under fault or emergency conditions.

3.1.53 Device number 53—exciter or dc generator relay

A device that forces the dc machine field excitation to build up during starting or that functions when the machine voltage has built up to a given value.

3.1.54 Device number 54—turning gear engaging device

A device either electrically operated, controlled, or monitored that functions to cause the turning gear to engage (or disengage) the machine shaft.

3.1.55 Device number 55—power factor relay

A device that operates when the power factor in an ac circuit rises above or falls below a predetermined value.

3.1.56 Device number 56—field application relay

A device that automatically controls the application of the field excitation to an ac motor at some predetermined point in the slip cycle.

3.1.57 Device number 57—short-circuiting or grounding device

A device that functions to short-circuit or ground a circuit in response to automatic or manual means.

3.1.58 Device number 58—rectification failure relay

A device that functions if a power rectifier fails to conduct or block properly.

3.1.59 Device number 59—overvoltage relay

A device that operates when its input voltage exceeds a predetermined value.

3.1.60 Device number 60—voltage or current balance relay

A device that operates on a given difference in voltage, or current input or output, of two circuits.

3.1.61 Device number 61—density switch or sensor

A device that operates at a given density value or at a given rate of change of density.

3.1.62 Device number 62—time-delay stopping or opening relay

A device that imposes a time delay in conjunction with the device that initiates the shutdown, stopping, or opening operation in an automatic sequence or protective relay system.

3.1.63 Device number 63—pressure switch

A device that operates at a given pressure value or at a given rate of change of pressure.

FIGURE 1.10 (Continued)

FUNCTION NUMBERS AND CONTACT DESIGNATIONS

IEEE Std C37.2-1996

3.1.64 Device number 64—ground detector relay

A device that operates upon failure of machine or other apparatus insulation to ground.

NOTE — This function is not applied to a device connected in the secondary circuit of current transformers in a normally grounded power system where other overcurrent device numbers with the suffix G or N should be used; for example, 51N for an ac time overcurrent relay connected in the secondary neutral of the current transformers.

3.1.65 Device number 65—governor

A device consisting of an assembly of fluid, electrical, or mechanical control equipment used for regulating the flow of water, steam, or other media to the prime mover for such purposes as starting, holding speed or load, or stopping.

3.1.66 Device number 66—notching or jogging device

A device that functions to allow only a specified number of operations of a given device or piece of equipment, or a specified number of successive operations within a given time of each other. It is also a device that functions to energize a circuit periodically or for fractions of specified time intervals, or that is used to permit intermittent acceleration or jogging of a machine at low speeds for mechanical positioning.

3.1.67 Device number 67—ac directional overcurrent relay

A device that functions at a desired value of ac overcurrent flowing in a predetermined direction.

3.1.68 Device number 68—blocking or “out-of-step” relay

A device that initiates a pilot signal for blocking of tripping on external faults in a transmission line or in other apparatus under predetermined conditions, or cooperates with other devices to block tripping or reclosing on an out-of-step condition or on power swings.

3.1.69 Device number 69—permissive control device

A device with two-positions that in one position permits the closing of a circuit breaker, or the placing of a piece of equipment into operation, and in the other position, prevents the circuit breaker or the equipment from being operated.

3.1.70 Device number 70—rheostat

A device used to vary the resistance in an electric circuit when the device is electrically operated or has other electrical accessories, such as auxiliary, position, or limit switches.

3.1.71 Device number 71—level switch

A device that operates at a given level value, or on a given rate of change of level.

3.1.72 Device number 72—dc circuit breaker

A device that is used to close and interrupt a dc power circuit under normal conditions or to interrupt this circuit under fault or emergency conditions.

3.1.73 Device number 73—load-resistor contactor

A device that is used to shunt or insert a step of load limiting, shifting, or indicating resistance in a power circuit; to switch a space heater in circuit; or to switch a light or regenerative load resistor of a power rectifier or other machine in and out of circuit.

44 Electrical Engineer's Portable Handbook

FIGURE 1.10 (Continued)

IEEE Std C37.2-1996

IEEE STANDARD ELECTRICAL POWER SYSTEM DEVICE

3.1.74 Device number 74—alarm relay

A device other than an annunciator, as covered under device function 30, that is used to operate, or that operates in connection with, a visual or audible alarm.

3.1.75 Device number 75—position changing mechanism

A device that is used for moving a main device from one position to another in equipment; for example, shifting a removable circuit breaker unit to and from the connected, disconnected, and test positions.

3.1.76 Device number 76—dc overcurrent relay

A device that functions when the current in a dc circuit exceeds a given value.

3.1.77 Device number 77—telemetry device

A transmitting device used to generate and transmit to a remote location an electrical signal representing a measured quantity; or a receiver used to receive the electrical signal from a remote transmitter and convert the signal to represent the original measured quantity.

3.1.78 Device number 78—phase-angle measuring relay

A device that functions at a predetermined phase angle between two voltages, between two currents, or between voltage and current.

3.1.79 Device number 79—reclosing relay

A device that controls the automatic reclosing and locking out of an ac circuit interrupter.

3.1.80 Device number 80—flow switch

A device that operates at a given flow value, or at a given rate of change of flow.

3.1.81 Device number 81—frequency relay

A device that responds to the frequency of an electrical quantity, operating when the frequency or rate of change of frequency exceeds or is less than a predetermined value.

3.1.82 Device number 82—dc load-measuring reclosing relay

A device that controls the automatic closing and reclosing of a dc circuit interrupter, generally in response to load circuit conditions.

3.1.83 Device number 83—automatic selective control or transfer relay

A device that operates to select automatically between certain sources or conditions in equipment or that performs a transfer operation automatically.

3.1.84 Device number 84—operating mechanism

A device consisting of the complete electrical mechanism or servomechanism, including the operating motor, solenoids, position switches, etc., for a tap changer, induction regulator, or any similar piece of apparatus that otherwise has no device function number.

FIGURE 1.10 (Continued)

FUNCTION NUMBERS AND CONTACT DESIGNATIONS

IEEE Std C37.2-1996

3.1.85 Device number 85—carrier or pilot-wire relay

A device that is operated or restrained by a signal transmitted or received via any communications media used for relaying.

3.1.86 Device number 86—lockout relay

A device that trips and maintains the associated equipment or devices inoperative until it is reset by an operator, either locally or remotely.

3.1.87 Device number 87—differential protective relay

A device that operates on a percentage, phase angle, or other quantitative difference of two or more currents or other electrical quantities.

3.1.88 Device number 88—auxiliary motor or motor generator

A device used for operating auxiliary equipment, such as pumps, blowers, exciters, rotating magnetic amplifiers, etc.

3.1.89 Device number 89—line switch

A device used as a disconnecting, load-interrupter, or isolating switch in an ac or dc power circuit. (This device function number is normally not necessary unless the switch is electrically operated or has electrical accessories, such as an auxiliary switch, a magnetic lock, etc.)

3.1.90 Device number 90—regulating device

A device that functions to regulate a quantity or quantities, such as voltage, current, power, speed, frequency, temperature, and load, at a certain value or between certain (generally close) limits for machines, tie lines, or other apparatus.

3.1.91 Device number 91—voltage directional relay

A device that operates when the voltage across an open circuit breaker or contactor exceeds a given value in a given direction.

3.1.92 Device number 92—voltage and power directional relay

A device that permits or causes the connection of two circuits when the voltage difference between them exceeds a given value in a predetermined direction and causes these two circuits to be disconnected from each other when the power flowing between them exceeds a given value in the opposite direction.

3.1.93 Device number 93—field-changing contactor

A device that functions to increase or decrease, in one step, the value of field excitation on a machine.

3.1.94 Device number 94—tripping or trip-free relay

A device that functions to trip a circuit breaker, contactor, or equipment; to permit immediate tripping by other devices; or to prevent immediate reclosing of a circuit interrupter if it should open automatically, even though its closing circuit is maintained closed.

3.1.95 Device numbers 95–99—used only for specific applications

These device numbers are used in individual specific installations if none of the functions assigned to the numbers from 1 through 94 are suitable.

FIGURE 1.10 (Continued)

IEEE Std C37.2-1996

IEEE STANDARD ELECTRICAL POWER SYSTEM DEVICE

3.2 Addition of prefixes and suffixes

Letters and numbers may be used as prefixes or suffixes to device function numbers to provide a more specific definition of the function, as discussed below. They permit a manifold multiplication of available function designations for the large number and variety of devices used in the many types of equipment covered by this standard. They may also serve to denote individual or specific parts or auxiliary contacts of these devices or certain distinguishing features, characteristics, or conditions that describe the use of the device or its contacts in the equipment.

Prefixes and suffixes should, however, be used only when they accomplish a useful purpose. For example, when all of the devices in a piece of equipment are associated with only one kind of apparatus, such as a feeder, motor, or generator, it is common practice, in order to retain maximum simplicity in device function identification, not to add the respective suffix letters F, M, or G to any of the device function numbers.

In order to prevent any possible conflict or confusion, each letter suffix should preferably have only one meaning in individual pieces of equipment. To accomplish this, short, distinctive abbreviations, such as those contained in ASME Y1.1-1989, or any appropriate combination of letters may also be used as letter suffixes where necessary. However, each suffix should not consist of more than three (and preferably not more than two) letters, in order to keep the complete function designation as short and simple as possible. The meaning of each suffix should be designated on the drawings or in the publications with which they are used, similar to TC-trip coil, V-voltage, X-auxiliary relay.

In cases where the same suffix (consisting of one letter or a combination of letters) has different meanings in the same equipment depending upon the device function number with which it is used, then the complete device function number with its suffix letter or letters and its corresponding function definition should be listed in the legend in each case, i.e., 63V-vacuum relay, 70R-raising relay for device 70, 90V-voltage regulator.

3.3 Suggested prefixes

A similar series of numbers, prefixed by the letters RE (for *remote*) may be used for the interposing relays performing functions that are controlled directly from the supervisory system. Typical examples of such functions are RE1, RE5, and RE94.

In multiple-unit installations, it may be desirable to use a prefix number to distinguish between device functions associated with individual units. For example, in pipeline pump stations, the numbers 1–99 are applied to device functions that are associated with the overall station operation. A similar series of numbers, starting with 101 instead of 1, are used for those device functions that are associated with unit 1; a similar series starting with 201 for device functions that are associated with unit 2; and so on, for each unit in these installations.

3.4 Suggested suffix letters

Subclauses 3.4.1 through 3.4.6 describe letters that are commonly used and are recommended for use when required and as appropriate.

3.4.1 Auxiliary devices

These letters denote separate auxiliary devices, such as the following:

C	Closing relay/contacter
CL	Auxiliary relay, closed (energized when main device is in closed position)
CS	Control switch
D	“Down” position switch relay
L	Lowering relay
O	Opening relay/contacter

FIGURE 1.10 (Continued)

FUNCTION NUMBERS AND CONTACT DESIGNATIONS

IEEE Std C37.2-1996

OP	Auxiliary relay, open (energized when main device is in open position)
PB	Push button
R	Raising relay
U	“UP” position switch relay
X	Auxiliary relay
Y	Auxiliary relay
Z	Auxiliary relay

NOTE — In the control of a circuit breaker with a so-called X-Y relay control scheme, the X relay is the device whose main contacts are used to energize the closing coil or the device that in some other manner, such as by the release of stored energy, causes the breaker to close. The contacts of the Y relay provide the antipump feature of the circuit breaker.

3.4.2 Actuating quantities

These letters indicate the condition or electrical quantity to which the device responds, or the medium in which it is located, such as the following:

A	Air/amperes/alternating
C	Current
D	Direct/discharge
E	Electrolyte
F	Frequency/flow/fault
GP	Gas pressure
H	Explosive/harmonics
I0	Zero sequence current
I-, I2	Negative sequence current
I+, I1	Positive sequence current
J	Differential
L	Level/liquid
P	Power/pressure
PF	Power factor
Q	Oil
S	Speed/suction/smoke
T	Temperature
V	Voltage/volts/vacuum
VAR	Reactive power
VB	Vibration
W	Water/watts

3.4.3 Main device

The following letters denote the main device to which the numbered device is applied or is related:

A	Alarm/auxiliary power
AC	Alternating current
AN	Anode
B	Battery/blower/bus
BK	Brake
BL	Block (valve)
BP	Bypass
BT	Bus tie
C	Capacitor/condenser/compensator/carrier current/case/compressor
CA	Cathode
CH	Check (valve)
D	Discharge (valve)
DC	Direct current
E	Exciter
F	Feeder/field/filament/filter/fan

48 Electrical Engineer's Portable Handbook

FIGURE 1.10 (Continued)

IEEE Std C37.2-1996

IEEE STANDARD ELECTRICAL POWER SYSTEM DEVICE

G	Generator/ground ³
H	Heater/housing
L	Line/logic
M	Motor/metering
MOC	Mechanism operated contact ⁴
N	Network/neutral ⁵
P	Pump/phase comparison
R	Reactor/rectifier/room
S	Synchronizing/secondary/strainer/sump/suction (valve)
T	Transformer/thyatron
TH	Transformer (high-voltage side)
TL	Transformer (low-voltage side)
TM	Telemeter
TOC	Truck-operated contacts ⁶
TT	Transformer (tertiary-voltage side)
U	Unit

3.4.4 Main device parts

These letters denote parts of the main device, except auxiliary contacts, position switches, limit switches, and torque limit switches, which are covered in Clause 4.

BK	Brake
C	Coil/condenser/capacitor
CC	Closing coil/closing contactor
HC	Holding coil
M	Operating motor
MF	Fly-ball motor
ML	Load-limit motor
MS	Speed adjusting or synchronizing motor
OC	Opening contactor
S	Solenoid
SI	Seal-in
T	Target
TC	Trip coil
V	Valve

3.4.5 Other suffix letters

The following letters cover all other distinguishing features, characteristics, or conditions not specifically described in 3.4.1 through 3.4.4, which serve to describe the use of the device in the equipment, such as

A	Accelerating/automatic
B	Blocking/backup
BF	Breaker failure
C	Close/cold
D	Decelerating/detonate/down/disengaged
E	Emergency/engaged
F	Failure/forward
GP	General purpose
H	Hot/high

³Suffix N is preferred when the device is connected in the residual of a polyphase circuit, is connected across a broken delta, or is internally derived from the polyphase current or voltage quantities. The suffix G is preferred where the measured quantity is in the path to ground or, in the case of ground fault detectors, is the current flowing to ground. See A.2 in Annex A for examples.

⁴MOC denotes a circuit breaker mechanism-operated auxiliary switch that is mounted on the stationary housing of a removable circuit breaker.

⁵See Footnote 3.

⁶TOC denotes a circuit breaker truck-operated auxiliary switch that is mounted on the stationary housing of a removable circuit breaker.

FIGURE 1.10 (Continued)

FUNCTION NUMBERS AND CONTACT DESIGNATIONS

IEEE Std C37.2-1996

HIZ	High impedance fault
HR	Hand reset
HS	High speed
L	Left/local/low/lower/leading
M	Manual
O	Open/over
OFF	Off
ON	On
P	Polarizing
R	Right/raise/reclosing/receiving/remote/reverse
S	Sending/swing
SHS	Semi-high speed
T	Test/trip/trailing
TDC	Time-delay closing contact
TDDO	Time delayed relay coil drop-out
TDO	Time-delay opening contact
TDPU	Time delayed relay coil pickup
THD	Total harmonic distortion
U	Up/under

3.4.6 Use of suffix letters

Lowercase (small) letters are used in practically all instances on electrical diagrams for the auxiliary, position, and limit switches, as shown in 4.1. Uppercase (capital) letters are generally used for all suffix letters in 3.4.

The letters in 3.4.1 through 3.4.3, since they should generally form part of the device function designation, are usually written directly after the device function number, for example, 52CS, 71W, or 49D. When it is necessary to use two types of suffix letters in connection with one function number, it is often desirable for clarity to separate them by a slanted line or dash, as, for example, 20D/CS or 20D-CS.

The suffix letters in 3.4.4, which denote parts of the main device, and those in 3.4.5, which cannot or need not form part of the device function designation, are generally written directly below the device function number on the drawings, for example

52/CC or 43/A (see Figure 4)

3.5 Suffix numbers

If two or more devices with the same function number and suffix letter (if used) are present in the same piece of equipment, they may be distinguished by numbered suffixes, as, for example, 4X-1, 4X-2, and 4X-3, when necessary.

3.6 Devices performing more than one function

If one device performs two important functions in a piece of equipment so that it is desirable to identify both of these functions, a double function number and name, such as 50/51 instantaneous and time overcurrent relay may be used.

4. Device contacts

4.1 Auxiliary, position, and limit switch contacts

The letters *a* and *b* shall be used for all auxiliary, position, and limit switch contacts for such devices and equipment as circuit breakers, contactors, valves and rheostats, and contacts of relays as follows:

- a* Contact that is open when the main device is in the standard reference position, commonly referred to as the nonoperated or de-energized position, and that closes when the device assumes the opposite position

50 Electrical Engineer's Portable Handbook

FIGURE 1.10 (Continued)

IEEE Std C37.2-1996

IEEE STANDARD ELECTRICAL POWER SYSTEM DEVICE

- b* Contact that is closed when the main device is in the standard reference position, commonly referred to as the nonoperated or de-energized position, and that opens when the device assumes the opposite position

The simple designation *a* or *b* is used in all cases where there is no need to adjust the contacts to change position at any particular point in the travel of the main device or where the part of the travel where the contacts change position is of no significance in the control or operating scheme. Hence, the *a* and *b* designations usually are sufficient for circuit breaker auxiliary switches.

Standard reference positions of some typical devices are given in Table 1.

Table 1— Standard reference positions of devices

Device	Standard reference position
Adjusting means (see note 1)	Low or down position
Clutch	Disengaged position
Contactors (see note 2)	De-energized position
Contactors (latched-in type)	Main contacts open
Density switch	Standard reference
Disconnecting switch	Main contacts open
Flow detector (see note 3)	Lowest flow
Gate	Closed position
Level detector (see note 3)	Lowest level
Load-break switch	Main contacts open
Power circuit breaker	Main contacts open
Power electrodes	Maximum gap position
Pressure switch (see note 3)	Lowest pressure
Reclosure	Main contactor open
Relay (see note 2)	De-energized position
Relay (latched-in type)	See 4.5.3
Rheostat	Maximum resistance position
Speed switch (see note 3)	Lowest speed
Tap changer	Center tap
Temperature relay (see note 3)	Lowest temperature
Turning gear	Disengaged position
Vacuum switch (see note 3)	Lowest pressure that is highest vacuum
Valve	Closed position
Vibration detector (see note 3)	Minimum vibration
NOTES:	
1)—These may be speed, voltage, current, load, or similar adjusting devices comprising rheostats, springs, levers, or other components for the purpose.	
2)—These electrically operated devices are of the nonlatched-in type, whose contact position is dependent only upon the degree of energization of the operating, restraining, or holding coil or coils that may or may not be suitable for continuous energization. The de-energized position of the device is that with all coils de-energized	
3)—The energizing influences for these devices are considered to be, respectively, rising temperature, rising level, increasing flow, rising speed, increasing vibration, and increasing pressure.	

4.1.1 Auxiliary switches with defined operating position

When it is desired to have the auxiliary, position, or limit switch designation, it should be indicated at what point of travel the contacts change position, as is sometimes necessary in the case of valves and for other main devices. Then an additional letter (or a percentage figure, if required) is added (as a suffix to the *a* or *b* designation) for this purpose.

FIGURE 1.10 (Continued)

FUNCTION NUMBERS AND CONTACT DESIGNATIONS

IEEE Std C37.2-1996

For a valve, the method of designating such position switches is shown in the diagram and legend in Figure 1. There are thus two points to consider in visualizing or describing the operation of these position switches. The first is whether the contact is *a* or *b* as indicated by the first letter. The second is where the contact changes position, either at or near:

- a) The closed position of the valve *c*,
- b) The open position of the valve *o*, or
- c) A specified percentage such as 25% of the full open position, for example, a25.

When applied to devices other than valves, gates, circuit breakers, and switches for which the letters *o* and *c* are used for *open* and *closed*, respectively, it will be necessary to use other applicable letters. For example, for such devices as a clutch, turning gear, rheostat, electrode, and adjusting device, the letters *d*, *e*, *h*, *l*, *u*, and *d*, meaning *disengaged*, *engaged*, *high*, *low*, *up*, and *down*, respectively, are applicable. Also, other appropriate suffix letters may be used for special *a* or *b* position switches, when these are considered more appropriate and if their meaning is clearly indicated. For example, in the case of an early-opening auxiliary switch on a power circuit breaker, adjusted to open when the breaker is tripped before the main contacts part, it may be thus described and then designated as an *ae* auxiliary switch.

Example:

20BL/ac

designates an auxiliary switch, on a block valve, that is open only when the valve is fully closed

20D/a10

designates an auxiliary switch, on a discharge valve, that is open except when the valve is 10% or more open

FIGURE 1.10 (Continued)

IEEE Std C37.2-1996

IEEE STANDARD ELECTRICAL POWER SYSTEM DEVICE

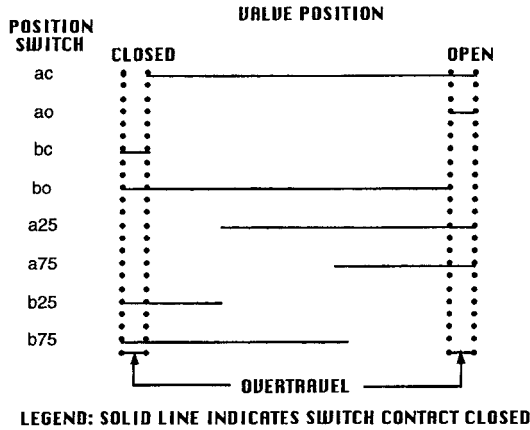

Each of the eight valve positions can be described as follows:

- ac, a contact that changes position at or near the closed position of the valve, that is, open only when the valve is fully closed
- ao, a contact that changes position at or near the open position of the valve, that is, closed only when the valve is fully open
- bc, b contact that changes position at or near the closed position of the valve, that is, closed only when the valve is fully closed
- bo, b contact that changes position at or near the open position of the valve, that is, open only when the valve is fully open
- a25, a contact that changes position when the valve is 25% open, that is, closed only when the valve is open 25% or more
- a75, a contact that changes position when the valve is 75% open, that is, closed only when the valve is open 75% or more
- b25, b contact that changes position when the valve is 25% open, that is, closed only when the valve is open less than 25%
- b75, b contact that changes position when the valve is 75% open, that is, closed only when the valve is open less than 75%

Figure 1— Valve

4.1.2 Auxiliary switches for devices without a standard reference position

In designating position switches for such a special device as, for example, a fuel transfer device, which has no standard reference or nonoperated position and may be placed in either extreme or any intermediate position for normal operation, *a* and *b* designations are still applicable. However, a percentage figure of the “full open” or “on” position should always be used, and, for the sake of consistency, this percentage should always be in terms of the position that is 50% or more of the “full open” or “on” position, as shown in Figure 2.

FIGURE 1.10 (Continued)

FUNCTION NUMBERS AND CONTACT DESIGNATIONS

IEEE Std C37.2-1996

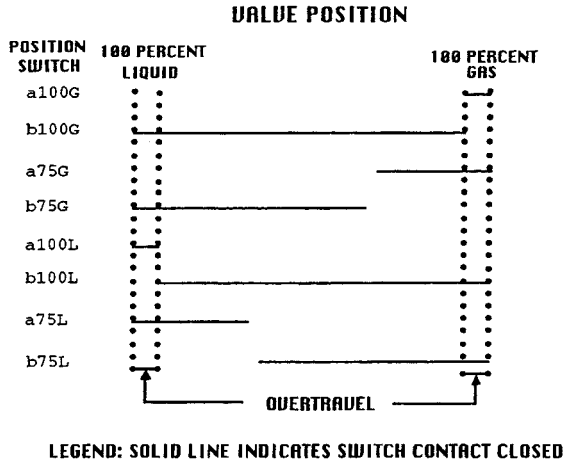

Each of the eight positions can be described as follows:

- a100G closed only when 100% of the fuel being supplied is gas
- b100G closed only when less than 100% of the fuel being supplied is gas
- a75G closed only when 75% or more of the fuel being supplied is gas
- b75G closed only when less than 75% of the fuel being supplied is gas
- a100L closed only when 100% of the fuel being supplied is liquid
- b100L closed only when less than 100% of the fuel being supplied is liquid
- a75L closed only when 75% or more of the fuel being supplied is liquid
- b75L closed only when less than 75% of the fuel being supplied is liquid

Figure 2— Fuel transfer device

4.2 Limit switches

LS designates a limit switch. This is a position switch that is actuated by a main device, such as a rheostat or valve, at or near its extreme end of travel. Its usual function is to open the circuit of the operating device, but it may also serve to give an indication that the main device has reached an extreme position of travel. The designations *ac*, *ao*, *bc*, and *bo*, given in Figure 1, are actually more descriptive for valve limit switches than such designations as LSC or LSO. Also, in the case of a fuel transfer device as covered in 4.1.2, designations such as a100G, b100G, a100L, and b100L are more descriptive than LS designations. In both cases they indicate whether the specific contact is an *a* contact or a *b* contact.

54 Electrical Engineer's Portable Handbook

FIGURE 1.10 (Continued)

4.2.1 Auxiliary switches for circuit breaker operating mechanisms

For the mechanically trip-free mechanism of a circuit breaker:

- aa* Contact that is open when the operating mechanism of the main device is in the nonoperated position and that closes when the operating mechanism assumes the opposite position
- bb* Contact that is closed when the operating mechanism of the main device is in the nonoperated position and that opens when the operating mechanism assumes the opposite position

The part of the stroke at which the auxiliary switch changes position should, if necessary, be specified in the description. LC is used to designate the latch-checking switch of such a mechanism, which is closed when the mechanism linkage is relatched after an opening operation of the circuit breaker.

4.3 Torque limit switches

This is a switch that is used to open an operating motor circuit at a desired torque limit at the extreme end of travel of a main device, such as a valve. It should be designated as follows:

- tqc* Torque limit switch, opened by a torque-responsive mechanism, that stops valve closing
- tqo* Torque limit switch, opened by a torque-responsive mechanism, that stops valve opening

4.4 Other switches

If several similar auxiliary, position, and limit switches are present on the same device, they should be designated with such supplementary numerical suffixes as 1, 2, 3, etc., when necessary.

4.5 Representation of device contacts on electrical diagrams

4.5.1 Contacts with defined reference position

On electrical diagrams, the *b* contacts of all devices as described in 4.1 to 4.1.3, including those of relays and those with suffix letters or percentage figures, should be shown as closed contacts, and all *a* contacts should be shown as open contacts. The use of the single letters *a* and *b* with the contact representation is generally superfluous on the diagrams. However, these letters are a convenient means of reference in the text of instruction books, articles, and other publications (see Figure 3, Figure 4, and IEEE Std 315-1975 for representation of closed and open contacts on electrical diagrams).

4.5.2 Contact opening and closing settings

The opening and closing settings of the contacts and auxiliary, position, and limit switches, covered in 4.1 through 4.3 should, when necessary for the ready understanding of the operation of the devices in the equipment, be indicated on the elementary diagram for each such contact. In the case of relay contacts, this indication would consist of the numerical settings; in the case of the switches, this indication would consist of a chart similar to those shown in Figures 1 and 2, respectively.

4.5.3 Devices without a standard reference position

For those devices that have no de-energized or nonoperated position, such as manually-operated transfer or control switches (including those of the spring-return type) or auxiliary position indicating contacts on the housings or enclosures of a removable circuit breaker unit, the preferred method of representing these contacts is normally open. Each contact should, however, be identified on the elementary diagram as to when it closes.⁷ For example, the contacts of the manual-automatic transfer switch, device 43, which are closed in the automatic position, would be identified

FIGURE 1.10 (Continued)

FUNCTION NUMBERS AND CONTACT DESIGNATIONS

IEEE Std C37.2-1996

with the letter A, and those that are closed in the manual position would be identified with the letter M; and the auxiliary position switches on the housing 52 TOC of a removable circuit breaker unit, which are open when the unit is not in the connected position, may be identified by

52TOC/a

and those that are closed when the unit is not in the connected position may be identified by

52TOC/b

as shown in IEEE Std C37.20.1-1993 and IEEE Std C37.20.2-1993 .

In the case of latched-in or hand-reset relays, which operate from protective devices to perform the shutdown of a piece of equipment and hold it out of service, the contacts should preferably be shown in the normal, nonlockout position. In general, any devices, such as electrically operated latched-in relays, that have no de-energized or nonoperated position and have not been specifically covered in the above paragraphs or under 4.1, should have their contacts shown in the position most suitable for the proper understanding of the operation of the devices in the equipment. Sufficient description should be present, as necessary, on the elementary diagram to indicate the contact operation.⁸

4.5.4 Recommended representation of device functions and contacts on drawings

The typical elementary diagrams in Figures 3 and 4 illustrate the recommended method of representing the contacts of typical devices on an elementary diagram. All other representations and features, except those specifically covered in other standards, are illustrative only and are not necessarily generally accepted practice.

⁷This information should be included on that part of the elementary diagram either with the device symbol or with the contacts in the circuit diagram itself, and where most convenient for the proper understanding of the operation of the devices and equipment.

⁸See Footnote 7.

56 Electrical Engineer's Portable Handbook

FIGURE 1.10 (Continued)

IEEE Std C37.2-1996

IEEE STANDARD ELECTRICAL POWER SYSTEM DEV

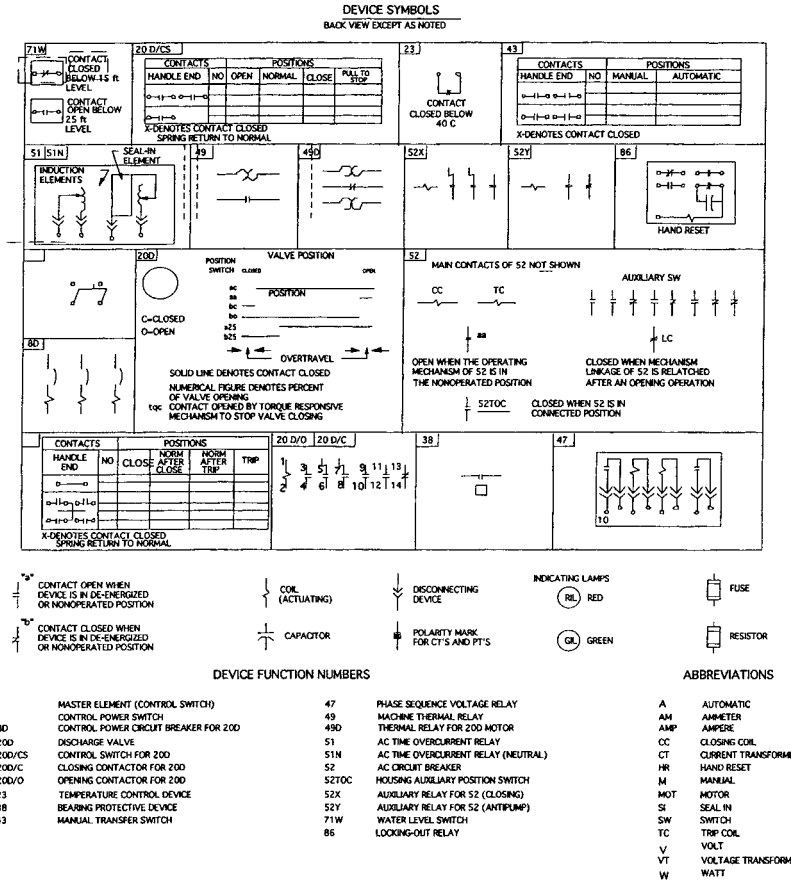

Figure 3— Typical elementary diagram

FIGURE 1.10 (Continued)

FUNCTION NUMBERS AND CONTACT DESIGNATIONS

IEEE Std C37.

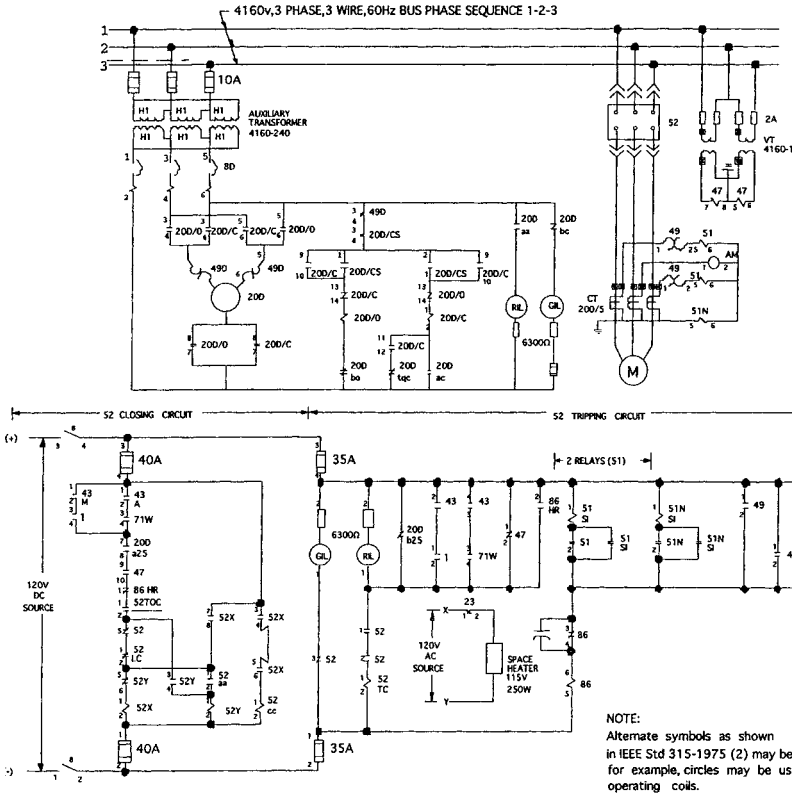

Figure 4— Typical elementary diagram

1.5 NEMA STANDARD ENCLOSURES

Indoor Nonhazardous Locations (Table 1.2)

Outdoor Nonhazardous Locations (Table 1.3)

Indoor Hazardous Locations (Table 1.4)

Knockout Dimensions (Table 1.5)

TABLE 1.2 Comparison of Specific Applications of Enclosures for Indoor Nonhazardous Locations

Provides a Degree of Protection Against the Following Environmental Conditions	Type of Enclosures									
	1 ^①	2 ^①	4	4X	5	6	6P	12	12K	13
Incidental contact with the enclosed equipment	X	X	X	X	X	X	X	X	X	X
Falling dirt	X	X	X	X	X	X	X	X	X	X
Falling liquids and light splashing	...	X	X	X	X	X	X	X	X	X
Circulating dust, lint, fibers, and flyings ^②	X	X	...	X	X	X	X	X
Settling airborne dust, lint, fibers, and flyings ^②	X	X	X	X	X	X	X	X
Hosedown and splashing water	X	X	...	X	X
Oil and coolant seepage	X	X	X
Oil or coolant spraying and splashing	X
Corrosive agents	X	X
Occasional temporary submersion	X	X
Occasional prolonged submersion	X

TABLE 1.3 Comparison of Specific Applications of Enclosures for Outdoor Nonhazardous Locations

Provides a Degree of Protection Against the Following Environmental Conditions	Type of Enclosures						
	3	3R ^③	3S	4	4X	6	6P
Incidental contact with the enclosed equipment	X	X	X	X	X	X	X
Rain, snow, and sleet ^④	X	X	X	X	X	X	X
Sleet ^⑤	X
Windblown dust	X	...	X	X	X	X	X
Hosedown	X	X	X	X
Corrosive agents	X	...	X
Occasional temporary submersion	X	X
Occasional prolonged submersion	X

① These enclosures may be ventilated. However, Type 1 may not provide protection against small particles of falling dirt when ventilation is provided in the enclosure top. Consult the manufacturer.

② These fibers and flying are nonhazardous materials and are not considered the Class III type ignitable fibers or combustible flyings. For Class III

type ignitable fibers or combustible flyings see the National Electrical Code, Article 500.

③ External operating mechanisms are not required to be operable when the enclosure is ice covered.

④ External operating mechanisms are operable when the enclosure is ice covered.

⑤ These enclosures may be ventilated.

TABLE 1.4 Comparison of Specific Applications for Indoor Hazardous Locations

Provides a Degree of Protection Against Atmospheres Typically Containing (For Complete Listing, See NFPA 497M-1986, <i>Classification of Gases, Vapors and Dusts for Electrical Equipment in Hazardous (Classified) Locations</i>)	Class	Type of Enclosure 7 and 8, Class I Groups®				Type of Enclosure 9, Class II Groups®			
		A	B	C	D	E	F	G	10
Acetylene	I	X
Hydrogen, manufactured gas	I	...	X
Diethyl ether, ethylene, cyclopropane	I	X
Gasoline, hexane, butane, naphtha, propane, acetone, toluene, isoprene	I	X
Metal dust	II	X
Carbon black, coal dust, coke dust	II	X
Flour, starch, grain dust	II	X	...
Fibers, flyings [Ⓣ]	III	X	...
Methane with or without coal dust	MSHA	X

TABLE 1.5 Knockout Dimensions

Conduit Trade Size, inches	Knockout Diameter, Inches		
	Minimum	Nominal	Maximum
1/2	0.859	0.875	0.906
3/4	1.094	1.109	1.141
1	1.359	1.375	1.406
1 1/4	1.719	1.734	1.766
1 1/2	1.958	1.984	2.016
2	2.433	2.469	2.500
2 1/2	2.938	2.969	3.000
3	3.563	3.594	3.625
3 1/2	4.063	4.125	4.156
4	4.563	4.641	4.672
5	5.625	5.719	5.750
6	6.700	6.813	6.844

® For Class III type ignitable fibers or combustible flyings see the National Electrical Code, Article 500.

Ⓣ Due to the characteristics of the gas, vapor, or dust, a product suitable for one Class or Group may not be suitable for another Class or Group unless so marked on the product.

1.6 FORMULAS AND TERMS

FIGURE 1.11 Formulas and terms.

Formulas for Determining Amperes, hp, kW, and kVA

To Find	Direct Current		Alternating Current		
			Single-Phase	Two-Phase — 4 Wires ¹	Three-Phase
Amperes (I) When Horsepower is Known	$\frac{hp \times 746}{E \times \% \text{ eff}}$		$\frac{hp \times 746}{E \times \% \text{ eff} \times pf}$	$\frac{hp \times 746}{2 \times E \times \% \text{ eff} \times pf}$	$\frac{hp \times 746}{\sqrt{3} \times E \times \% \text{ eff} \times pf}$
Amperes (I) When Kilowatts is Known	$\frac{kW \times 1000}{E}$		$\frac{kW \times 1000}{E \times pf}$	$\frac{kW \times 1000}{2 \times E \times pf}$	$\frac{kW \times 1000}{\sqrt{3} \times E \times pf}$
Amperes (I) When kVA is Known			$\frac{kVA \times 1000}{E}$	$\frac{kVA \times 1000}{2 \times E}$	$\frac{kVA \times 1000}{\sqrt{3} \times E}$
Kilowatts	$\frac{I \times E}{1000}$		$\frac{I \times E \times pf}{1000}$	$\frac{I \times E \times 2 \times pf}{1000}$	$\frac{I \times E \times \sqrt{3} \times pf}{1000}$
kVA			$\frac{I \times E}{1000}$	$\frac{I \times E \times 2}{1000}$	$\frac{I \times E \times \sqrt{3}}{1000}$
Horsepower (Output)	$\frac{I \times E \times \% \text{ eff}}{746}$		$\frac{I \times E \times \% \text{ eff} \times pf}{746}$	$\frac{I \times E \times 2 \times \% \text{ eff} \times pf}{746}$	$\frac{I \times E \times \sqrt{3} \times \% \text{ eff} \times pf}{746}$

Common Electrical Terms

Ampere (I) = unit of current or rate of flow of electricity

Volt (E) = unit of electromotive force

Ohm (R) = unit of resistance
Ohms law: $I = \frac{E}{R}$ (DC or 100% pf)

Megohm = 1,000,000 ohms

Volt Amperes (VA) = unit of apparent power
= $E \times I$ (single-phase)
= $E \times I \times \sqrt{3}$

Kilovolt Amperes (kVA) = 1000 volt-amperes

Watt (W) = unit of true power
= $VA \times pf$
= .00134 hp

Kilowatt (kW) = 1000 watts

Power Factor (pf) = ratio of true to apparent power
 $\frac{W}{VA} = \frac{kW}{kVA}$

Watt-hour (Wh) = unit of electrical work
= one watt for one hour
= 3,413 Btu
= 2,685 ft. lbs.

Kilowatt-hour (kWh) = 1000 watt-hours

Horsepower (hp) = measure of time rate of doing work
= equivalent of raising 33,000 lbs. one ft. in one minute
= 746 watts

Demand Factor = ratio of maximum demand to the total connected load

Diversity Factor = ratio of the sum of individual maximum demands of the various subdivisions of a system to the maximum demand of the whole system

Load Factor = ratio of the average load over a designated period of time to the peak load occurring in that period

How to Compute Power Factor

Determining watts: $pf = \frac{\text{watts}}{\text{volts} \times \text{amperes}}$

- From watt-hour meter.
Watts = rpm of disc $\times 60 \times Kh$
Where Kh is meter constant printed on face or nameplate of meter.
If metering transformers are used, above must be multiplied by the transformer ratios.
- Directly from wattmeter reading.
Where:
Volts = line-to-line voltage as measured by voltmeter.
Amps = current measured in line wire (not neutral) by ammeter.

Temperature Conversion

	C ^o =5/9 (F ^o -32 ^o)				F ^o =9/5(C ^o)+32 ^o			
	[F ^o to C ^o]				[C ^o to F ^o]			
C ^o	15	10	5	0	5	10	15	20
F ^o	5	14	23	32	41	50	59	68
C ^o	25	30	35	40	45	50	55	60
F ^o	77	86	95	104	113	122	131	140
C ^o	65	70	75	80	85	90	95	100
F ^o	149	158	167	176	185	194	203	212

1 inch	= 2.54 centimeters
1 kilogram	= 2.20 lbs.
1 square inch	= 1,273,200 circular mils
1 circular mill	= .785 square mil
1 Btu	= 778 ft. lbs. = 252 calories
1 year	= 8,760 hours

¹ For 2-phase, 3-wire circuits the current in the common conductor is $\sqrt{2}$ times that in either of the two other conductors.

1.7 TYPICAL EQUIPMENT SIZES AND WEIGHTS

Tables 1.6 to 1.11 provide typical equipment sizes and weights to assist in the preliminary design and layout of an electrical distribution system. The reader is cautioned that this data is only representative of industry manufacturers and should consult specific vendors for detailed information. This information could prove useful in determining initial space requirements and weight impacts for structural purposes.

1.8 SEISMIC REQUIREMENTS

The design of seismic restraint systems for electrical distribution equipment and raceways is usually done by a structural engineer through performance specifications by the electrical design professional. It is therefore necessary for the electrical designer to be generally familiar with the seismic code requirements and the seismic zone that are applicable to a project. Figure 1.12 will serve as an introduction.

TABLE 1.6 Typical Equipment Sizes—600-Volt Class

Equipment	KVA Rating	Dimensions (inches)			Weight Lbs. (CU)	Weight Lbs. (AL)
		H	W	D		
Switchboards (per Section)	N/A	90	26 - 45	24 - 60	Varies	Varies
Motor Control Centers (per Section)	N/A	90	20	16 - 22	Varies	Varies
Power Panel	N/A	To 80	30 - 48	6 - 12	Varies	Varies
Lighting/Small Appliance Panels	N/A	30 - 50	22	6	Varies	Varies
Transformers 3-phase, Dry Type, General Purpose	30	30	20	15	300	230
	45	30	20	15	370	310
	75	40	26	20	550	480
	112.5	40	26	20	675	600
	150	46	26	21	850	760
	300	56	32	24	1750	1300
Transformers 3-phase, Dry Type, K-Rated	500	75	45	36	3100	2400
	30	31	21	15	370	310
	45	40	26	20	575	480
	75	40	26	20	675	600
	112.5	56	31	24	850	760
	150	56	31	24	1200	760
300	75	45	36	3100	1100	
500	90	69	42	see mfg.	2400	
						4500

TABLE 1.7 Transformer Weight (lbs) by KVA

Oil Filled 3 Phase 5/15 KV To 480/277			
KVA	Lbs.	KVA	Lbs.
150	1800	1000	6200
300	2900	1500	8400
500	4700	2000	9700
750	5300	3000	15000
Dry 240/480 To 120/240 Volt			
1 Phase		3 Phase	
KVA	Lbs.	KVA	Lbs.
1	23	3	90
2	36	6	135
3	59	9	170
5	73	15	220
7.5	131	30	310
10	149	45	400
15	205	75	600
25	255	112.5	950
37.5	295	150	1140
50	340	225	1575
75	550	300	1870
100	670	500	2850
167	900	750	4300

TABLE 1.8 Generator Weight (lbs) by KW

3 Phase 4 Wire 277/480 Volt			
Gas		Diesel	
KW	Lbs.	KW	Lbs.
7.5	600	30	1800
10	630	50	2230
15	960	75	2250
30	1500	100	3840
65	2350	125	4030
85	2570	150	5500
115	4310	175	5650
170	6530	200	5930
		250	6320
		300	7840
		350	8220
		400	10750
		500	11900

TABLE 1.9 Weight (lbs/lf) of Four-Pole Aluminum and Copper Bus Duct by Ampere Load

Amperes	Aluminum Feeder	Copper Feeder	Aluminum Plug-In	Copper Plug-In
225			7	7
400			8	13
600	10	10	11	14
800	10	19	13	18
1000	11	19	16	22
1350	14	24	20	30
1600	17	26	25	39
2000	19	30	29	46
2500	27	43	36	56
3000	30	48	42	73
4000	39	67		
5000		78		

TABLE 1.10 Conduit Weight Comparisons (lbs per 100 ft) Empty

Type	1/2"	3/4"	1"	1-1/4"	1-1/2"	2"	2-1/2"	3"	3-1/2"	4"	5"	6"
Rigid Aluminum	28	37	55	72	89	119	188	246	296	350	479	630
Rigid Steel	79	105	153	201	249	332	527	683	831	972	1314	1745
Intermediate Steel (IMC)	60	82	116	150	182	242	401	493	573	638		
Electrical Metallic Tubing (EMT)	29	45	65	96	111	141	215	260	365	390		
Polyvinyl Chloride, Schedule 40	16	22	32	43	52	69	109	142	170	202	271	350
Polyvinyl Chloride Encased Bural						38		67	88	105	149	202
Fibre Duct Encased Bural						127		164	180	206	400	511
Fibre Duct Direct Bural						150		251	300	354		
Transite Encased Bural						160		240	290	330	450	550
Transite Direct Bural						220		310	400	400	540	640

TABLE 1.11 Conduit Weight Comparisons (lbs per 100 ft) with Maximum Cable Fill

Type	1/2"	3/4"	1"	1-1/4"	1-1/2"	2"	2-1/2"	3"	3-1/2"	4"	5"	6"
Rigid Galvanized Steel (RGS)	104	140	235	358	455	721	1022	1451	1749	2148	3083	4343
Intermediate Steel (IMC)	84	113	186	293	379	611	883	1263	1501	1830		
Electrical Metallic Tubing (EMT)	54	116	183	296	368	445	641	930	1215	1540		

*Conduit & Heaviest Conductor Combination

FIGURE 1.12 Seismic requirements. (a) Seismic zone map of the United States. (b) Normalized response spectra shapes.

Seismic Requirements

Uniform Building Code (UBC)

The 1994 Uniform Building Code (UBC) includes Volume 2 for earthquake design requirements. Sections 1624-1633 of this reference specifically require that structures and portions of structures shall be designed to withstand the seismic ground motion specified in the code. The design engineer must evaluate the effect of lateral forces not only on the building structure but also on the equipment in determining whether the design will withstand those forces. In the code electrical equipment such as control panels, motors, switchgear, transformers, and associated conduit are specifically identified.

The criteria for selecting the seismic requirements are defined in Section 1627 of the code. Panel a of the code includes a seismic zone map of the United States. Panel b of the code includes the normalized response spectra shapes for different soil conditions. The damping value is 5% of the critical damping.

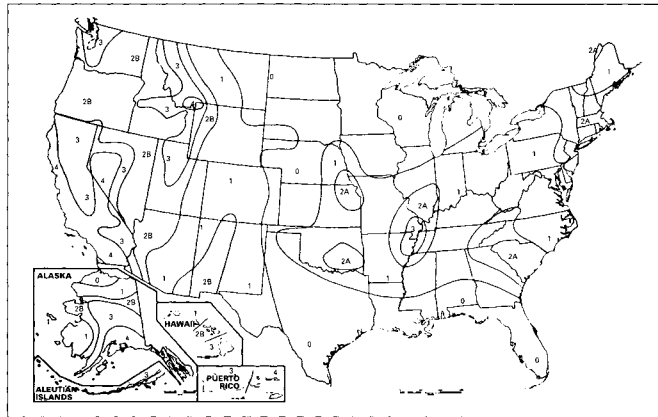

(a)

FIGURE 1.11 Seismic requirements. (a) Seismic zone map of the United States. (b) Normalized response spectra shapes. (Continued)

The seismic requirements in the UBC can be completely defined as the Zero Period Acceleration (ZPA) and Spectrum Accelerations are computed. In a test program, these values are computed conservatively to envelop the requirements of all seismic zones. The lateral force on elements of structures and nonstructural components are defined in Section 1630. The dynamic lateral forces are defined in Section 1629. These loads are converted to seismic accelerations according to the normalized response spectra shown in Panel b of the UBC.

The total design lateral force required is:

$$\text{Force } F_p = Z I_p C_p W_p$$

Dividing both sides by W_p , the acceleration requirement in g's is equal to:

$$\text{Acceleration} = F_p/W_p = Z I_p C_p$$

Where:

- Z:** is the seismic zone factor and is taken equal to 0.4. This is the maximum value provided in Table 16-I of the code.
- I_p :** is the importance factor and is taken equal to 1.5. This is the maximum value provided in Table 16-K of the code.
- C_p :** is the horizontal force factor and is taken equal to 0.75 for rigid equipment as defined in Table 16-O. For flexible equipment, this value is equal to twice the value for the rigid equipment: $2 \times 0.75 = 1.5$. This is the maximum value provided in the code.
- W_p :** is the weight of the equipment.

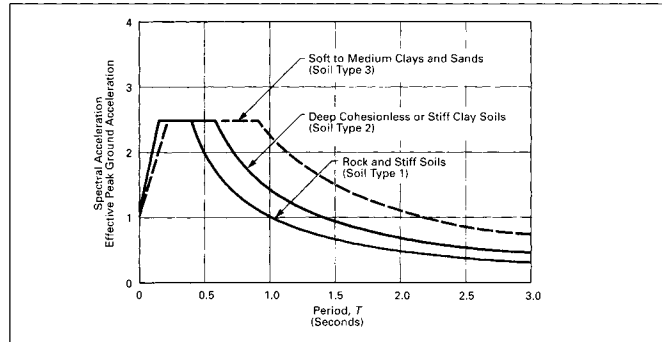

(b)

Therefore, the maximum acceleration for rigid equipment is:

$$\begin{aligned} \text{Acceleration} &= F_p/W_p \\ &= Z I_p C_p \\ &= 0.4 \times 1.5 \times 0.75 \\ &= 0.45g \end{aligned}$$

The maximum acceleration for flexible equipment is:

$$\begin{aligned} \text{Acceleration} &= F_p/W_p \\ &= Z I_p C_p \\ &= 0.4 \times 1.5 \times 1.5 \\ &= 0.9g \end{aligned}$$

Flexible equipment is defined in the UBC as equipment with a period of vibration equal to or greater than 0.06 seconds. This period of vibration corresponds to a dominant frequency of vibration equal to 16.7 Hz.

Equipment must be designed and tested to the UBC requirements to determine that it will be functional following a seismic event. In addition, a structural or civil engineer must perform calculations based on data received from the equipment manufacturer specifying the size, weight, center of gravity, and mounting provisions of the equipment to determine its method of attachment so it will remain attached to its foundation during a seismic event. Finally, the contractor must properly install the equipment in accordance with the anchorage design.

NOTES

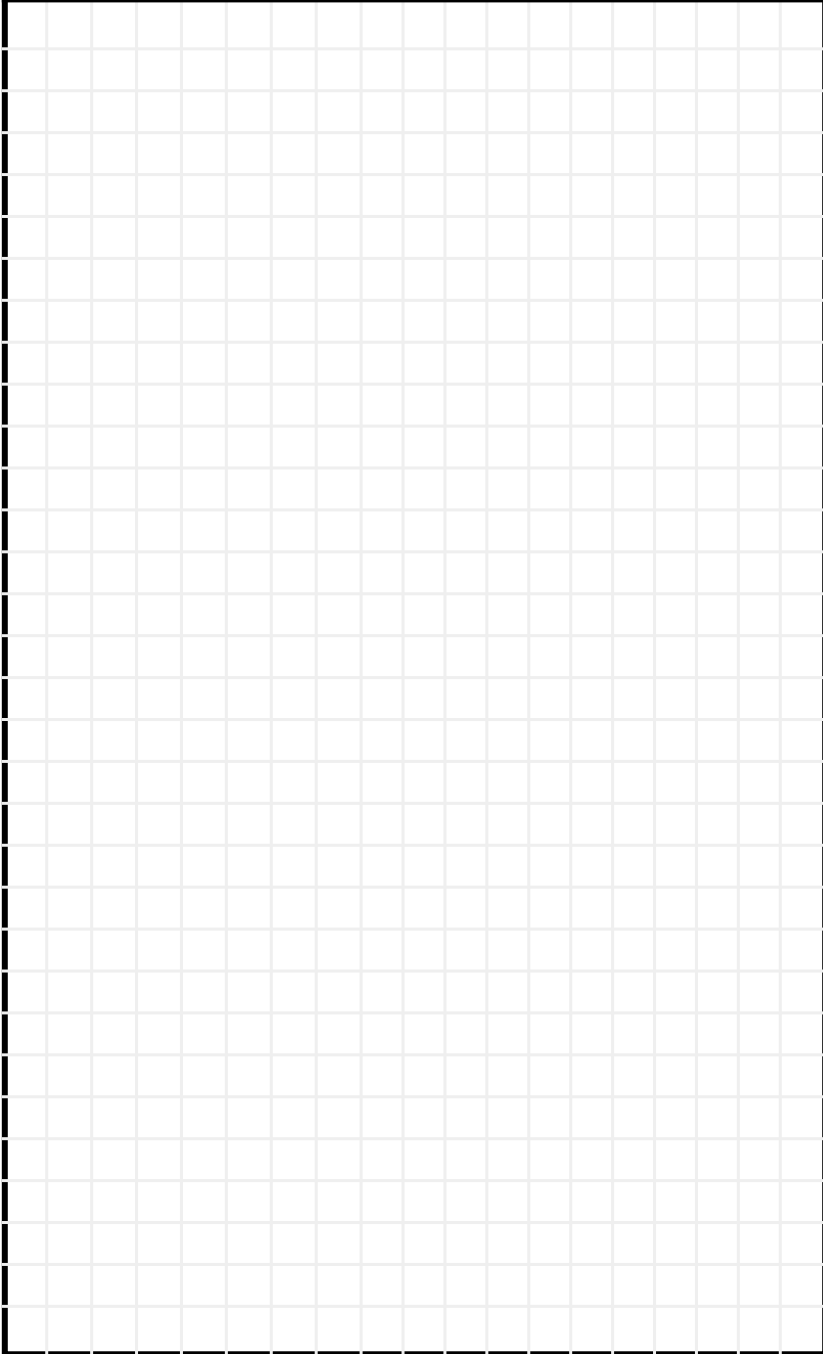

NOTES

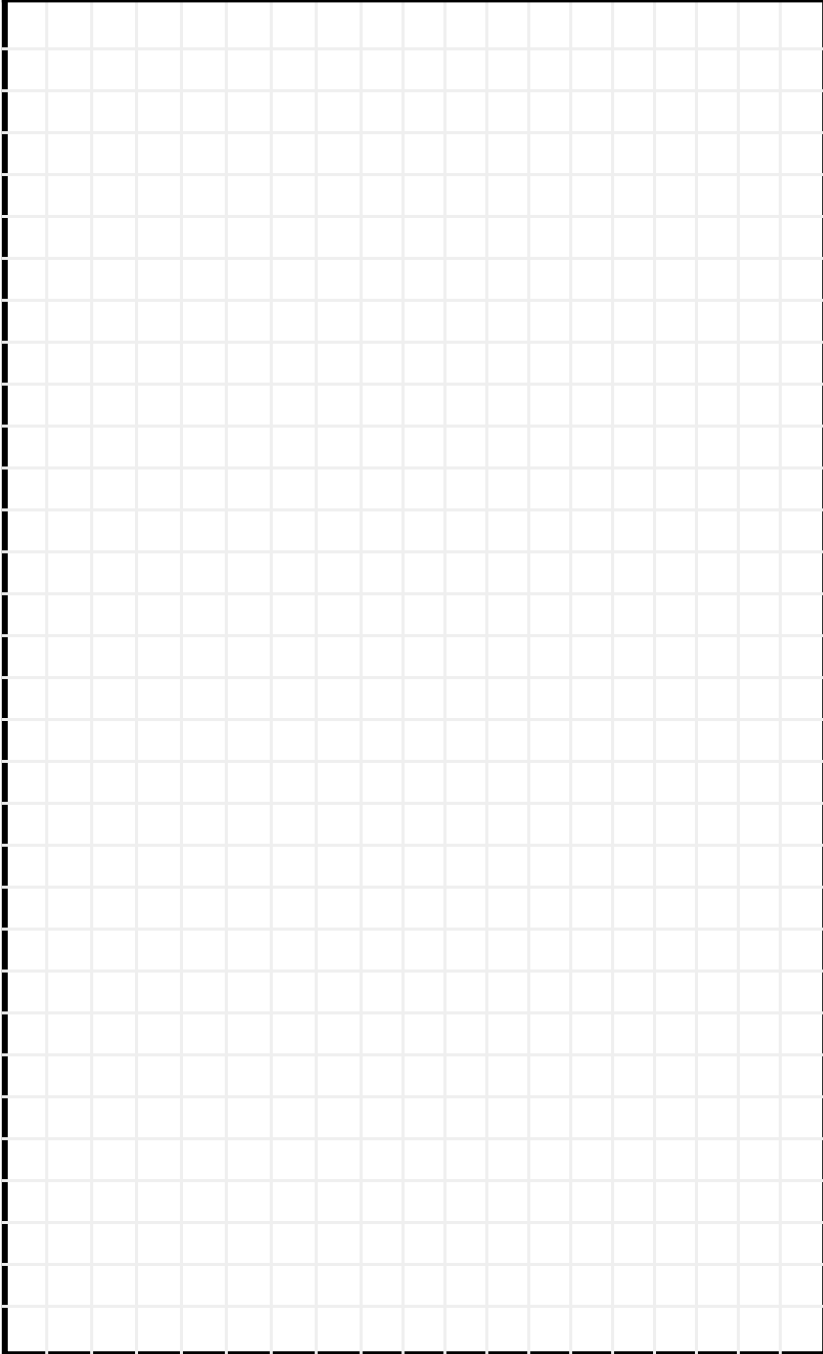

CHAPTER TWO

National Electrical Code (NEC) Articles, Tables, and Data

2.0 WORKING SPACE ABOUT ELECTRIC EQUIPMENT

Introduction

The National Electrical Code (NEC), produced by the National Fire Protection Association (NFPA), is known as NFPA-70 and is the “bible” of electrical design and construction. It is developed and written by a committee of some of the best electrical professionals who are knowledgeable in the safe and effective design, construction, operation, and maintenance of electrical systems, with input from the industry at large. It sets forth the *minimum* standards by which electrical systems should be designed and constructed.

While complying with the NEC minimum requirements will ensure safe and effective electrical system design and operation, good design practice often dictates that more stringent requirements be met, or more stringent requirements may be mandated by the local electrical inspector. Keep in mind that the authority having final jurisdiction for acceptance of an electrical system’s design and installation is the local electrical inspector for the project. It may be prudent, therefore, to involve the local electrical inspector in the early stages of design and from time to time throughout the design process in order to help him or her become familiar with the project and your design intent and to see if there are any special requirements or possible differences in interpretation of the NEC, and thus to facilitate a design that will not only be safe and effective, but will be accepted with no costly surprises once in construction.

Interpretations of the NEC can be obtained from the NFPA both formally and informally, with the latter being the quickest. This is sometimes needed for clarification of *Code* articles that may be subject to broad interpretation of the *Code*’s intent.

This part of the handbook brings together in one convenient location the NEC articles, tables, and data used most frequently by electrical design professionals. For the most part, NEC articles are only referenced for the applicable topic, or are abstracted, highlighted, or abbre-

viated, without the full text. Tables and data from the NEC are given in their entirety. The user is encouraged to read the complete text of the NEC article under consideration for more comprehensive understanding, cross-references to related NEC articles, and total context.

The article immediately following, NEC Article 110.26, is repeated in its entirety.

**NEC Article 110.26: Spaces About Electrical Equipment
(600 Volts, Nominal, or Less)**

Sufficient access and working space shall be provided and maintained about all electric equipment to permit ready and safe operation and maintenance of such equipment. Enclosures housing electrical apparatus that are controlled by lock and key shall be considered accessible to qualified persons.

(A) WORKING SPACE

Working space for equipment operating at 600 volts, nominal, or less to ground and likely to require examination, adjustment, servicing, or maintenance while energized shall comply with the dimensions of 110.26(A)(1), (2), and (3) or as required elsewhere in this *Code*.

(1) Depth of Working Space

The depth of the working space in the direction of live parts shall not be less than that specified in Table 2.1 [NEC Table 110.26(A)(1)] unless the requirements of 110.26(A)(1)(a), (b), or (c) are met. Distances shall be measured from the exposed live parts or from the enclosure or opening if the live parts are enclosed.

Examples of Conditions 1, 2, and 3 are shown in Fig. 2.1 (NEC Handbook Exhibit 110.7).

(A) DEAD-FRONT ASSEMBLIES

Working space shall not be required in the back or sides of assemblies, such as dead-front switchboards or motor control centers, where all connections and all renewable or adjustable parts, such as fuses or switches, are accessible from locations other than the back or sides. Where rear access is required to work on nonelectrical parts on the back of enclosed equipment, a minimum horizontal working space of 762 mm (30 in.) shall be provided. See Fig. 2.2 (NEC Handbook Exhibit 110.8).

(B) LOW VOLTAGE

By special permission, smaller work spaces shall be permitted where all uninsulated parts operate at not greater than 30 volts rms, 42 volts peak, or 60 volts DC.

TABLE 2.1 NEC Table 110.26(A)(1): Working Spaces

Nominal Voltage to Ground	Minimum Clear Distance		
	Condition 1	Condition 2	Condition 3
0–150	900 mm (3 ft)	900 mm (3 ft)	900 mm (3 ft)
151–600	900 mm (3 ft)	1 m (3½ ft)	1.2 m (4 ft)

Note: Where the conditions are as follows:

Condition 1 — Exposed live parts on one side and no live or grounded parts on the other side of the working space, or exposed live parts on both sides effectively guarded by suitable wood or other insulating materials. Insulated wire or insulated busbars operating at not over 300 volts to ground shall not be considered live parts.

Condition 2 — Exposed live parts on one side and grounded parts on the other side. Concrete, brick, or tile walls shall be considered as grounded.

Condition 3 — Exposed live parts on both sides of the work space (not guarded as provided in Condition 1) with the operator between.

(c) EXISTING BUILDINGS

In existing buildings where equipment is being replaced, Condition 2 working clearance shall be permitted between dead-front switchboards, panelboards, or motor control centers located across the aisle from each other where conditions of maintenance and supervision ensure that written procedures have been adopted to prohibit equipment on both sides of the aisle from being open at the same time and qualified persons who are authorized will service the installation. See Fig. 2.3 (NEC Handbook Exhibit 110.9) for an example of this condition.

(2) *Width of Working Space*

The width of the working space in front of the electric equipment shall be the width of the equipment or 750 mm (30 in.), whichever is greater. In all cases, the work space shall permit at least a 90° opening of equipment doors or hinged panels. Refer to Figs. 2.4 and 2.5 (NEC Handbook Exhibits 110.10 and 110.11, respectively) for examples of these conditions.

FIGURE 2.1. Examples of conditions 1, 2, and 3 for Table 2.1.

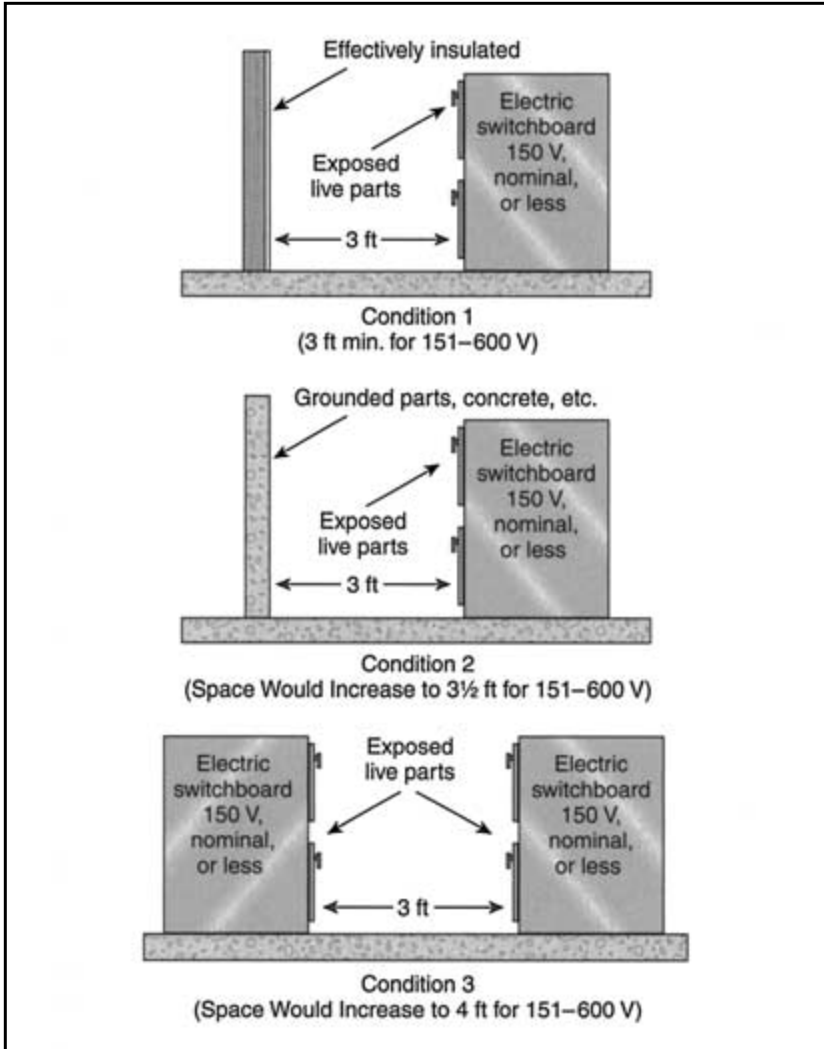

(3) Height of Working Space

The work space shall be clear and extend from the grade, floor, or platform to the height required by 110.26(E). Within the height requirements of this section, other equipment that is associated with the electrical installation and is located above or below the electrical equipment shall be permitted to extend not more than 150 mm (6 in.) beyond the front of the electrical equipment.

FIGURE 2.2. Example of the 30-in. working space at the rear of equipment to allow work on nonelectrical parts.

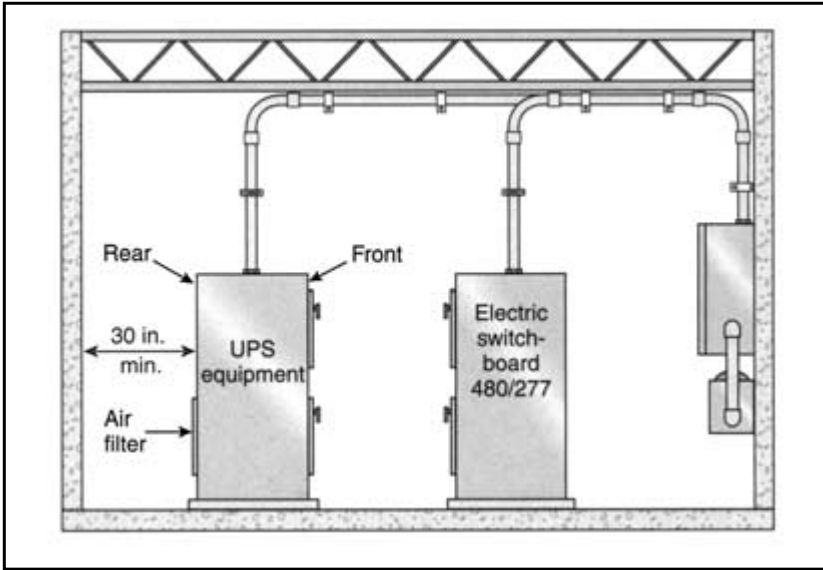

FIGURE 2.3. Permitted reduction from a Condition 3 to a Condition 2 clearance according to 110.26(A)(1)(c).

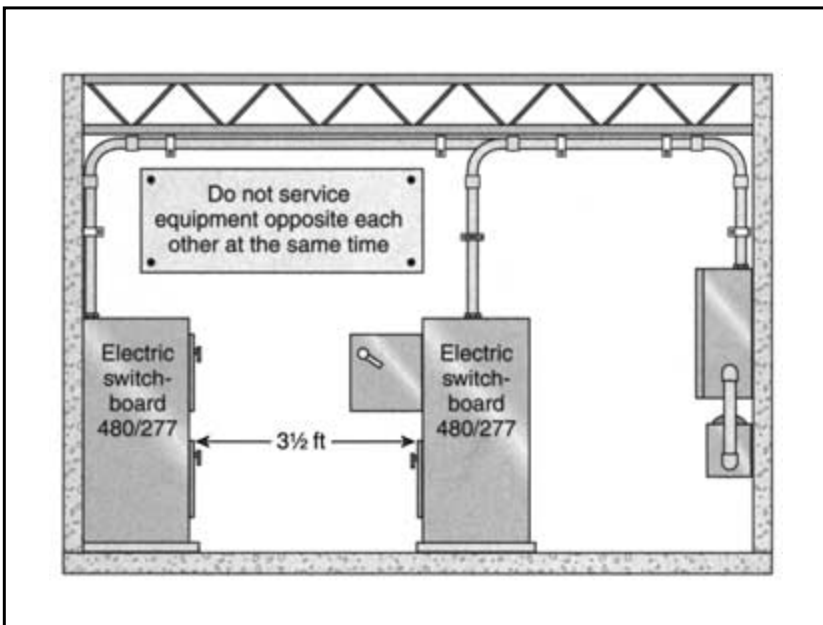

FIGURE 2.4. The 30-in.-wide front working space not required to be directly centered on the electrical equipment if space is sufficient for safe operation and maintenance of such equipment.

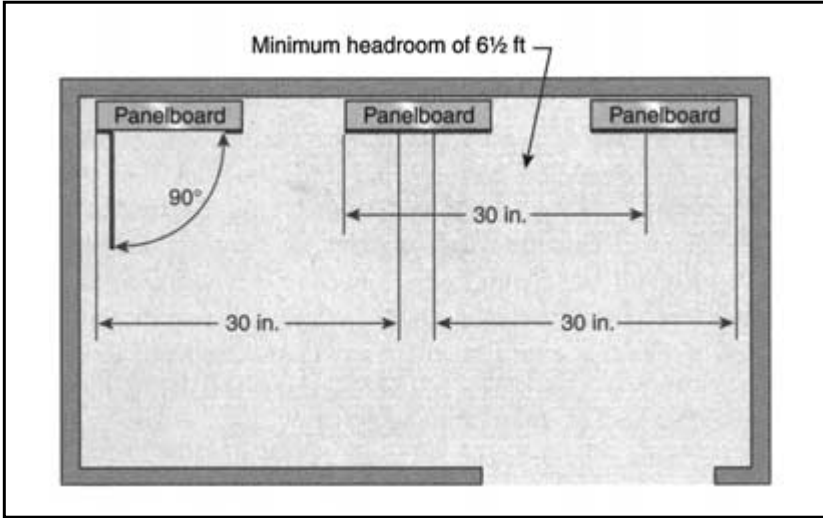
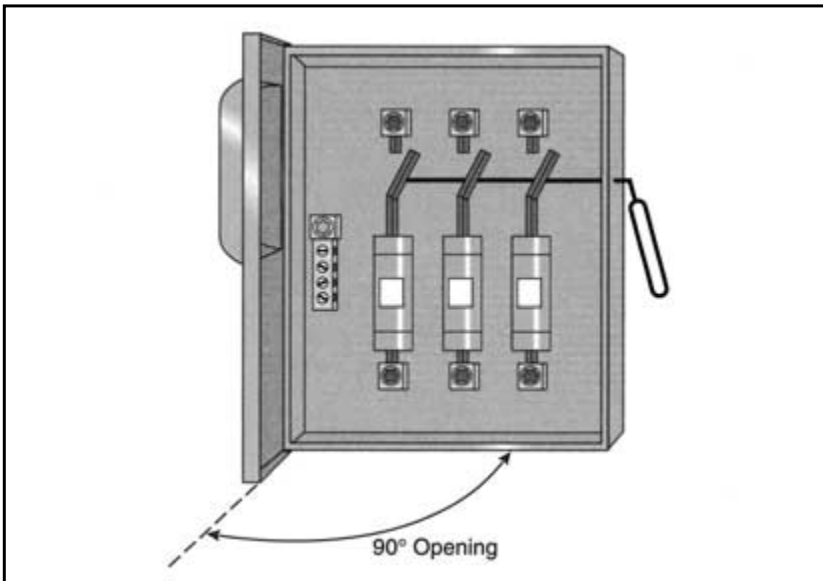

FIGURE 2.5. Equipment doors required to open a full 90° to ensure a safe working space.



(B) CLEAR SPACES

Working space required by this section shall not be used for storage. When normally enclosed live parts are exposed for inspection or servicing, the working space, if in a passageway or general open space, shall be suitably guarded.

(C) ENTRANCE TO WORKING SPACE*(1) Minimum Required*

At least one entrance of sufficient area shall be provided to give access to working space about electrical equipment.

(2) Large Equipment

For equipment rated 1200 amperes or more and over 1.8 m (6 ft) wide that contains overcurrent devices, switching devices, or control devices, there shall be one entrance to the required working space not less than 610 mm (24 in.) wide and 2.0 m (6½ ft) high at each end of the working space. Where the entrance has a personnel door(s), the door(s) shall open in the direction of egress and be equipped with panic bars, pressure plates, or other devices that are normally latched but open under simple pressure. See Figs. 2.6 and 2.7 (NEC Handbook Exhibits 110.12 and 110.13, respectively).

An example of an unacceptable arrangement of a large switchboard is shown in Fig. 2.8 (NEC Handbook Exhibit 110.14).

A single entrance to the required working space shall be permitted where either of the conditions in 110.26(C)(2)(a) or (b) is met.

(A) UNOBSTRUCTED EXIT

Where the location permits a continuous and unobstructed way of exit travel, a single entrance to the working space shall be permitted. See Fig. 2.9 (NEC Handbook Exhibit 110.15) for an example of this condition.

(B) EXTRA WORKING SPACE

Where the depth of the working space is twice that required by 110.26(A)(1), a single entrance shall be permitted. It shall be located so that the distance to the nearest edge of the entrance is not less than the minimum clear distance specified in Table 110.26(A)(1) for equipment operating at that voltage and in that condition. Refer to Fig. 2.10 (NEC Handbook Exhibit 110.16) for an example of this condition.

(D) ILLUMINATION

Illumination shall be provided for all working spaces about service equipment, switchboards, panelboards, or motor control centers installed indoors. Additional lighting outlets shall not be required where the work

FIGURE 2.6. Basic Rule, first paragraph. At least one entrance is required to provide access to the working space around electrical equipment [110.26(C)(1)]. The lower installation would not be acceptable for a switchboard over 6 ft wide and rated 1200 amperes or more.

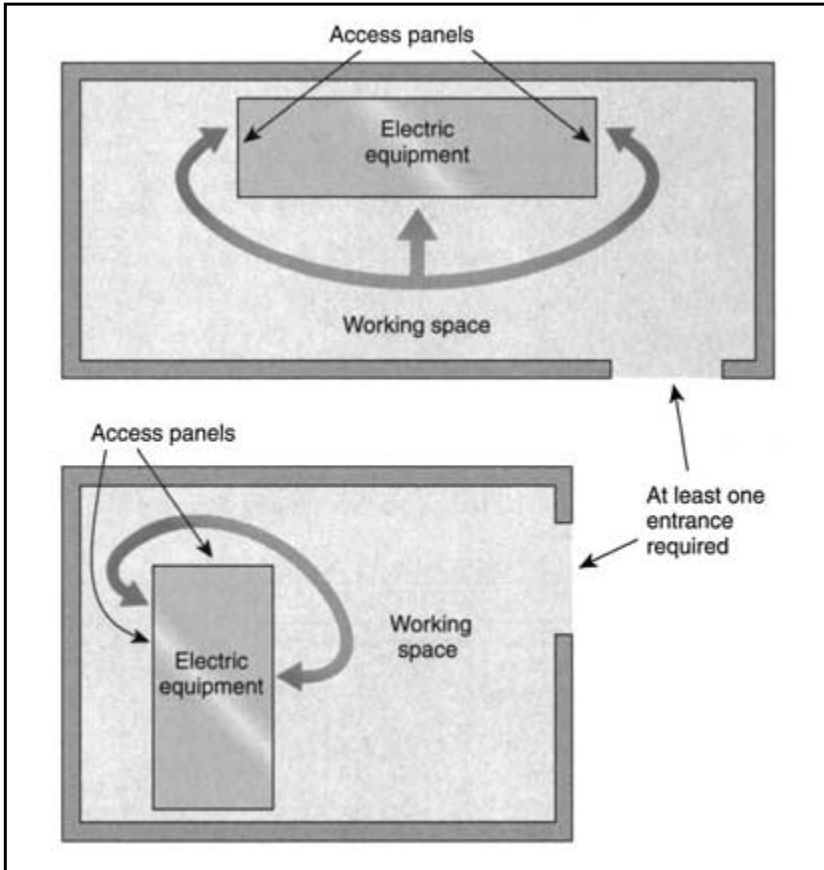

space is illuminated by an adjacent light source or as permitted by 210.70(A)(1), Exception No. 1, for switched receptacles. In electrical equipment rooms, the illumination shall not be controlled by automatic means only.

(E) HEADROOM

The minimum headroom of working spaces about service equipment, switchboards, panelboards, or motor control centers shall be 2.0 m (6½ ft). Where the electrical equipment exceeds 2.0 m (6½ ft) in height,

FIGURE 2.7. Basic Rule, second paragraph. For equipment rated 1200 amperes or more and over 6 ft wide, one entrance not less than 24 in. wide and 6½ ft high is required at each end [110.26(C)(2)].

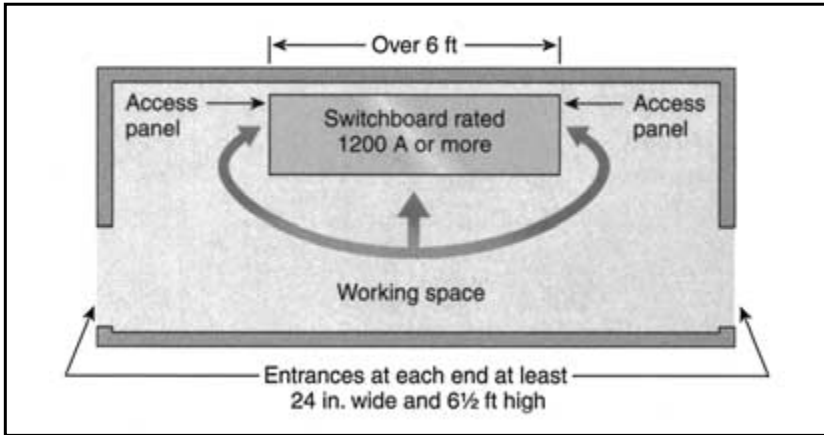

the minimum headroom shall not be less than the height of the equipment.

Exception. In existing dwelling units, service equipment or panelboards that do not exceed 200 amperes shall be permitted in spaces where the headroom is less than 2.0 m (6½ ft).

FIGURE 2.8. Unacceptable arrangement of a large switchboard. A person could be trapped behind arcing electrical equipment.

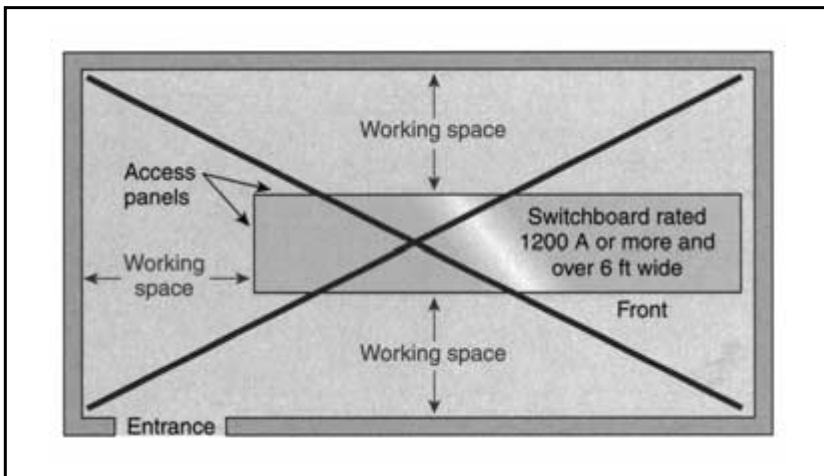

FIGURE 2.9. Equipment location allowing a continuous and unobstructed way of exit travel.

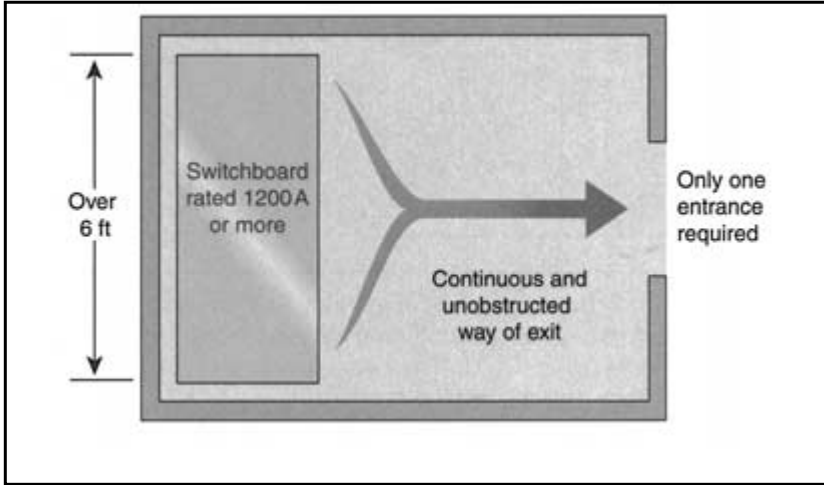
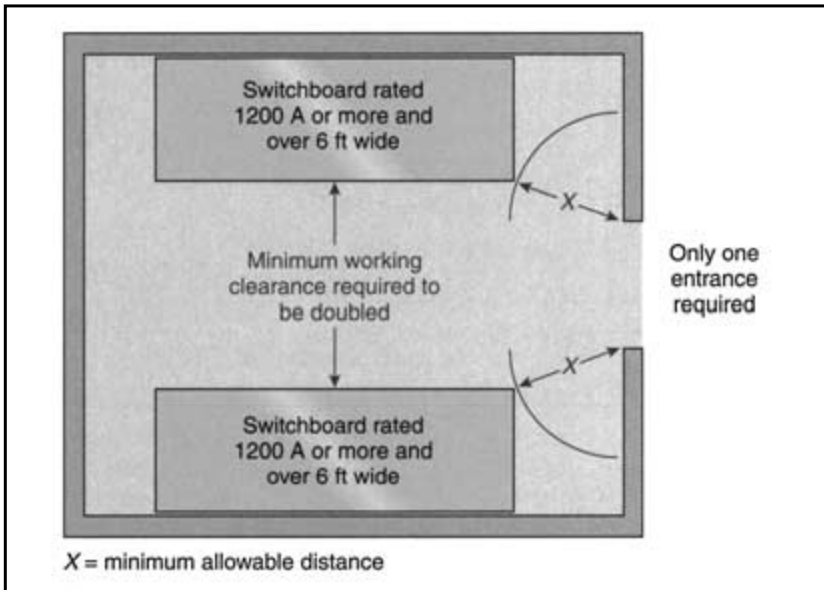

FIGURE 2.10. Working space with one entrance. Only one entrance is required if the working space required by 110.26(A) is doubled. See Table 2.1 for permitted dimensions of X.



(F) DEDICATED EQUIPMENT SPACE

All switchboards, panelboards, distribution boards, and motor control centers shall be located in dedicated spaces and protected from damage.

Exception. Control equipment that by its very nature or because of other rules of the *Code* must be adjacent to or within sight of its operating machinery shall be permitted in those locations.

(1) Indoor

Indoor installations shall comply with 110.26(F)(1)(a) through (d).

(A) DEDICATED ELECTRICAL SPACE

The space equal to the width and depth of the equipment and extending from the floor to a height of 1.8 m (6 ft) above the equipment or to the structural ceiling, whichever is lower, shall be dedicated to the electrical installation. No piping, ducts, leak protection apparatus, or other equipment foreign to the electrical installation shall be located in this zone.

Exception. Suspended ceilings with removable panels shall be permitted within the 1.8 m (6 ft) zone.

(B) FOREIGN SYSTEMS

The area above the dedicated space required by 110.26(F)(1)(a) shall be committed to contain foreign systems, provided protection is installed to avoid damage to the electrical equipment from condensation, leaks, or breaks in such foreign systems.

(C) SPRINKLER PROTECTION

Sprinkler protection shall be permitted for the dedicated space where the piping complies with this section.

(D) SUSPENDED CEILINGS

A dropped, suspended, or similar ceiling that does not add strength to the building structure shall not be considered a structural ceiling.

(2) Outdoor

Outdoor electrical equipment shall be installed in suitable enclosures and shall be protected from accidental contact by unauthorized personnel, or by vehicular traffic, or by accidental spillage or leakage from piping systems. The working clearance space shall include the zone described in 110.26(A). No architectural appurtenance or other equipment shall be located in this zone.

Figures 2.11, 2.12, and 2.13 (NEC Handbook Figures 110.17, 110.18, and 110.19, respectively) show the two distinct indoor installation spaces required by 110.26(A) and 110.26(F): the working space and the dedicated electrical space; the working space in front of a panelboard as required by 110.26(A), Fig. 2.12 (supplements Fig. 2.11), and

Fig. 2.13, the dedicated electrical space above and below a panelboard as required by 110.26(F)(1).

2.1 OVER 600 VOLTS, NOMINAL

For working space over 600 volts, nominal, refer to NEC articles 110.30 through 110.40, inclusive, which supplement or modify the preceding articles that also apply.

In no case do the provisions of this part apply to the equipment on the supply side of the service point. Equipment on the supply side of the service point is outside the scope of the NEC. Such equipment is covered by the *National Electrical Safety Code* (ANSI C2), published by the Institute of Electrical and Electronics Engineers (IEEE).

Generally speaking, in most applications involving electrical equipment over 600 volts, nominal, encountered by electrical design profes-

FIGURE 2.11. The two distinct installation spaces required by 110.26(A) and 110.26(F): the working space and the dedicated electrical space.

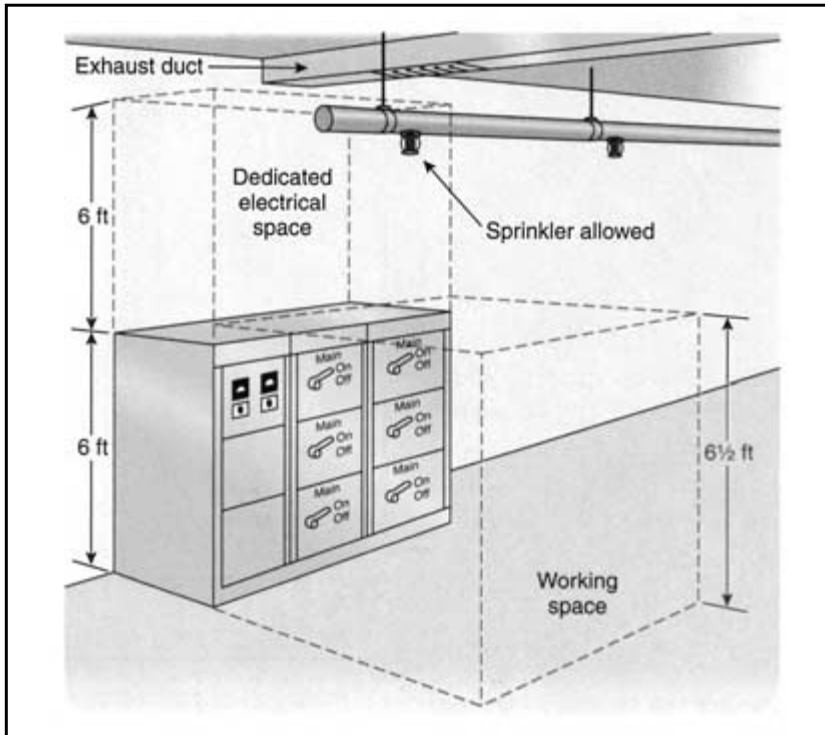
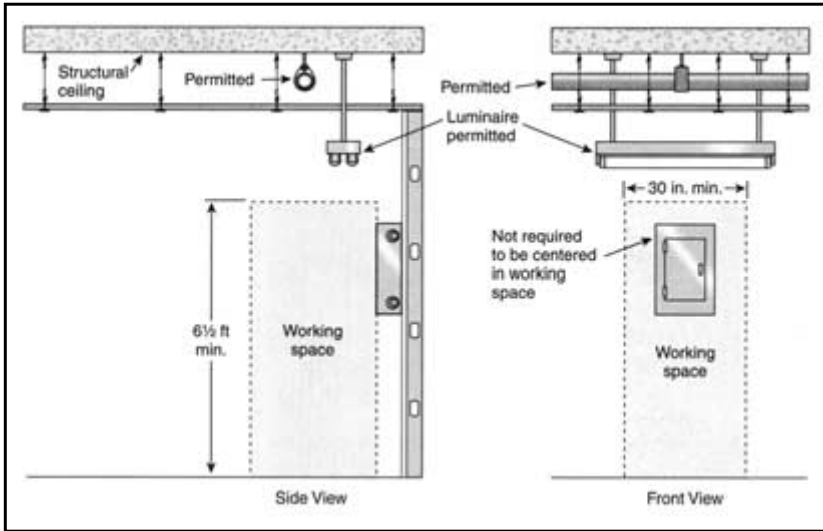

FIGURE 2.12. The working space in front of a panelboard as required by 110.26(A). This illustration supplements the dedicated electrical space shown in Fig. 2.11.



sionals in the building industry, the equipment is in metal-enclosed switchgear located in secure rooms or vaults accessible to qualified persons only.

NEC Article 110.34. Work Space and Guarding

WORKING SPACE

Except as elsewhere required or permitted in this *Code*, the minimum clear working space in the direction of access to live parts of electrical equipment shall not be less than specified in Table 2.2 [NEC Table 110.34(A)]. Distances shall be measured from live parts, if such are exposed, or from the enclosure front or opening if such are enclosed.

Exception: Working space shall not be required in back of equipment such as dead-front switchboards or control assemblies where there are no renewable or adjustable parts (such as fuses or switches) on the back and where all connections are accessible from locations other than the back. Where rear access is required to work on de-energized parts on the back of enclosed equipment, a minimum working space of 750 mm (30 in.) horizontally shall be provided.

FIGURE 2.13. The dedicated electrical space above and below a panelboard as required by 110.26(F)(1).

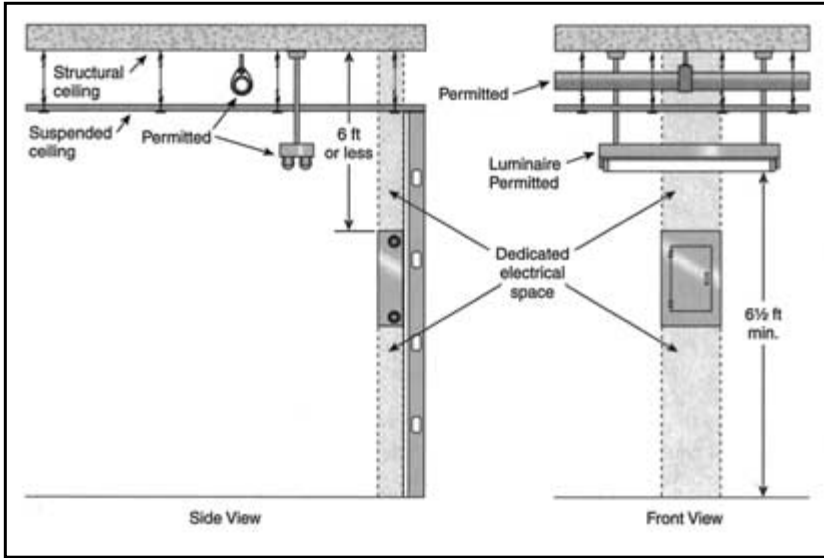

Elevation of Unguarded Live Parts Above Working Space

Table 2.3 [NEC Table 110.34(E)] gives the elevation of unguarded live parts above working space.

2.2 OVERCURRENT PROTECTION STANDARD AMPERE RATINGS

NEC Article 240.6, Standard Ampere Ratings, is repeated here in its entirety.

240.6 Standard Ampere Ratings

(A) FUSES AND FIXED-TRIP CIRCUIT BREAKERS

The standard ampere ratings for fuses and inverse time circuit breakers shall be considered 15, 20, 25, 30, 35, 40, 45, 50, 60, 70, 80, 90, 100, 110, 125, 150, 175, 200, 225, 250, 300, 350, 400, 450, 500, 600, 700, 800, 1000, 1200, 1600, 2000, 2500, 3000, 4000, 5000, and 6000 amperes.

Additional standard ampere ratings for fuses shall be considered 1, 3, 6, 10, and 601. The use of fuses and inverse time circuit breakers with nonstandard ampere ratings shall be permitted.

TABLE 2.2 NEC Table 110.34(A): Minimum Depth of Clear Working Space at Electrical Equipment

Nominal Voltage to Ground	Minimum Clear Distance		
	Condition 1	Condition 2	Condition 3
601–2500 V	900 mm (3 ft)	1.2 m (4 ft)	1.5 m (5 ft)
2501–9000 V	1.2 m (4 ft)	1.5 m (5 ft)	1.8 m (6 ft)
9001–25,000 V	1.5 m (5 ft)	1.8 m (6 ft)	2.8 m (9 ft)
25,001V–75 kV	1.8 m (6 ft)	2.5 m (8 ft)	3.0 m (10 ft)
Above 75 kV	2.5 m (8 ft)	3.0 m (10 ft)	3.7 m (12 ft)

Note: Where the conditions are as follows:

Condition 1— Exposed live parts on one side and no live or grounded parts on the other side of the working space, or exposed live parts on both sides effectively guarded by suitable wood or other insulating materials. Insulated wire or insulated busbars operating at not over 300 volts shall not be considered live parts.

Condition 2— Exposed live parts on one side and grounded parts on the other side. Concrete, brick, or tile walls shall be considered as grounded surfaces.

Condition 3— Exposed live parts on both sides of the work space (not guarded as provided in Condition 1) with the operator between.

TABLE 2.3 NEC Table 110.34(E): Elevation of Unguarded Live Parts Above Working Space

Nominal Voltage Between Phases	Elevation	
	m	ft
601–7500 V	2.8	9
7501–35,000 V	2.9	9½
Over 35 kV	2.9 m + 9.5 mm/kV above 35	9½ ft + 0.37 in./kV above 35

(B) ADJUSTABLE-TRIP CIRCUIT BREAKERS

The rating of adjustable-trip circuit breakers having external means for adjusting the current setting (long-time pickup setting) not meeting the requirements of 240.6(C) shall be the maximum setting possible.

(C) RESTRICTED ACCESS ADJUSTABLE-TRIP CIRCUIT BREAKERS

A circuit breaker(s) that has restricted access to the adjusting means shall be permitted to have an ampere rating(s) that is equal to the adjusted current setting (long-time pickup setting). Restricted access shall be defined as located behind one of the following:

1. Removable and sealable covers over the adjusting means
2. Bolted equipment enclosure doors
3. Locked doors accessible only to qualified personnel

2.3 NEC ARTICLE 240.21: LOCATION IN CIRCUIT (FEEDER TAP RULES)

This article is repeated in its entirety.

240.21. Location in Circuit

Overcurrent protection shall be provided in each ungrounded circuit conductor and shall be located at the point where the conductors receive their supply except as specified in 240.21(A) through (G). No conductor supplied under the provisions of 240.21(A) through (G) shall supply another conductor under those provisions, except through an overcurrent protective device meeting the requirements of 240.4. See Fig. 2.14 (NEC Handbook Exhibit 240.7) for an example of this condition.

(A) BRANCH-CIRCUIT CONDUCTORS

Branch-circuit tap conductors meeting the requirements specified in 210.19 shall be permitted to have overcurrent protection located as specified in that section.

(B) FEEDER TAPS

Conductors shall be permitted to be tapped, without overcurrent protection at the tap, to a feeder as specified in 240.21(B)(1) through (5).

FIGURE 2.14. An example in which the circuit breaker protecting the feeder conductors is permitted by 240.21(A) to protect the tap conductors to the cabinet.

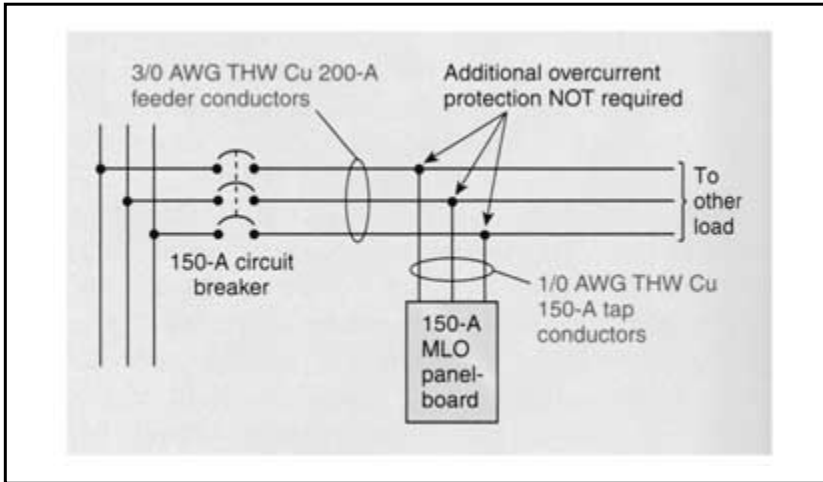

(1) TAPS NOT OVER 3 M (10 FT) LONG

Where the length of the tap conductors does not exceed 3 m (10 ft) and the tap conductors comply with all of the following:

1. The ampacity of the tap conductors is:
 - a. Not less than the combined computed loads on the circuits supplied by the tap conductors, and
 - b. Not less than the rating of the device supplied by the tap conductors or not less than the rating of the overcurrent-protective device at the termination of the tap conductors.
2. The tap conductors do not extend beyond the switchboard, panelboard, disconnecting means, or control devices they supply.
3. Except at the point of connection to the feeder, the tap conductors are enclosed in a raceway, which shall extend from the tap to the enclosure of an enclosed switchboard, panelboard, or control devices, or to the back of an open switchboard.
4. For field installations where the tap conductors leave the enclosure or vault where the tap is made, the rating of the overcurrent device on the line side of the tap conductors shall not exceed 10 times the ampacity of the tap conductor.

NOTE For overcurrent protection requirements for lighting and appliance branch-circuit panelboards and certain power panelboards, see 408.16(A),(B), and (E).

(2) FEEDER TAPS NOT OVER 7.5 M (25 FT) LONG

Where the length of the tap conductors does not exceed 7.5 m (25 ft) and the tap conductors comply with all of the following:

1. The ampacity of the tap conductors is not less than one-third of the rating of the overcurrent device protecting the feeder conductors.
2. The tap conductors terminate in a single circuit breaker or a single set of fuses that will limit the load to the ampacity of the tap conductors. This device shall be permitted to supply any number of additional overcurrent devices on its load side.
3. The tap conductors are suitably protected from physical damage or are enclosed in a raceway.

Figure 2.15 (NEC Handbook Exhibit 240.8) shows an example of tap conductors terminating in a single circuit breaker.

(3) TAPS SUPPLYING A TRANSFORMER (PRIMARY PLUS SECONDARY) NOT OVER 7.5 M (25 FT) LONG

Where the tap conductors supply a transformer and comply with all of the following:

1. The conductors supplying the primary of a transformer have an ampacity at least one-third of the rating of the overcurrent device protecting the feeder conductors.
2. The conductors supplied by the secondary of the transformer have an ampacity that, when multiplied by the ratio of the secondary-to-primary voltage, is at least one-third of the rating of the overcurrent device protecting the feeder conductors.
3. The total length of one primary plus one secondary conductor, excluding any portion of the primary conductor that is protected at its ampacity, is not over 7.5 m (25 ft).
4. The primary and secondary conductors are suitably protected from physical damage.
5. The secondary conductors terminate in a single circuit breaker or set of fuses that will limit the load current to not more than the conductor ampacity that is permitted by 310.15.

Figure 2.16 (NEC Handbook Exhibit 240.9) illustrates the conditions of 240.21(B)(3).

FIGURE 2.15. An example in which the feeder taps terminate in a single circuit breaker, per 240.21(B)(2).

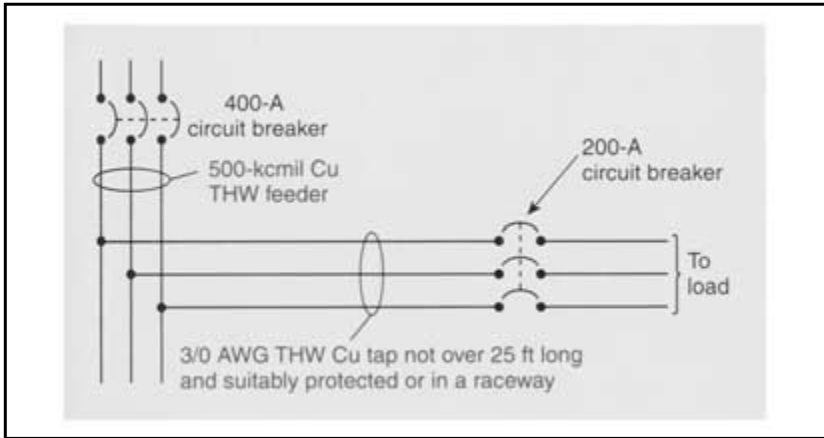

(4) TAPS OVER 7.5 M (25 FT) LONG

Where the feeder is in a high bay manufacturing building over 11 m (35 ft) high at walls and the installation complies with all of the following:

1. Conditions of maintenance and supervision ensure that only qualified persons will service the systems.

FIGURE 2.16. An example in which the transformer feeder taps (primary plus secondary) are not over 25 ft long, per 240.21(B)(3).

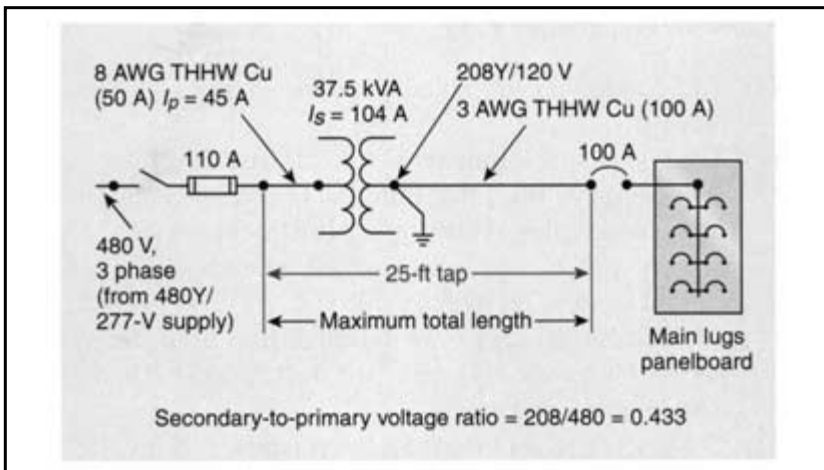

2. The tap conductors are not over 7.5 m (25 ft) long horizontally and not over 30 m (100 ft) total length.
3. The ampacity of the tap conductors is not less than one-third the rating of the overcurrent device protecting the feeder conductors.
4. The tap conductors terminate at a single circuit breaker or a single set of fuses that will limit the load to the ampacity of the tap conductors. This single overcurrent device shall be permitted to supply any number of additional overcurrent devices on its load side.
5. The tap conductors are suitably protected from physical damage or are enclosed in a raceway.
6. The tap conductors are continuous from end to end and contain no splices.
7. The tap conductors are sized 6 AWG copper or 4 AWG aluminum or larger.
8. The tap conductors do not penetrate walls, floors, or ceilings.
9. The tap is made no less than 9 m (30 ft) from the floor.

Figure 2.17 (NEC Handbook Exhibit 240.10) provides an example of compliance with 240.21(B)(4).

(5) OUTSIDE TAPS OF UNLIMITED LENGTH

Where the conductors are located outdoors of a building or structure, except at the point of load termination, and comply with all of the following conditions:

1. The conductors are suitably protected from physical damage.
2. The conductors terminate at a single circuit breaker or a single set of fuses that limit the load to the ampacity of the conductors. This single overcurrent device shall be permitted to supply any number of additional overcurrent devices on its load side.
3. The overcurrent device for the conductors is an integral part of a disconnecting means or shall be located immediately adjacent thereto.
4. The disconnecting means for the conductors is installed at a readily accessible location complying with one of the following:
 - a. Outside of a building or structure
 - b. Inside, nearest the point of entrance of the conductors
 - c. Where installed in accordance with 230.6, nearest the point of entrance of the conductors

FIGURE 2.17. An example in which the feeder taps are over 25 ft long, the tap connection being not less than 30 ft from the floor, per 240.21(B)(4).

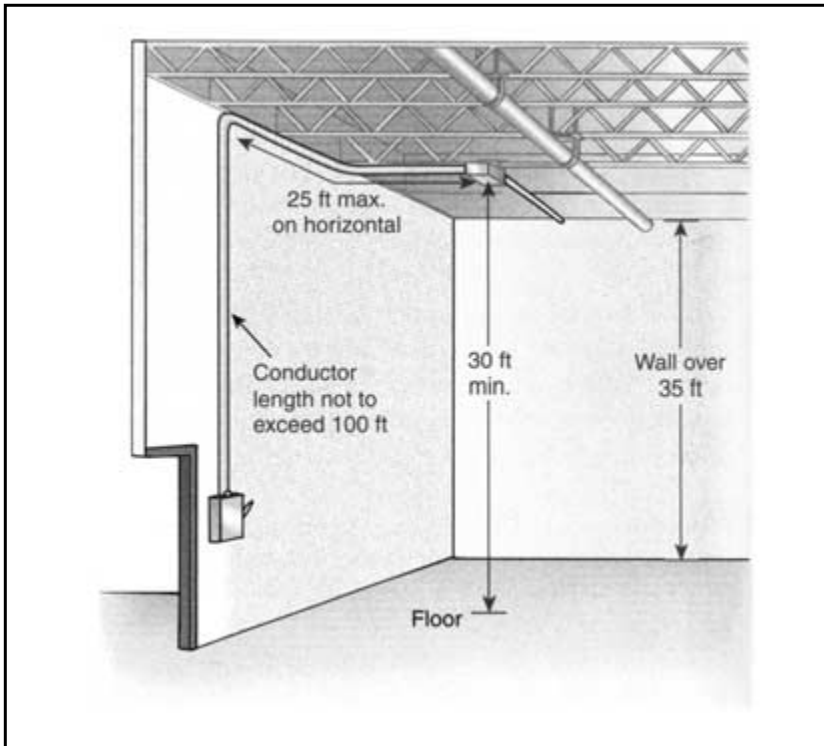

(C) TRANSFORMER SECONDARY CONDUCTORS

Conductors shall be permitted to be connected to a transformer secondary, without overcurrent protection at the secondary, as specified in 240.21(C)(1) through (6).

NOTE For overcurrent protection requirements for transformers, see 450.3.

(1) PROTECTION BY PRIMARY OVERCURRENT DEVICE

Conductors supplied by the secondary side of a single-phase transformer having a 2-wire (single-voltage) secondary, or a three-phase, delta-delta connected transformer having a 3-wire (single-voltage) sec-

ondary, shall be permitted to be protected by an overcurrent protection provided on the primary (supply) side of the transformer, provided this protection is in accordance with 450.3 and does not exceed the value determined by multiplying the secondary conductor ampacity by the secondary to primary voltage ratio.

Single-phase (other than 2-wire) and multiphase (other than delta-delta, 3-wire) transformer secondary conductors are not considered to be protected by the primary overcurrent protective device.

(2) TRANSFORMER SECONDARY CONDUCTORS NOT OVER 3 M (10 FT) LONG

Where the length of secondary conductor does not exceed 3 m (10 ft) and complies with all of the following:

1. The ampacity of the secondary conductors is
 - a. Not less than the combined computed loads on the circuits supplied by the secondary conductors, and
 - b. Not less than the rating of the device supplied by the secondary conductors or not less than the rating of the overcurrent protective device at the termination of the secondary conductors.
2. The secondary conductors do not extend beyond the switchboard, panelboard, disconnecting means, or control devices they supply.
3. The secondary conductors are enclosed in a raceway, which shall extend from the transformer to the enclosure of an enclosed switchboard, panelboard, or control devices or to the back of an open switchboard.

NOTE For overcurrent protection requirements for lighting and appliance branch-circuit panelboards and certain power panelboards, see 408.16(A),(B), and (E).

(3) INDUSTRIAL INSTALLATION SECONDARY CONDUCTORS NOT OVER 7.5 M (25 FT) LONG

For industrial installations only, where the length of the secondary conductors does not exceed 7.5 m (25 ft) and complies with all of the following:

1. The ampacity of the secondary conductors is not less than the secondary current rating of the transformer, and the sum of the ratings of the overcurrent devices does not exceed the ampacity of the secondary conductors.
2. All overcurrent devices are grouped.
3. The secondary conductors are suitably protected from physical damage.

(4) OUTSIDE SECONDARY OF BUILDING OR STRUCTURE CONDUCTORS

Where the conductors are located outside of a building or structure, except at the point of load termination, and comply with all of the following:

1. The conductors are suitably protected from physical damage.
2. The conductors terminate at a single circuit breaker or a single set of fuses that limit the load to the ampacity of the conductors. This single overcurrent device shall be permitted to supply any number of additional overcurrent devices on its load side.
3. The overcurrent device for the conductors is an integral part of a disconnecting means or shall be immediately adjacent thereto.
4. The disconnecting means for the conductors is installed at a readily accessible location complying with one of the following:
 - a. Outside of a building or structure
 - b. Inside, nearest the point of entrance of the conductors
 - c. Where installed in accordance with 230.6, nearest the point of entrance of the conductors

(5) SECONDARY CONDUCTORS FROM A FEEDER TAPPED TRANSFORMER

Transformer secondary conductors installed in accordance with 240.21(B)(3) shall be permitted to have overcurrent protection as specified in that section.

(6) SECONDARY CONDUCTORS NOT OVER 7.5 M (25 FT) LONG

Where the length of the secondary conductor does not exceed 7.5 m (25 ft) and complies with all of the following:

1. The secondary conductors shall have an ampacity that, when multiplied by the ratio of the secondary-to-primary voltage, is at least one-third of the rating of the overcurrent device protecting the primary of the transformer.
2. The secondary conductors terminate in a single circuit breaker or set of fuses that limit the load current to not more than the conductor ampacity that is permitted by 310.15.
3. The secondary conductors are suitably protected from physical damage.

(D) SERVICE CONDUCTORS

Service-entrance conductors shall be permitted to be protected by overcurrent devices in accordance with 230.91.

(E) BUSWAY TAPS

Busways and busway taps shall be permitted to be protected against overcurrent in accordance with 368.10 through 368.13.

(F) MOTOR CIRCUIT TAPS

Motor-feeder and branch-circuit conductors shall be permitted to be protected against overcurrent in accordance with 430.28 and 430.53, respectively.

(G) CONDUCTORS FROM GENERATOR TERMINALS

Conductors from generator terminals that meet the size requirement in 445.13 shall be permitted to be protected against overload by the generator overload protective device(s) required by 445.12.

2.4 NEC ARTICLE 310: CONDUCTORS FOR GENERAL WIRING

Introduction

This article covers conductors for general wiring and includes Articles 310.1 through 310.60. Only Articles 310.3, 310.4, 310.5, 310.13, and 310.15 are included here in their entirety. The user of this handbook is encouraged to refer to the NEC for the complete text of the *Code*.

310.3. Stranded Conductors

Where installed in raceways, conductors of size 8 AWG and larger shall be stranded.

Exception: As permitted or required elsewhere in this *Code*.

310.4. Conductors in Parallel

Aluminum, copper-clad aluminum, or copper conductors of size 1/0 AWG and larger, comprising each phase, neutral, or grounded circuit conductor, shall be permitted to be connected in parallel (electrically joined at both ends to form a single conductor).

Exception No. 1: As permitted in 620.12(A)(1).

Exception No. 2: Conductors in sizes smaller than 1/0 AWG shall be permitted to be run in parallel to supply control power to indicating instruments, contactors, relays, solenoids, and similar control devices provided (a) they are contained in the same raceway or cable; (b) the ampacity of each individual conductor is sufficient to

carry the entire load current shared by the parallel conductors; and (c) the overcurrent protection is such that the ampacity of each individual conductor will not be exceeded if one or more of the parallel conductors becomes inadvertently disconnected.

Exception No. 3: Conductors in sizes smaller than 1/0 AWG shall be permitted to be run in parallel for frequencies of 360 hertz and higher where conditions (a), (b), and (c) of Exception No. 2 are met.

Exception No. 4: Under engineering supervision, grounded neutral conductors in sizes 2 AWG and larger shall be permitted to be run in parallel for existing installations.

NOTE Exception No. 4 can be used to alleviate overheating of neutral conductors in existing installations due to high content of triplen harmonic currents.

The paralleled conductors in each phase, neutral, or grounded circuit conductor shall

1. Be the same length
2. Have the same conductor material
3. Be the same size in circular mil area
4. Have the same insulation type
5. Be terminated in the same manner

Where run in separate raceways or cables, the raceways or cables shall have the same physical characteristics. Conductors of one phase, neutral, or grounded circuit conductor shall not be required to have the same physical characteristics as those of another phase, neutral, or grounded circuit conductor to achieve balance.

NOTE Differences in inductive reactance and unequal division of current can be minimized by choice of materials, methods of construction, and orientation of conductors.

Where equipment grounding conductors are used with conductors in parallel, they shall comply with the requirements of this section except that they shall be sized in accordance with Section 250.122.

Conductors installed in parallel shall comply with the provisions of 310.15(B)(2)(a).

310.5 Minimum Size of Conductors

The minimum size of conductors shall be as shown in Table 2.4 (NEC Table 310.5).

TABLE 2.4 NEC Table 310.5: Minimum Size of Conductors

Conductor Voltage Rating (Volts)	Minimum Conductor Size (AWG)	
	Copper	Aluminum or Copper-Clad Aluminum
0–2000	14	12
2001–8000	8	8
8001–15,000	2	2
15,001–28,000	1	1
28,001–35,000	1/0	1/0

Exception No. 1: For flexible cords as permitted by 400.12.

Exception No. 2: For fixture wire as permitted by 402.6.

Exception No. 3: For motors rated 1 horsepower or less as permitted by 430.22(F).

Exception No. 4: For cranes and hoists as permitted by 610.14.

Exception No. 5: For elevator control and signaling circuits as permitted by 620.12.

Exception No. 6: For Class 1, Class 2, and Class 3 circuits as permitted by 725.27(A) and 725.51, Exception.

Exception No. 7: Fire alarm circuits as permitted by 760.27(A), 760.51, Exception, and 760.71(B).

Exception No. 8: For motor-control circuits as permitted by 430.72.

Exception No. 9: For control and instrumentation circuits as permitted by 727.6.

Exception No. 10: For electric signs and outline lighting as permitted in 600.31(B) and 600.32(B).

310.13 Conductor Constructions and Applications

Insulated conductors shall comply with the applicable provisions of one or more of the following: Tables 310.13, 310.61, 310.62, 310.63, and 310.64.

These conductors shall be permitted for use in any of the wiring methods recognized in Chap. 3 and as specified in their respective tables.

NOTE Thermoplastic insulation may stiffen at temperatures colder than -10°C ($+14^{\circ}\text{F}$). Thermoplastic insulation may also be deformed at

normal temperatures where subjected to pressure, such as at points of support. Thermoplastic insulation, where used on DC circuits in wet locations, may result in electroendosmosis between conductor and insulation.

Table 2.5, which is not a part of the NEC, but is a part of the *NEC Handbook*, is included for your convenience:

For Conductor Applications and Insulations, see Table 2.6 (NEC Table 310.13).

310.15 Ampacities for Conductors Rated 0–2000 Volts

(A) GENERAL

(1) TABLES OR ENGINEERING SUPERVISION

Ampacities for conductors shall be permitted to be determined by tables or under engineering supervision, as provided in 310.15(B) and (C).

NOTE No. 1: Ampacities provided by this section do not take voltage drop into consideration. See 210.19(A), FPN No. 4, for branch circuits and Section 215.2(D), FPN No. 2, for feeders. FPN No. 2: For allowable ampacities of Type MTW wire, see Table 11 in NFPA 79-1977, *Electrical Standard for Industrial Machinery*.

(2) SELECTION OF AMPACITY

Where more than one calculated or tabulated ampacity could apply for a given circuit length, the lowest value shall be used.

Exception: Where two different ampacities apply to adjacent portions of a circuit, the higher ampacity shall be permitted to be used beyond the point of transition, a distance equal to 3.0 m (10 ft) or 10 percent of the circuit length figured at the higher ampacity, whichever is less.

NOTE See Section 110.14(C) for conductor temperature limitations due to termination provisions.

(B) TABLES

Ampacities for conductors rated 0 to 2000 volts shall be as specified in the Allowable Ampacity Table 310.16 through Table 310.19 and Ampacity Table 310.20 through 310.23 as modified by (1) through (6).

TABLE 2.5 Conductor Characteristics

Characteristic	Copper	Copper-Clad Aluminum	Aluminum
Density (lb/in. ³)	0.323	0.121	0.098
Density (g/cm ³)	8.91	3.34	2.71
Resistivity ohms/CMF	10.37	16.08	16.78
Resistivity Microhm — CM	1.724	2.673	2.790
Conductivity (IACS %)	100	61–63	61.0
Weight % Copper	100	26.8	—
Tensile K psi — Hard	65.0	30.0	27.0
Tensile kg/mm ² — Hard	45.7	21.1	19.0
Tensile K psi — Annealed	35.0	17.0	17.0*
Tensile kg/mm ² — Annealed	24.6	12.0	12.0
Specific Gravity	8.91	3.34	2.71

*Semi-annealed

TABLE 2.6 NEC Table 310.13: Conductor Application and Insulations

Trade Name	Type Letter	Maximum Operating Temperature	Application Provisions	Insulation	Thickness of Insulation				Outer Covering ¹	
					AWG or kcmil	mm		Mils		
Fluorinated ethylene propylene	FEP or FEPB	90°C 194°F	Dry and damp locations	Fluorinated ethylene propylene	14–10 8–2	0.51 0.76		20 30	None	
		200°C 392°F	Dry locations — special applications ²	Fluorinated ethylene propylene	14–8	0.36		14	Glass braid	
					6–2	0.36		14	Glass or other suitable braid material	
Mineral insulation (metal sheathed)	MI	90°C 194°F	Dry and wet locations	Magnesium oxide	18–16 ³ 16–10	0.58 0.91		23 36	Copper or alloy steel	
		250°C 482°F	For special applications ²		9–4	1.27		50		
					3–500	1.40		55		
Moisture-, heat-, and oil-resistant thermoplastic	MTW	60°C 140°F	Machine tool wiring in wet locations as permitted in NFPA 79 (See Article 670.) Machine tool wiring in dry locations as permitted in NFPA 79 (See Article 670.)	Flame-retardant moisture-, heat-, and oil-resistant thermoplastic	22–12 10 8 6 4–2 1–4/0 213–500 501–1000	(A)	(B)	(A)	(B)	(A) None (B) Nylon jacket or equivalent
		0.76				0.38	30	15		
		0.76				0.51	30	20		
		1.14				0.76	45	30		
		1.52				0.76	60	30		
		1.52				1.02	60	40		
		2.03				1.27	80	50		
2.41	1.52	95	60							
2.79	1.78	110	70							
Paper		85°C 185°F	For underground service conductors, or by special permission	Paper					Lead sheath	
Perfluoroalkoxy	PFA	90°C 194°F	Dry and damp locations	Perfluoroalkoxy	14–10 8–2 1–4/0	0.51 0.76 1.14		20 30 45	None	
		200°C 392°F	Dry locations — special applications ²							

(continued)

TABLE 2.6 NEC Table 310.13: Conductor Application and Insulations (*Continued*)

Trade Name	Type Letter	Maximum Operating Temperature	Application Provisions	Insulation	Thickness of Insulation			Outer Covering ¹
					AWG or kcmil	mm	Mils	
Perfluoro-alkoxy	PFAH	250°C 482°F	Dry locations only. Only for leads within apparatus or within raceways connected to apparatus (nickel or nickel-coated copper only)	Perfluoro-alkoxy	14-10	0.51	20	None
					8-2	0.76	30	
					1-4/0	1.14	45	
Thermoset	RHH	90°C 194°F	Dry and damp locations		14-10	1.14	45	Moisture-resistant, flame-retardant, nonmetallic covering ¹
					8-2	1.52	60	
					1-4/0	2.03	80	
					213-500	2.41	95	
					501-1000	2.79	110	
					1001-2000	3.18	125	
					For 601-2000, see Table 310.62.			
Moisture-resistant thermoset	RHW ⁴	75°C 167°F	Dry and wet locations	Flame-retardant, moisture-resistant thermoset	14-10	1.14	45	Moisture-resistant, flame-retardant, nonmetallic covering ⁵
					8-2	1.52	60	
					1-4/0	2.03	80	
					213-500	2.41	95	
					501-1000	2.79	110	
					1001-2000	3.18	125	
					For 601-2000, see Table 310.62.			
Moisture-resistant thermoset	RHW-2	90°C 194°F	Dry and wet locations	Flame-retardant moisture-resistant thermoset	14-10	1.14	45	Moisture-resistant, flame-retardant, nonmetallic covering ⁵
					8-2	1.52	60	
					1-4/0	2.03	80	
					213-500	2.41	95	
					501-1000	2.79	110	
					1001-2000	3.18	125	
					For 601-2000, see Table 310.62.			
Silicone	SA	90°C 194°F	Dry and damp locations		14-10	1.14	45	Glass or other suitable braid material
					8-2	1.52	60	
					1-4/0	2.03	80	
		200°C 392°F	For special application ²	Silicone rubber	213-500	2.41	95	
					501-1000	3.18	110	
					1001-2000	3.18	125	
Thermoset	SIS	90°C 194°F	Switchboard wiring only	Flame-retardant thermoset	14-10	0.76	30	None
					8-2	1.14	45	
					1-4/0	2.41	95	

(continued)

TABLE 2.6 NEC Table 310.13: Conductor Application and Insulations (*Continued*)

Trade Name	Type Letter	Maximum Operating Temperature	Application Provisions	Insulation	Thickness of Insulation			Outer Covering ¹
					AWG or kcmil	mm	Mils	
Thermoplastic and fibrous outer braid	TBS	90°C 194°F	Switchboard wiring only	Thermoplastic	14-10	0.76	30	Flame-retardant, nonmetallic covering
					8	1.14	45	
					6-2	1.52	60	
					1-4/0	2.03	80	
Extended polytetrafluoroethylene	TFE	250°C 482°F	Dry locations only. Only for leads within apparatus or within raceways connected to apparatus, or as open wiring (nickel or nickel-coated copper only)	Extruded polytetrafluoroethylene	14-10	0.51	20	None
					8-2	0.76	30	
					1-4/0	1.14	45	
Heatresistant thermoplastic	THHN	90°C 194°F	Dry and damp locations	Flame-retardant, heat-resistant thermoplastic	14-12	0.38	15	Nylon jacket or equivalent
					10	0.51	20	
					8-6	0.76	30	
					4-2	1.02	40	
					1-4/0	1.27	50	
					250-500	1.52	60	
					501-1000	1.78	70	
Moisture- and heat-resistant thermoplastic	THHW	75°C 167°F 90°C 194°F	Wet location Dry location	Flame-retardant, moisture- and heat-resistant thermoplastic	14-10	0.76	30	None
					8	1.14	45	
					6-2	1.52	60	
					1-4/0	2.03	80	
					213-500	2.41	95	
					501-1000	2.79	110	
Moisture- and heat-resistant thermoplastic	THW ⁴	75°C 167°F	Dry and wet locations	Flame-retardant, moisture- and heat-resistant thermoplastic	14-10	0.76	30	None
					8	1.14	45	
					6-2	1.52	60	
					1-4/0	2.03	80	
					213-500	2.41	95	
		90°C 194°F	Special applications within electric discharge lighting equipment. Limited to 1000 open-circuit volts or less. (size 14-8 only as permitted in 410.33)	501-1000	2.79	110		
				1001-2000	3.18	125		
Moisture- and heat-resistant thermoplastic	THWN ⁴	75°C 167°F	Dry and wet locations	Flame-retardant, moisture- and heat-resistant thermoplastic	14-12	0.38	15	Nylon jacket or equivalent
					10	0.51	20	
					8-6	0.76	30	
					4-2	1.02	40	
					1-4/0	1.27	50	
					250-500	1.52	60	
					501-1000	1.78	70	

(continued)

TABLE 2.6 NEC Table 310.13: Conductor Application and Insulations (*Continued*)

Trade Name	Type Letter	Maximum Operating Temperature	Application Provisions	Insulation	Thickness of Insulation			Outer Covering ¹
					AWG or kcmil	mm	Mils	
Moisture-resistant thermoplastic	TW	60°C 140°F	Dry and wet locations	Flame-retardant, moisture-resistant thermoplastic	14-10	0.76	30	None
					8	1.14	45	
					6-2	1.52	60	
					1-4/0	2.03	80	
					213-500	2.41	95	
					501-1000	2.79	110	
1001-2000	3.18	125						
Underground feeder and branch-circuit cable — single conductor (For Type UF cable employing more than one conductor, see Articles 339, 340.)	UF	60°C 140°F 75°C 167°F ⁷	See Article 340.	Moisture-resistant	14-10	1.52	60 ⁶	Integral with insulation
					8-2	2.03	80 ⁶	
				Moisture- and heat-resistant	1-4/0	2.41	95 ⁶	
Underground service-entrance cable — single conductor (For Type USE cable employing more than one conductor, see Article 338.)	USE ⁴	75°C 167°F	See Article 338.	Heat- and moisture-resistant	14-10	1.14	45	Moisture-resistant nonmetallic covering (See 338.2.)
					8-2	1.52	60	
					1-4/0	2.03	80	
					213-500	2.41	95 ⁸	
					501-1000	2.79	110	
					1001-2000	3.18	125	
Thermoset	XHH	90°C 194°F	Dry and damp locations	Flame-retardant thermoset	14-10	0.76	30	None
					8-2	1.14	45	
					1-4/0	1.40	55	
					213-500	1.65	65	
					501-1000	2.03	80	
					1001-2000	2.41	95	
Moisture-resistant thermoset	XHHW ⁴	90°C 194°F	Dry and damp locations	Flame-retardant, moisture-resistant thermoset	14-10	0.76	30	None
					8-2	1.14	45	
					1-4/0	1.40	55	
		75°C 167°F	Wet locations	213-500	1.65	65		
				501-1000	2.03	80		
				1001-2000	2.41	95		

(continued)

TABLE 2.6 NEC Table 310.13: Conductor Application and Insulations (*Continued*)

Trade Name	Type Letter	Maximum Operating Temperature	Application Provisions	Insulation	Thickness of Insulation			Outer Covering ¹		
					AWG or kcmil	mm	Mils			
Moisture-resistant thermoset	XHHW-2	90°C 194°F	Dry and wet locations	Flame-retardant, moisture-resistant thermoset	14–10	0.76	30	None		
					8–2	1.14	45			
					1–4/0	1.40	55			
					213–500	1.65	65			
					501–1000	2.03	80			
					1001–2000	2.41	95			
Modified ethylene tetrafluoroethylene	Z	90°C 194°F	Dry and damp locations	Modified ethylene tetrafluoroethylene	14–12	0.38	15	None		
					10	0.51	20			
		150°C 302°F	Dry locations — special applications ²		8–4	0.64	25			
					3–1	0.89	35			
					1/0–4/0	1.14	45			
Modified ethylene tetrafluoroethylene	ZW ⁴	75°C 167°F	Wet locations	Modified ethylene tetrafluoroethylene	14–10	0.76	30	None		
					8–2	1.14	45			
		90°C 194°F	Dry and damp locations		150°C 302°F	Dry locations — special applications ²				

¹ Some insulations do not require an outer covering.

² Where design conditions require maximum conductor operating temperatures above 90°C (194°F).

³ For signaling circuits permitting 300-volt insulation.

⁴ Listed wire types designated with the suffix “2,” such as RHW-2, shall be permitted to be used at a continuous 90°C (194°F) operating temperature, wet or dry.

⁵ Some rubber insulations do not require an outer covering.

⁶ Includes integral jacket.

⁷ For ampacity limitation, see 340.80.

⁸ Insulation thickness shall be permitted to be 2.03 mm (80 mils) for listed Type USE conductors that have been subjected to special investigations. The nonmetallic covering over individual rubber-covered conductors of aluminum-sheathed cable and of lead-sheathed or multiconductor cable shall not be required to be flame retardant. For Type MC cable, see 330.104. For nonmetallic-sheathed cable, see Article 334, Part III. For Type UF cable, see Article 340, Part III.

NOTE Tables 2.7 through 2.10 (NEC Tables 310.16 through 310.19) are application tables for determining conductor sizes on loads calculated in accordance with Article 220. Allowable ampacities result from consideration of one or more of the following:

1. Temperature compatibility with connected equipment, especially at the connection points.
2. Coordination with circuit and system overcurrent protection.
3. Compliance with the requirements of product listings or certifications. See 110.3(B).
4. Preservation of the safety benefits of established industry practices and standardized procedures.

(1) GENERAL

For explanation of type letters used in tables and for recognized sizes of conductors for the various conductor insulations, see 310.13. For installation requirements, see 310.1 through 310.10 and the various articles of this *Code*. For flexible cords, see Tables 400.4, 400.5(A), and 400.5(B).

(2) ADJUSTMENT FACTORS

(a) More than three current-carrying conductors in a raceway or cable. Where the number of current-carrying conductors in a raceway or cable exceeds three, or where single conductors or multiconductor cables are stacked or bundled longer than 600 mm (24 in.) without maintaining spacing and are not installed in raceways, the allowable ampacity of each conductor shall be reduced as shown in Table 2.11 [NEC Table 310.15(B)(2)(a)].

Exception No. 1: Where conductors of different systems, as provided in 300.3, are installed in a common raceway or cable, the derating factors shown in Table 2.12 [NEC Table 310.15(B)(2)(a)] shall apply to the number of power and lighting conductors only (Articles 210, 215, 220, and 230).

Exception No. 2: For conductors installed in cable trays, the provisions of 392.11 shall apply.

Exception No. 3: Derating factors shall not apply to conductors in nipples having a length not exceeding 600 mm (24 in.).

Exception No. 4: Derating factors shall not apply to underground conductors entering or leaving an outdoor trench if those conductors have physical protection in the form of rigid metal conduit, intermediate metal conduit, or rigid nonmetallic conduit having a length not exceeding 3.05 m (10 ft) and the number of conductors does not exceed four.

TABLE 2.7 NEC Table 310.16: Allowable ampacities of insulated conductors rated 0 through 2000 V, 60°C through 90°C (140°F through 194°F) not more than three current-carrying conductors in a raceway, cable, or earth (directly buried), based on ambient air temperature of 30°C (86°F)

Size AWG or kcmil		Temperature Rating of Conductor (See Table 310.13.)						Size AWG or kcmil
		60°C (140°F)	75°C (167°F)	90°C (194°F)	60°C (140°F)	75°C (167°F)	90°C (194°F)	
		Types TW, UF	Types RHW, THHW, THW, THWN, XHHW, USE, ZW	Types TBS, SA, SIS, FEP, FEPB, MI, RHH, RHW-2, THHN, THHW, THW-2, THWN-2, USE-2, XHH, XHHW, XHHW-2, ZW-2	Types TW, UF	Types RHW, THHW, THW, THWN, XHHW, USE	Types TBS, SA, SIS, THHN, THHW, THW-2, THWN-2, RHH, RHW-2, USE-2, XHH, XHHW, XHHW-2, ZW-2	
COPPER				ALUMINUM OR COPPER-CLAD ALUMINUM				
18	—	—	14	—	—	—	—	
16	—	—	18	—	—	—	—	
14*	20	20	25	—	—	—	—	
12*	25	25	30	20	20	25	12*	
10*	30	35	40	25	30	35	10*	
8	40	50	55	30	40	45	8	
6	55	65	75	40	50	60	6	
4	70	85	95	55	65	75	4	
3	85	100	110	65	75	85	3	
2	95	115	130	75	90	100	2	
1	110	130	150	85	100	115	1	
1/0	125	150	170	100	120	135	1/0	
2/0	145	175	195	115	135	150	2/0	
3/0	165	200	225	130	155	175	3/0	
4/0	195	230	260	150	180	205	4/0	
250	215	255	290	170	205	230	250	
300	240	285	320	190	230	255	300	
350	260	310	350	210	250	280	350	
400	280	335	380	225	270	305	400	
500	320	380	430	260	310	350	500	
600	355	420	475	285	340	385	600	
700	385	460	520	310	375	420	700	
750	400	475	535	320	385	435	750	
800	410	490	555	330	395	450	800	
900	435	520	585	355	425	480	900	
1000	455	545	615	375	445	500	1000	
1250	495	590	665	405	485	545	1250	
1500	520	625	705	435	520	585	1500	
1750	545	650	735	455	545	615	1750	
2000	560	665	750	470	560	630	2000	

CORRECTION FACTORS

Ambient Temp. (°C)	For ambient temperatures other than 30°C (86°F), multiply the allowable ampacities shown above by the appropriate factor shown below.						Ambient Temp. (°F)
21–25	1.08	1.05	1.04	1.08	1.05	1.04	70–77
26–30	1.00	1.00	1.00	1.00	1.00	1.00	78–86
31–35	0.91	0.94	0.96	0.91	0.94	0.96	87–95
36–40	0.82	0.88	0.91	0.82	0.88	0.91	96–104
41–45	0.71	0.82	0.87	0.71	0.82	0.87	105–113
46–50	0.58	0.75	0.82	0.58	0.75	0.82	114–122
51–55	0.41	0.67	0.76	0.41	0.67	0.76	123–131
56–60	—	0.58	0.71	—	0.58	0.71	132–140
61–70	—	0.33	0.58	—	0.33	0.58	141–158
71–80	—	—	0.41	—	—	0.41	159–176

* See 240.4(D).

(© 2001, NFPA)

TABLE 2.8 NEC Table 310.17: Allowable ampacities of single-insulated conductors rated 0 through 2000 V in free air, based on ambient air temperature of 30°C (86°F)

Size AWG or kcmil	Temperature Rating of Conductor (See Table 310.13.)						Size AWG or kcmil
	60°C (140°F)	75°C (167°F)	90°C (194°F)	60°C (140°F)	75°C (167°F)	90°C (194°F)	
	Types TW, UF	Types RHW, THHW, THW, THWN, XHHW, ZW	Types TBS, SA, SIS, FEP, FEPB, MI, RHH, RHW-2, THHN, THHW, THW-2, THWN-2, USE-2, XHH, XHHW, XHHW-2, ZW-2	Types TW, UF	Types RHW, THHW, THW, THWN, XHHW	Types TBS, SA, SIS, THHN, THHW, THW-2, THWN-2, RHH, RHW-2, USE-2, XHH, XHHW, XHHW-2, ZW-2	
	COPPER			ALUMINUM OR COPPER-CLAD ALUMINUM			
18	—	—	18	—	—	—	—
16	—	—	24	—	—	—	—
14*	25	30	35	—	—	—	—
12*	30	35	40	25	30	35	12*
10*	40	50	55	35	40	40	10*
8	60	70	80	45	55	60	8
6	80	95	105	60	75	80	6
4	105	125	140	80	100	110	4
3	120	145	165	95	115	130	3
2	140	170	190	110	135	150	2
1	165	195	220	130	155	175	1
1/0	195	230	260	150	180	205	1/0
2/0	225	265	300	175	210	235	2/0
3/0	260	310	350	200	240	275	3/0
4/0	300	360	405	235	280	315	4/0
250	340	405	455	265	315	355	250
300	375	445	505	290	350	395	300
350	420	505	570	330	395	445	350
400	455	545	615	355	425	480	400
500	515	620	700	405	485	545	500
600	575	690	780	455	540	615	600
700	630	755	855	500	595	675	700
750	655	785	885	515	620	700	750
800	680	815	920	535	645	725	800
900	730	870	985	580	700	785	900
1000	780	935	1055	625	750	845	1000
1250	890	1065	1200	710	855	960	1250
1500	980	1175	1325	795	950	1075	1500
1750	1070	1280	1445	875	1050	1185	1750
2000	1155	1385	1560	960	1150	1335	2000

(continued)

TABLE 2.8 NEC Table 310.17: Allowable ampacities of single-insulated conductors rated 0 through 2000 V in free air, based on ambient air temperature of 30°C (86°F)
(Continued)

		Temperature Rating of Conductor (See Table 310.13.)							
		60°C (140°F)	75°C (167°F)	90°C (194°F)	60°C (140°F)	75°C (167°F)	90°C (194°F)		
Size AWG or kcmil		Types TW, UF	Types RHW, THHW, THW, THWN, XHHW, ZW	Types TBS, SA, SIS, FEP, FEPB, MI, RHH, RHW-2, THHN, THHW, THW-2, THWN-2, USE-2, XHH, XHHW, XHHW-2, ZW-2	Types TW, UF	Types RHW, THHW, THW, THWN, XHHW	Types TBS, SA, SIS, THHN, THHW, THW-2, THWN-2, RHH, RHW-2, USE-2, XHH, XHHW, XHHW-2, ZW-2	Size AWG or kcmil	

CORRECTION FACTORS

Ambient Temp. (°C)	For ambient temperatures other than 30°C (86°F), multiply the allowable ampacities shown above by the appropriate factor shown below.						Ambient Temp. (°F)
	21-25	1.08	1.05	1.04	1.08	1.05	
26-30	1.00	1.00	1.00	1.00	1.00	1.00	78-86
31-35	0.91	0.94	0.96	0.91	0.94	0.96	87-95
36-40	0.82	0.88	0.91	0.82	0.88	0.91	96-104
41-45	0.71	0.82	0.87	0.71	0.82	0.87	105-113
46-50	0.58	0.75	0.82	0.58	0.75	0.82	114-122
51-55	0.41	0.67	0.76	0.41	0.67	0.76	123-131
56-60	—	0.58	0.71	—	0.58	0.71	132-140
61-70	—	0.33	0.58	—	0.33	0.58	141-158
71-80	—	—	0.41	—	—	0.41	159-176

* See 240.4(D).

(© 2001, NFPA)

TABLE 2.9 NEC Table 310.18: Allowable ampacities of insulated conductors, rated 0 through 2000 V, 150°C through 250°C (302°F through 482°F), in raceway or cable, based on ambient air temperature of 40°C (104°F)

Size AWG or kcmil	Temperature Rating of Conductor (See Table 310.13.)				Size AWG or kcmil
	150°C (302°F)	200°C (392°F)	250°C (482°F)	150°C (302°F)	
	Type Z	Types FEP, FEPB, PFA	Types PFAH, TFE	Type Z	
	COPPER		NICKEL OR NICKEL-COATED COPPER	ALUMINUM OR COPPER-CLAD ALUMINUM	
14	34	36	39	—	14
12	43	45	54	30	12
10	55	60	73	44	10
8	76	83	93	57	8
6	96	110	117	75	6
4	120	125	148	94	4
3	143	152	166	109	3
2	160	171	191	124	2
1	186	197	215	145	1
1/0	215	229	244	169	1/0
2/0	251	260	273	198	2/0
3/0	288	297	308	227	3/0
4/0	332	346	361	260	4/0

CORRECTION FACTORS

Ambient Temp. (°C)	For ambient temperatures other than 40°C (104°F), multiply the allowable ampacities shown above by the appropriate factor shown below.				Ambient Temp. (°F)
41–50	0.95	0.97	0.98	0.95	105–122
51–60	0.90	0.94	0.95	0.90	123–140
61–70	0.85	0.90	0.93	0.85	141–158
71–80	0.80	0.87	0.90	0.80	159–176
81–90	0.74	0.83	0.87	0.74	177–194
91–100	0.67	0.79	0.85	0.67	195–212
101–120	0.52	0.71	0.79	0.52	213–248
121–140	0.30	0.61	0.72	0.30	249–284
141–160	—	0.50	0.65	—	285–320
161–180	—	0.35	0.58	—	321–356
181–200	—	—	0.49	—	357–392
201–225	—	—	0.35	—	393–437

(© 2001, NFPA)

TABLE 2.10 NEC Table 310.19: Allowable ampacities of single-insulated conductors, rated 0 through 2000 V, 150°C through 250°C (302°F through 482°F), in free air, based on ambient air temperature of 40°C (104°F)

Size AWG or kcmil	Temperature Rating of Conductor (See Table 310.13.)				Size AWG or kcmil
	150°C (302°F)	200°C (392°F)	250°C (482°F)	150°C (302°F)	
	Type Z	Types FEP, FEPB, PFA	Types PFAH, TFE	Type Z	
	COPPER		NICKEL, OR NICKEL-COATED COPPER	ALUMINUM OR COPPER-CLAD ALUMINUM	
14	46	54	59	—	14
12	60	68	78	47	12
10	80	90	107	63	10
8	106	124	142	83	8
6	155	165	205	112	6
4	190	220	278	148	4
3	214	252	327	170	3
2	255	293	381	198	2
1	293	344	440	228	1
1/0	339	399	532	263	1/0
2/0	390	467	591	305	2/0
3/0	451	546	708	351	3/0
4/0	529	629	830	411	4/0

CORRECTION FACTORS

Ambient Temp. (°C)	For ambient temperatures other than 40°C (104°F), multiply the allowable ampacities shown above by the appropriate factor shown below.				Ambient Temp. (°F)
41–50	0.95	0.97	0.98	0.95	105–122
51–60	0.90	0.94	0.95	0.90	123–140
61–70	0.85	0.90	0.93	0.85	141–158
71–80	0.80	0.87	0.90	0.80	159–176
81–90	0.74	0.83	0.87	0.74	177–194
91–100	0.67	0.79	0.85	0.67	195–212
101–120	0.52	0.71	0.79	0.52	213–248
121–140	0.30	0.61	0.72	0.30	249–284
141–160	—	0.50	0.65	—	285–320
161–180	—	0.35	0.58	—	321–356
181–200	—	—	0.49	—	357–392
201–225	—	—	0.35	—	393–437

(© 2001, NFPA)

TABLE 2.11 NEC Table 310.15(B)(2)(a) Adjustment Factors for More Than Three Current-Carrying Conductors in a Raceway or Cable

Number of Current-Carrying Conductors	Percent of Values in Tables 310.16 through 310.19 as Adjusted for Ambient Temperature if Necessary
4–6	80
7–9	70
10–20	50
21–30	45
31–40	40
41 and above	35

Exception No. 5: Adjustment factors shall not apply to Type AC cable or to Type MC cable without an overall outer jacket under the following conditions:

- (a) Each cable has not more than three current-carrying conductors.
- (b) The conductors are 12 AWG copper.
- (c) Not more than 20 current-carrying conductors are bundled, stacked, or supported on “bridle rings.”

(b) More than one conduit, tube, or raceway. Spacing between conduits, tubing, or raceways shall be maintained.

(3) BARE OR COVERED CONDUCTORS

Where bare or covered conductors are used with insulated conductors, their allowable ampacities shall be limited to those permitted for the adjacent insulated conductors.

(4) NEUTRAL CONDUCTOR

- (a) A neutral conductor that carries only the unbalanced current from other conductors of the same circuit shall not be required to be counted when applying the provisions of Table 2.11 [NEC Table 310.15(B)(2)(a)].
- (b) In a 3-wire circuit consisting of two phase wires and the neutral of a 4-wire, 3-phase wye-connected system, a common conductor carries approximately the same current as the line-to-neutral load

TABLE 2.12 NEC Table 310.15(B)(6) Conductor Types and Sizes for 120/240-Volt, 3-Wire, Single-Phase Dwelling Services and Feeders. Conductor Types RHH, RHW, RHW-2, THHN, THHW, THW, THW-2, THWN, THWN-2, XHHW, XHHW-2, SE, USE, USE-2

Conductor (AWG or kcmil)		
Copper	Aluminum or Copper-Clad Aluminum	Service or Feeder Rating (Amperes)
4	2	100
3	1	110
2	1/0	125
1	2/0	150
1/0	3/0	175
2/0	4/0	200
3/0	250	225
4/0	300	250
250	350	300
350	500	350
400	600	400

currents of the other conductors and shall be counted when applying the provisions of Table 2.11 [NEC Table 310.15(B)(2)(a)].

- (c) On a 4-wire, 3-phase wye circuit where the major portion of the load consists of nonlinear loads, harmonic currents are present in the neutral conductor; the neutral shall therefore be considered a current-carrying conductor.

(5) GROUNDING OR BONDING CONDUCTOR

A grounding or bonding conductor shall not be counted when applying the provisions of 310.15(B)(2)(a).

A 60 percent adjustment factor shall be applied where the current-carrying conductors in these cables that are stacked or bundled longer than 600 mm (24 in.) without maintaining spacing exceeds 20.

(6) 120/240-VOLT, 3-WIRE, SINGLE-PHASE DWELLING SERVICES AND FEEDERS

For dwelling units, conductors, as listed in Table 2.12 [NEC Table 310.15(B)(6)], shall be permitted as 120/240-volt, 3-wire, single-phase service-entrance conductors, service lateral conductors, and feeder conductors that serve as the main power feeder to a dwelling unit and are

installed in a raceway or cable with or without an equipment grounding conductor. For application of this section, the main power feeder shall be the feeder(s) between the main disconnect and the lighting and appliance branch-circuit panelboard(s). The feeder conductors to a dwelling unit shall not be required to be larger than their service-entrance conductors. The grounded conductor shall be permitted to be smaller than the ungrounded conductors, provided the requirements of 215.2, 220.22, and 230.42 are met.

(C) ENGINEERING SUPERVISION

Under engineering supervision, conductor ampacities shall be permitted to be calculated by means of the following general formula:

$$I = \sqrt{\frac{TC - (TA + \Delta TD)}{RDC(1 + YC)RCA}}$$

- Where:
- TC = Conductor in temperature °C
 - TA = Ambient temperature in °C
 - ΔTD = Dielectric loss temperature rise
 - RDC = DC resistance of a conductor at temperature TC
 - YC = Component ac resistance resulting from skin effect and proximity effect
 - RCA = Effective thermal resistance between conductor and surrounding ambient

NOTE See Appendix B for examples of formula applications

NOTE Tables 2.13 (NEC Table 310.61) and 2.14 (NEC Table 310.62) are included here for convenient reference. NEC Tables 310.63 through 310.86, which cover ampacities for conductors rated 2001 volts and higher, are not included in this handbook.

2.5 NEC CHAPTER 9 TABLES (PARTIAL)

Introduction

Included here are Tables 2.15 through 2.19, inclusive, which are NEC Chap. 9 Tables 1, 4, 5, 8, and 9, respectively. NEC Appendix C (partial) follows in Sec. 2.6.

TABLE 2.13 NEC Table 310.61: Conductor Application and Insulation

Trade Name	Type Letter	Maximum Operating Temperature	Application Provision	Insulation	Outer Covering
Medium voltage solid dielectric	MV-90 MV-105*	90°C 105°C	Dry or wet locations rated 2001 volts and higher	Thermoplastic or thermosetting	Jacket, sheath, or armor

*Where design conditions require maximum conductor temperatures above 90°C.

(© 2001, NFPA)

TABLE 2.14 NEC Table 310.62: Thickness of Insulation for 601- to 2000-V Nonshielded Types RHH and RHW

Conductor Size (AWG or kcmil)	Column A ¹		Column B ²	
	mm	mils	mm	mils
14-10	2.03	80	1.52	60
8	2.03	80	1.78	70
6-2	2.41	95	1.78	70
1-2/0	2.79	110	2.29	90
3/0-4/0	2.79	110	2.29	90
213-500	3.18	125	2.67	105
501-1000	3.56	140	3.05	120

¹Column A insulations are limited to natural, SBR, and butyl rubbers.

²Column B insulations are materials such as cross-linked polyethylene, ethylene propylene rubber, and composites thereof.

(© 2001, NFPA)

TABLE 2.15 NEC Chapter 9, Table 1: Percent of Cross Section of Conduit and Tubing for Conductors

Number of Conductors	All Conductor Types
1	53
2	31
Over 2	40

FPN No. 1: Table 1 is based on common conditions of proper cabling and alignment of conductors where the length of the pull and the number of bends are within reasonable limits. It should be recognized that, for certain conditions, a larger size conduit or a lesser conduit fill should be considered.

FPN No. 2: When pulling three conductors or cables into a raceway, if the ratio of the raceway (inside diameter) to the conductor or cable (outside diameter) is between 2.8 and 3.2, jamming can occur. While jamming can occur when pulling four or more conductors or cables into a raceway, the probability is very low.

(© 2001, NFPA)

Notes to Tables

Note 1: See Appendix C for the maximum number of conductors and fixture wires, all of the same size (total cross-sectional area including insulation), permitted in trade sizes of the applicable conduit or tubing.

Note 2: Table 1 applies only to complete conduit or tubing systems and is not intended to apply to sections of conduit or tubing used to protect exposed wiring from physical damage.

Note 3: Equipment grounding or bonding conductors, where installed, shall be included when calculating conduit or tubing fill. The actual dimensions of the equipment grounding or bonding conductor (insulated or bare) shall be used in the calculation.

Note 4: Where conduit or tubing nipples having a maximum length not to exceed 600 mm (24 in.) are installed between boxes, cabinets, and similar enclosures, the nipples shall be permitted to be filled to 60 percent of their total cross-sectional area, and 310.15(B)(2)(a) adjustment factors need not apply to this condition.

Note 5: For conductors not included in Chap. 9, such as multiconductor cables, the actual dimensions shall be used.

Note 6: For combinations of conductors of different sizes, use Table 5 and Table 5A for dimensions of conductors and Table 4 for the applicable conduit or tubing dimensions.

Note 7: When calculating the maximum number of conductors permitted in a conduit or tubing, all of the same size (total cross-sectional area including insulation), the next higher whole number shall be used to determine the maximum number of conductors permitted when the calculation results in a decimal of 0.8 or larger.

Note 8: Where bare conductors are permitted by other sections of this Code, the dimensions for bare conductors in Table 8 shall be permitted.

Note 9: A multiconductor cable of two or more conductors shall be treated as a single conductor for calculating percentage conduit fill area. For cables that have elliptical cross sections, the cross-sectional area calculation shall be based on using the major diameter of the ellipse as a circle diameter.

TABLE 2.16 NEC Chapter 9, Table 4: Dimensions and Percent Area of Conduit and Tubing (Areas of Conduit or Tubing for the Combinations of Wires Permitted in Table 1, Chap. 9)

Article 358 — Electrical Metallic Tubing (EMT)													
Metric Designator	Trade Size	Nominal Internal Diameter		Total Area 100%		2 Wires 31%		Over 2 Wires 40%		1 Wire 53%		60%	
		mm	in.	mm ²	in. ²	mm ²	in. ²	mm ²	in. ²	mm ²	in. ²	mm ²	in. ²
16	½	15.8	0.622	196	0.304	61	0.094	78	0.122	104	0.161	118	0.182
21	¾	20.9	0.824	343	0.533	106	0.165	137	0.213	182	0.283	206	0.320
27	1	26.6	1.049	556	0.864	172	0.268	222	0.346	295	0.458	333	0.519
35	1¼	35.1	1.380	968	1.496	300	0.464	387	0.598	513	0.793	581	0.897
41	1½	40.9	1.610	1314	2.036	407	0.631	526	0.814	696	1.079	788	1.221
53	2	52.5	2.067	2165	3.356	671	1.040	866	1.342	1147	1.778	1299	2.013
63	2½	69.4	2.731	3783	5.858	1173	1.816	1513	2.343	2005	3.105	2270	3.515
78	3	85.2	3.356	5701	8.846	1767	2.742	2280	3.538	3022	4.688	3421	5.307
91	3½	97.4	3.834	7451	11.545	2310	3.579	2980	4.618	3949	6.119	4471	6.927
103	4	110.1	4.334	9521	14.753	2951	4.573	3808	5.901	5046	7.819	5712	8.852

(continued)

TABLE 2.16 NEC Chapter 9, Table 4: Dimensions and Percent Area of Conduit and Tubing (Areas of Conduit or Tubing for the Combinations of Wires Permitted in Table 1, Chap. 9) (Continued)

Article 362 — Electrical Nonmetallic Tubing (ENT)													
Metric Designator	Trade Size	Nominal Internal Diameter		Total Area 100%		2 Wires 31%		Over 2 Wires 40%		1 Wire 53%		60%	
		mm	in.	mm ²	in. ²	mm ²	in. ²	mm ²	in. ²	mm ²	in. ²	mm ²	in. ²
16	½	14.2	0.560	158	0.246	49	0.076	63	0.099	84	0.131	95	0.148
21	¾	19.3	0.760	293	0.454	91	0.141	117	0.181	155	0.240	176	0.272
27	1	25.4	1.000	507	0.785	157	0.243	203	0.314	269	0.416	304	0.471
35	1¼	34.0	1.340	908	1.410	281	0.437	363	0.564	481	0.747	545	0.846
41	1½	39.9	1.570	1250	1.936	388	0.600	500	0.774	663	1.026	750	1.162
53	2	51.3	2.020	2067	3.205	641	0.993	827	1.282	1095	1.699	1240	1.923
63	2½	—	—	—	—	—	—	—	—	—	—	—	—
78	3	—	—	—	—	—	—	—	—	—	—	—	—
91	3½	—	—	—	—	—	—	—	—	—	—	—	—

Article 348 — Flexible Metal Conduit (FMT)													
Metric Designator	Trade Size	Nominal Internal Diameter		Total Area 100%		2 Wires 31%		Over 2 Wires 40%		1 Wire 53%		60%	
		mm	in.	mm ²	in. ²	mm ²	in. ²	mm ²	in. ²	mm ²	in. ²	mm ²	in. ²
12	¾	9.7	0.384	74	0.116	23	0.036	30	0.046	39	0.061	44	0.069
16	½	16.1	0.635	204	0.317	63	0.098	81	0.127	108	0.168	122	0.190
21	¾	20.9	0.824	343	0.533	106	0.165	137	0.213	182	0.283	206	0.320
27	1	25.9	1.020	527	0.817	163	0.253	211	0.327	279	0.433	316	0.490
35	1¼	32.4	1.275	824	1.277	256	0.396	330	0.511	437	0.677	495	0.766
41	1½	39.1	1.538	1201	1.858	372	0.576	480	0.743	636	0.985	720	1.115
53	2	51.8	2.040	2107	3.269	653	1.013	843	1.307	1117	1.732	1264	1.961
63	2½	63.5	2.500	3167	4.909	982	1.522	1267	1.963	1678	2.602	1900	2.945
78	3	76.2	3.000	4560	7.069	1414	2.191	1824	2.827	2417	3.746	2736	4.241
91	3½	88.9	3.500	6207	9.621	1924	2.983	2483	3.848	3290	5.099	3724	5.773
103	4	101.6	4.000	8107	12.566	2513	3.896	3243	5.027	4297	6.660	4864	7.540

Article 342 — Intermediate Metal Conduit (IMC)													
Metric Designator	Trade Size	Nominal Internal Diameter		Total Area 100%		2 Wires 31%		Over 2 Wires 40%		1 Wire 53%		60%	
		mm	in.	mm ²	in. ²	mm ²	in. ²	mm ²	in. ²	mm ²	in. ²	mm ²	in. ²
12	¾	—	—	—	—	—	—	—	—	—	—	—	—
16	½	16.8	0.660	222	0.342	69	0.106	89	0.137	117	0.181	133	0.205
21	¾	21.9	0.864	377	0.586	117	0.182	151	0.235	200	0.311	226	0.352
27	1	28.1	1.105	620	0.959	192	0.297	248	0.384	329	0.508	372	0.575
35	1¼	36.8	1.448	1064	1.647	330	0.510	425	0.659	564	0.873	638	0.988
41	1½	42.7	1.683	1432	2.225	444	0.690	573	0.890	759	1.179	859	1.335
53	2	54.6	2.150	2341	3.630	726	1.125	937	1.452	1241	1.924	1405	2.178
63	2½	64.9	2.557	3308	5.135	1026	1.592	1323	2.054	1753	2.722	1985	3.081
78	3	80.7	3.176	5115	7.922	1586	2.456	2046	3.169	2711	4.199	3069	4.753
91	3½	93.2	3.671	6822	10.584	2115	3.281	2729	4.234	3616	5.610	4093	6.351
103	4	105.4	4.166	8725	13.631	2705	4.226	3490	5.452	4624	7.224	5235	8.179

(continued)

TABLE 2.16 NEC Chapter 9, Table 4: Dimensions and Percent Area of Conduit and Tubing (Areas of Conduit or Tubing for the Combinations of Wires Permitted in Table 1, Chap. 9) (Continued)

Article 356— Liquidtight Flexible Nonmetallic Conduit (LFNC-B*)													
Metric Designator	Trade Size	Nominal Internal Diameter		Total Area 100%		2 Wires 31%		Over 2 Wires 40%		1 Wire 53%		60%	
		mm	in.	mm ²	in. ²	mm ²	in. ²	mm ²	in. ²	mm ²	in. ²	mm ²	in. ²
12	¾	12.5	0.494	123	0.192	38	0.059	49	0.077	65	0.102	74	0.115
16	½	16.1	0.632	204	0.314	63	0.097	81	0.125	108	0.166	122	0.188
21	¾	21.1	0.830	350	0.541	108	0.168	140	0.216	185	0.287	210	0.325
27	1	26.8	1.054	564	0.873	175	0.270	226	0.349	299	0.462	338	0.524
35	1¼	35.4	1.395	984	1.528	305	0.474	394	0.611	522	0.810	591	0.917
41	1½	40.3	1.588	1276	1.981	395	0.614	510	0.792	676	1.050	765	1.188
53	2	51.6	2.033	2091	3.246	648	1.006	836	1.298	1108	1.720	1255	1.948

*Corresponds to 356.2(2)

Article 356 — Liquidtight Flexible Nonmetallic Conduit (LFNC-A*)													
Metric Designator	Trade Size	Nominal Internal Diameter		Total Area 100%		2 Wires 31%		Over 2 Wires 40%		1 Wire 53%		60%	
		mm	in.	mm ²	in. ²	mm ²	in. ²	mm ²	in. ²	mm ²	in. ²	mm ²	in. ²
12	¾	12.6	0.495	125	0.192	39	0.060	50	0.077	66	0.102	75	0.115
16	½	16.0	0.630	201	0.312	62	0.097	80	0.125	107	0.165	121	0.187
21	¾	21.0	0.825	346	0.535	107	0.166	139	0.214	184	0.283	208	0.321
27	1	26.5	1.043	552	0.854	171	0.265	221	0.342	292	0.453	331	0.513
35	1¼	35.1	1.383	968	1.502	300	0.466	387	0.601	513	0.796	581	0.901
41	1½	40.7	1.603	1301	2.018	403	0.626	520	0.807	690	1.070	781	1.211
53	2	52.4	2.063	2157	3.343	669	1.036	863	1.337	1143	1.772	1294	2.006

*Corresponds to 356.2(1)

Article 350 — Liquidtight Flexible Metal Conduit (LFMC)													
Metric Designator	Trade Size	Nominal Internal Diameter		Total Area 100%		2 Wires 31%		Over 2 Wires 40%		1 Wire 53%		60%	
		mm	in.	mm ²	in. ²	mm ²	in. ²	mm ²	in. ²	mm ²	in. ²	mm ²	in. ²
12	¾	12.5	0.494	123	0.192	38	0.059	49	0.077	65	0.102	74	0.115
16	½	16.1	0.632	204	0.314	63	0.097	81	0.125	108	0.166	122	0.188
21	¾	21.1	0.830	350	0.541	108	0.168	140	0.216	185	0.287	210	0.325
27	1	26.8	1.054	564	0.873	175	0.270	226	0.349	299	0.462	338	0.524
35	1¼	35.4	1.395	984	1.528	305	0.474	394	0.611	522	0.810	591	0.917
41	1½	40.3	1.588	1276	1.981	395	0.614	510	0.792	676	1.050	765	1.188
53	2	51.6	2.033	2091	3.246	648	1.006	836	1.298	1108	1.720	1255	1.948
63	2½	63.3	2.493	3147	4.881	976	1.513	1259	1.953	1668	2.587	1888	2.929
78	3	78.4	3.085	4827	7.475	1497	2.317	1931	2.990	2559	3.962	2896	4.485
91	3½	89.4	3.520	6277	9.731	1946	3.017	2511	3.893	3327	5.158	3766	5.839
103	4	102.1	4.020	8187	12.692	2538	3.935	3275	5.077	4339	6.727	4912	7.615
129	5	—	—	—	—	—	—	—	—	—	—	—	—
155	6	—	—	—	—	—	—	—	—	—	—	—	—

(continued)

TABLE 2.16 NEC Chapter 9, Table 4: Dimensions and Percent Area of Conduit and Tubing (Areas of Conduit or Tubing for the Combinations of Wires Permitted in Table 1, Chap. 9) (Continued)

Article 344 — Rigid Metal Conduit (RMC)													
Metric Designator	Trade Size	Nominal Internal Diameter		Total Area 100%		2 Wires 31%		Over 2 Wires 40%		1 Wire 53%		60%	
		mm	in.	mm ²	in. ²	mm ²	in. ²	mm ²	in. ²	mm ²	in. ²	mm ²	in. ²
12	¾	—	—	—	—	—	—	—	—	—	—	—	—
16	½	16.1	0.632	204	0.314	63	0.097	81	0.125	108	0.166	122	0.188
21	¾	21.2	0.836	353	0.549	109	0.170	141	0.220	187	0.291	212	0.329
27	1	27.0	1.063	573	0.887	177	0.275	229	0.355	303	0.470	344	0.532
35	1¼	35.4	1.394	984	1.526	305	0.473	394	0.610	522	0.809	591	0.916
41	1½	41.2	1.624	1333	2.071	413	0.642	533	0.829	707	1.098	800	1.243
53	2	52.9	2.083	2198	3.408	681	1.056	879	1.363	1165	1.806	1319	2.045
63	2½	63.2	2.489	3137	4.866	972	1.508	1255	1.946	1663	2.579	1882	2.919
78	3	78.5	3.090	4840	7.499	1500	2.325	1936	3.000	2565	3.974	2904	4.499
91	3½	90.7	3.570	6461	10.010	2003	3.103	2584	4.004	3424	5.305	3877	6.006
103	4	102.9	4.050	8316	12.882	2578	3.994	3326	5.153	4408	6.828	4990	7.729
129	5	128.9	5.073	13050	20.212	4045	6.266	5220	8.085	6916	10.713	7830	12.127
155	6	154.8	6.093	18821	29.158	5834	9.039	7528	11.663	9975	15.454	11292	17.495

Article 352 — Rigid PVC Conduit (RNC), Schedule 80													
Metric Designator	Trade Size	Nominal Internal Diameter		Total Area 100%		2 Wires 31%		Over 2 Wires 40%		1 Wire 53%		60%	
		mm	in.	mm ²	in. ²	mm ²	in. ²	mm ²	in. ²	mm ²	in. ²	mm ²	in. ²
12	¾	—	—	—	—	—	—	—	—	—	—	—	—
16	½	13.4	0.526	141	0.217	44	0.067	56	0.087	75	0.115	85	0.130
21	¾	18.3	0.722	263	0.409	82	0.127	105	0.164	139	0.217	158	0.246
27	1	23.8	0.936	445	0.688	138	0.213	178	0.275	236	0.365	267	0.413
35	1¼	31.9	1.255	799	1.237	248	0.383	320	0.495	424	0.656	480	0.742
41	1½	37.5	1.476	1104	1.711	342	0.530	442	0.684	585	0.907	663	1.027
53	2	48.6	1.913	1855	2.874	575	0.891	742	1.150	983	1.523	1113	1.725
63	2½	58.2	2.290	2660	4.119	825	1.277	1064	1.647	1410	2.183	1596	2.471
78	3	72.7	2.864	4151	6.442	1287	1.997	1660	2.577	2200	3.414	2491	3.865
91	3½	84.5	3.326	5608	8.688	1738	2.693	2243	3.475	2972	4.605	3365	5.213
103	4	96.2	3.786	7268	11.258	2253	3.490	2907	4.503	3852	5.967	4361	6.755
129	5	121.1	4.768	11518	17.855	3571	5.535	4607	7.142	6105	9.463	6911	10.713
155	6	145.0	5.709	16513	25.598	5119	7.935	6605	10.239	8752	13.567	9908	15.359

Article 352 — Rigid PVC Conduit (RNC), Schedule 40, and HDPE Conduit													
Metric Designator	Trade Size	Nominal Internal Diameter		Total Area 100%		2 Wires 31%		Over 2 Wires 40%		1 Wire 53%		60%	
		mm	in.	mm ²	in. ²	mm ²	in. ²	mm ²	in. ²	mm ²	in. ²	mm ²	in. ²
12	¾	—	—	—	—	—	—	—	—	—	—	—	—
16	½	15.3	0.602	184	0.285	57	0.088	74	0.114	97	0.151	110	0.171
21	¾	20.4	0.804	327	0.508	101	0.157	131	0.203	173	0.269	196	0.305
27	1	26.1	1.029	535	0.832	166	0.258	214	0.333	284	0.441	321	0.499
35	1¼	34.5	1.360	935	1.453	290	0.450	374	0.581	495	0.770	561	0.872
41	1½	40.4	1.590	1282	1.986	397	0.616	513	0.794	679	1.052	769	1.191
53	2	52.0	2.047	2124	3.291	658	1.020	849	1.316	1126	1.744	1274	1.975

(continued)

TABLE 2.16 NEC Chapter 9, Table 4: Dimensions and Percent Area of Conduit and Tubing (Areas of Conduit or Tubing for the Combinations of Wires Permitted in Table 1, Chap. 9) (Continued)

Article 352 — Rigid PVC Conduit (RNC), Schedule 40, and HDPE Conduit													
Metric Designator	Trade Size	Nominal Internal Diameter		Total Area 100%		2 Wires 31%		Over 2 Wires 40%		1 Wire 53%		60%	
		mm	in.	mm ²	in. ²	mm ²	in. ²	mm ²	in. ²	mm ²	in. ²	mm ²	in. ²
63	2½	62.1	2.445	3029	4.695	939	1.455	1212	1.878	1605	2.488	1817	2.817
78	3	77.3	3.042	4693	7.268	1455	2.253	1877	2.907	2487	3.852	2816	4.361
91	3½	89.4	3.521	6277	9.737	1946	3.018	2511	3.895	3327	5.161	3766	5.842
103	4	101.5	3.998	8091	12.554	2508	3.892	3237	5.022	4288	6.654	4855	7.532
129	5	127.4	5.016	12748	19.761	3952	6.126	5099	7.904	6756	10.473	7649	11.856
155	6	153.2	6.031	18433	28.567	5714	8.856	7373	11.427	9770	15.141	11060	17.140

Article 352 — Type A, Rigid PVC Conduit (RNC)													
Metric Designator	Trade Size	Nominal Internal Diameter		Total Area 100%		2 Wires 31%		Over 2 Wires 40%		1 Wire 53%		60%	
		mm	in.	mm ²	in. ²	mm ²	in. ²	mm ²	in. ²	mm ²	in. ²	mm ²	in. ²
16	½	17.8	0.700	249	0.385	77	0.119	100	0.154	132	0.204	149	0.231
21	¾	23.1	0.910	419	0.650	130	0.202	168	0.260	222	0.345	251	0.390
27	1	29.8	1.175	697	1.084	216	0.336	279	0.434	370	0.575	418	0.651
35	1¼	38.1	1.500	1140	1.767	353	0.548	456	0.707	604	0.937	684	1.060
41	1½	43.7	1.720	1500	2.324	465	0.720	600	0.929	795	1.231	900	1.394
53	2	54.7	2.155	2350	3.647	728	1.131	940	1.459	1245	1.933	1410	2.188
63	2½	66.9	2.635	3515	5.453	1090	1.690	1406	2.181	1863	2.890	2109	3.272
78	3	82.0	3.230	5281	8.194	1637	2.540	2112	3.278	2799	4.343	3169	4.916
91	3½	93.7	3.690	6896	10.694	2138	3.315	2758	4.278	3655	5.668	4137	6.416
103	4	106.2	4.180	8858	13.723	2746	4.254	3543	5.489	4695	7.273	5315	8.234
129	5	—	—	—	—	—	—	—	—	—	—	—	—
155	6	—	—	—	—	—	—	—	—	—	—	—	—

Article 352 — Type EB, PVC Conduit (RNC)													
Metric Designator	Trade Size	Nominal Internal Diameter		Total Area 100%		2 Wires 31%		Over 2 Wires 40%		1 Wire 53%		60%	
		mm	in.	mm ²	in. ²	mm ²	in. ²	mm ²	in. ²	mm ²	in. ²	mm ²	in. ²
16	½	—	—	—	—	—	—	—	—	—	—	—	—
21	¾	—	—	—	—	—	—	—	—	—	—	—	—
27	1	—	—	—	—	—	—	—	—	—	—	—	—
35	1¼	—	—	—	—	—	—	—	—	—	—	—	—
41	1½	—	—	—	—	—	—	—	—	—	—	—	—
53	2	56.4	2.221	2498	3.874	774	1.201	999	1.550	1324	2.053	1499	2.325
63	2½	—	—	—	—	—	—	—	—	—	—	—	—
78	3	84.6	3.330	5621	8.709	1743	2.700	2248	3.484	2979	4.616	3373	5.226
91	3½	96.6	3.804	7329	11.365	2272	3.523	2932	4.546	3884	6.023	4397	6.819
103	4	108.9	4.289	9314	14.448	2887	4.479	3726	5.779	4937	7.657	5589	8.669
129	5	135.0	5.316	14314	22.195	4437	6.881	5726	8.878	7586	11.763	8588	13.317
155	6	160.9	6.336	20333	31.530	6303	9.774	8133	12.612	10776	16.711	12200	18.918

(© 2001, NFPA)

TABLE 2.17 NEC Chapter 9, Table 5: Dimensions of Insulated Conductors and Fixture Wires

Type	Size (AWG or kcmil)	Approximate Diameter		Approximate Area	
		mm	in.	mm ²	in. ²
Type: FFH-2, RFH-1, RFH-2, RHH*, RHW*, RHW-2*, RHH, RHW, RHW-2, SF-1, SF-2, SFF-1, SFF-2, TF, TFF, THHW, THW, THW-2, TW, XF, XFF					
RFH-2, FFH-2	18	3.454	0.136	9.355	0.0145
	16	3.759	0.148	11.10	0.0172
RHW-2, RHH, RHW	14	4.902	0.193	18.90	0.0293
	12	5.385	0.212	22.77	0.0353
	10	5.994	0.236	28.19	0.0437
	8	8.280	0.326	53.87	0.0835
	6	9.246	0.364	67.16	0.1041
	4	10.46	0.412	86.00	0.1333
	3	11.18	0.440	98.13	0.1521
	2	11.99	0.472	112.9	0.1750
	1	14.78	0.582	171.6	0.2660
	1/0	15.80	0.622	196.1	0.3039
	2/0	16.97	0.668	226.1	0.3505
	3/0	18.29	0.720	262.7	0.4072
	4/0	19.76	0.778	306.7	0.4754
	250	22.73	0.895	405.9	0.6291
	300	24.13	0.950	457.3	0.7088
	350	25.43	1.001	507.7	0.7870
	400	26.62	1.048	556.5	0.8626
	500	28.78	1.133	650.5	1.0082
	600	31.57	1.243	782.9	1.2135
	700	33.38	1.314	874.9	1.3561
	750	34.24	1.348	920.8	1.4272
	800	35.05	1.380	965.0	1.4957
	900	36.68	1.444	1057	1.6377
	1000	38.15	1.502	1143	1.7719
	1250	43.92	1.729	1515	2.3479
	1500	47.04	1.852	1738	2.6938
	1750	49.94	1.966	1959	3.0357
	2000	52.63	2.072	2175	3.3719
SP-2, SFF-2	18	3.073	0.121	7.419	0.0115
	16	3.378	0.133	8.968	0.0139
	14	3.759	0.148	11.10	0.0172
SF-1, SFF-1	18	2.311	0.091	4.194	0.0065
RFH-1, XF, XFF	18	2.692	0.106	5.161	0.0080
TF, TFF, XF, XFF	16	2.997	0.118	7.032	0.0109
TW, XF, XFF, THHW, THW, THW-2	14	3.378	0.133	8.968	0.0139
TW, THHW, THW, THW-2	12	3.861	0.152	11.68	0.0181
	10	4.470	0.176	15.68	0.0243
	8	5.994	0.236	28.19	0.0437
RHH*, RHW*, RHW-2*	14	4.140	0.163	13.48	0.0209
	12	4.623	0.182	16.77	0.0260

Type	Size (AWG or kcmil)	Approximate Diameter		Approximate Area	
		mm	in.	mm ²	in. ²
Type: RHH*, RHW*, RHW-2*, THHN, THHW, THW, THW-2, TFN, TFFN, THWN, THWN-2, XF, XFF					
THHW, THW, AF, XF, XFF	10	5.232	0.206	21.48	0.0333
RHH*, RHW*, RHW-2*	8	6.756	0.266	35.87	0.0556
TW, THW, THHW, THW, THW-2, RHH*, RHW*, RHW-2*	6	7.722	0.304	46.84	0.0726
	4	8.941	0.352	62.77	0.0973
	3	9.652	0.380	73.16	0.1134
	2	10.46	0.412	86.00	0.1333
	1	12.50	0.492	122.6	0.1901
	1/0	13.51	0.532	143.4	0.2223
	2/0	14.68	0.578	169.3	0.2624
	3/0	16.00	0.630	201.1	0.3117
	4/0	17.48	0.688	239.9	0.3718
	250	19.43	0.765	296.5	0.4596
	300	20.83	0.820	340.7	0.5281
	350	22.12	0.871	384.4	0.5958
	400	23.32	0.918	427.0	0.6619
	500	25.48	1.003	509.7	0.7901
	600	28.27	1.113	627.7	0.9729
	700	30.07	1.184	710.3	1.1010
	750	30.94	1.218	751.7	1.1652
	800	31.75	1.250	791.7	1.2272
	900	33.38	1.314	874.9	1.3561
	1000	34.85	1.372	953.8	1.4784
	1250	39.09	1.539	1200	1.8602
	1500	42.21	1.662	1400	2.1695
	1750	45.11	1.776	1598	2.4773
	2000	47.80	1.882	1795	2.7818
TFN, TFFN	18	2.134	0.084	3.548	0.0055
	16	2.438	0.096	4.645	0.0072
THHN, THWN, THWN-2	14	2.819	0.111	6.258	0.0097
	12	3.302	0.130	8.581	0.0133
	10	4.166	0.164	13.61	0.0211
	8	5.486	0.216	23.61	0.0366
	6	6.452	0.254	32.71	0.0507
	4	8.230	0.324	53.16	0.0824
	3	8.941	0.352	62.77	0.0973
	2	9.754	0.384	74.71	0.1158
	1	11.33	0.446	100.8	0.1562
	1/0	12.34	0.486	119.7	0.1855
	2/0	13.51	0.532	143.4	0.2223
	3/0	14.83	0.584	172.8	0.2679
	4/0	16.31	0.642	208.8	0.3237
	250	18.06	0.711	256.1	0.3970
	300	19.46	0.766	297.3	0.4608

(continued)

TABLE 2.17 NEC Chapter 9, Table 5: Dimensions of Insulated Conductors and Fixture Wires (Continued)

Type	Size (AWG or kcmil)	Approximate Diameter		Approximate Area	
		mm	in.	mm ²	in. ²
Type: FEP, FEPB, PAF, PAFF, PE, PFA, PFAH, PFE, PGF, PGFF, PTF, PTFF, TFE, THHN, THWN, THWN-2, Z, ZF, ZFF					
THHN, THWN, THWN-2	350	20.75	0.817	338.2	0.5242
	400	21.95	0.864	378.3	0.5863
	500	24.10	0.949	456.3	0.7073
	600	26.70	1.051	559.7	0.8676
	700	28.50	1.12 2	637.9	0.9887
	750	29.36	1.156	677.2	1.0496
	800	30.18	1.188	715.2	1.1085
	900	31.80	1.252	794.3	1.2311
	1000	33.27	1.310	869.5	1.3478
PE, PGFF, PGF, PFE, PTF, PAF, PTFF, PAFF	18	2.184	0.086	3.742	0.0058
	16	2.489	0.098	4.839	0.0075
PE, PGFF, PGF, PFE, PTF, PAF, PTFF, PAFF, TFE, PFA, FEPB, PFAH	14	2.870	0.113	6.452	0.0100
TFE, FEP, PFA, FEPB, PFAH	12	3.353	0.132	8.839	0.0137
	10	3.962	0.156	12.32	0.0191
	8	5.232	0.206	21.48	0.0333
	6	6.198	0.244	30.19	0.0468
	4	7.417	0.292	43.23	0.0670
	3	8.128	0.320	51.87	0.0804
	2	8.941	0.352	62.77	0.0973
TFE, PFAH	1	10.72	0.422	90.26	0.1399
TFE, PFA, PFAH, Z	1/0	11.73	0.462	108.1	0.1676
	2/0	12.90	0.508	130.8	0.2027
	3/0	14.22	0.560	158.9	0.2463
	4/0	15.70	0.618	193.5	0.3000
ZF, ZFF	18	1.930	0.076	2.903	0.0045
	16	2.235	0.088	3.935	0.0061
Z, ZF, ZFF	14	2.616	0.103	5.355	0.0083
Z	12	3.099	0.122	7.548	0.0117
	10	3.962	0.156	12.32	0.0191
	8	4.978	0.196	19.48	0.0302
	6	5.944	0.234	27.74	0.0430
	4	7.163	0.282	40.32	0.0625
	3	8.382	0.330	55.16	0.0855
	2	9.195	0.362	66.39	0.1029
	1	10.21	0.402	81.87	0.1269

Type	Size (AWG or kcmil)	Approximate Diameter		Approximate Area	
		mm	in.	mm ²	in. ²
Type: KF-1, KF-2, KFF-1, KFF-2, XHH, XHHW, XHHW-2, ZW					
XHHW, ZW, XHHW-2, XHH	14	3.378	0.133	8.968	0.0139
	12	3.861	0.152	11.68	0.0181
	10	4.470	0.176	15.68	0.0243
	8	5.994	0.236	28.19	0.0437
	6	6.960	0.274	38.06	0.0590
	4	8.179	0.322	52.52	0.0814
	3	8.890	0.350	62.06	0.0962
	2	9.703	0.382	73.94	0.1146
XHHW, XHHW-2, XHH	1	11.23	0.442	98.97	0.1534
	1/0	12.24	0.482	117.7	0.1825
	2/0	13.41	0.528	141.3	0.2190
	3/0	14.73	0.58	170.5	0.2642
	4/0	16.21	0.638	206.3	0.3197
	250	17.91	0.705	251.9	0.3904
	300	19.30	0.76	292.6	0.4536
	350	20.60	0.811	333.3	0.5166
	400	21.79	0.858	373.0	0.5782
	500	23.95	0.943	450.6	0.6984
	600	26.75	1.053	561.9	0.8709
	700	28.55	1.124	640.2	0.9923
	750	29.41	1.158	679.5	1.0532
	800	30.23	1.190	717.5	1.1122
	900	31.85	1.254	796.8	1.2351
	1000	33.32	1.312	872.2	1.3519
	1250	37.57	1.479	1108	1.7180
	1500	40.69	1.602	1300	2.0157
	1750	43.59	1.716	1492	2.3127
	2000	46.28	1.822	1682	2.6073
KF-2, KFF-2	18	1.600	0.063	2.000	0.0031
	16	1.905	0.075	2.839	0.0044
	14	2.286	0.090	4.129	0.0064
	12	2.769	0.109	6.000	0.0093
	10	3.378	0.133	8.968	0.0139
KF-1, KFF-1	18	1.448	0.057	1.677	0.0026
	16	1.753	0.069	2.387	0.0037
	14	2.134	0.084	3.548	0.0055
	12	2.616	0.103	5.355	0.0083
	10	3.226	0.127	8.194	0.0127

*Types RHH, RHW, and RHW-2 without outer covering.

(© 2001, NFPA)

TABLE 2.18 NEC Chapter 9, Table 8: Conductor Properties

Size (AWG or kcmil)	Conductors								Direct-Current Resistance at 75°C (167°F)							
	Area		Stranding		Overall				Copper				Aluminum			
	mm ²	Circular mils	Quantity	Diameter		Diameter		Area		Uncoated		Coated		ohm/ km	ohm/ kFT	
				mm	in.	mm	in.	mm ²	in. ²	ohm/ km	ohm/ kFT	ohm/ km	ohm/ kFT			
18	0.823	1620	1	—	—	1.02	0.040	0.823	0.001	25.5	7.77	26.5	8.08	42.0	12.8	
18	0.823	1620	7	0.39	0.015	1.16	0.046	1.06	0.002	26.1	7.95	27.7	8.45	42.8	13.1	
16	1.31	2580	1	—	—	1.29	0.051	1.31	0.002	16.0	4.89	16.7	5.08	26.4	8.05	
16	1.31	2580	7	0.49	0.019	1.46	0.058	1.68	0.003	16.4	4.99	17.3	5.29	26.9	8.21	
14	2.08	4110	1	—	—	1.63	0.064	2.08	0.003	10.1	3.07	10.4	3.19	16.6	5.06	
14	2.08	4110	7	0.62	0.024	1.85	0.073	2.68	0.004	10.3	3.14	10.7	3.26	16.9	5.17	
12	3.31	6530	1	—	—	2.05	0.081	3.31	0.005	6.34	1.93	6.57	2.01	10.45	3.18	
12	3.31	6530	7	0.78	0.030	2.32	0.092	4.25	0.006	6.50	1.98	6.73	2.05	10.69	3.25	
10	5.261	10380	1	—	—	2.588	0.102	5.26	0.008	3.984	1.21	4.148	1.26	6.561	2.00	
10	5.261	10380	7	0.98	0.038	2.95	0.116	6.76	0.011	4.070	1.24	4.226	1.29	6.679	2.04	
8	8.367	16510	1	—	—	3.264	0.128	8.37	0.013	2.506	0.764	2.579	0.786	4.125	1.26	
8	8.367	16510	7	1.23	0.049	3.71	0.146	10.76	0.017	2.551	0.778	2.653	0.809	4.204	1.28	
6	13.30	26240	7	1.56	0.061	4.67	0.184	17.09	0.027	1.608	0.491	1.671	0.510	2.652	0.808	
4	21.15	41740	7	1.96	0.077	5.89	0.232	27.19	0.042	1.010	0.308	1.053	0.321	1.666	0.508	
3	26.67	52620	7	2.20	0.087	6.60	0.260	34.28	0.053	0.802	0.245	0.833	0.254	1.320	0.403	
2	33.62	66360	7	2.47	0.097	7.42	0.292	43.23	0.067	0.634	0.194	0.661	0.201	1.045	0.319	
1	42.41	83690	19	1.69	0.066	8.43	0.332	55.80	0.087	0.505	0.154	0.524	0.160	0.829	0.253	
1/0	53.49	105600	19	1.89	0.074	9.45	0.372	70.41	0.109	0.399	0.122	0.415	0.127	0.660	0.201	
2/0	67.43	133100	19	2.13	0.084	10.62	0.418	88.74	0.137	0.3170	0.0967	0.329	0.101	0.523	0.159	
3/0	85.01	167800	19	2.39	0.094	11.94	0.470	111.9	0.173	0.2512	0.0766	0.2610	0.0797	0.413	0.126	
4/0	107.2	211600	19	2.68	0.106	13.41	0.528	141.1	0.219	0.1996	0.0608	0.2050	0.0626	0.328	0.100	
250	—	—	37	2.09	0.082	14.61	0.575	168	0.260	0.1687	0.0515	0.1753	0.0535	0.2778	0.0847	
300	—	—	37	2.29	0.090	16.00	0.630	201	0.312	0.1409	0.0429	0.1463	0.0446	0.2318	0.0707	
350	—	—	37	2.47	0.097	17.30	0.681	235	0.364	0.1205	0.0367	0.1252	0.0382	0.1984	0.0605	
400	—	—	37	2.64	0.104	18.49	0.728	268	0.416	0.1053	0.0321	0.1084	0.0331	0.1737	0.0529	
500	—	—	37	2.95	0.116	20.65	0.813	336	0.519	0.0845	0.0258	0.0869	0.0265	0.1391	0.0424	
600	—	—	61	2.52	0.099	22.68	0.893	404	0.626	0.0704	0.0214	0.0732	0.0223	0.1159	0.0353	
700	—	—	61	2.72	0.107	24.49	0.964	471	0.730	0.0603	0.0184	0.0622	0.0189	0.0994	0.0303	
750	—	—	61	2.82	0.111	25.35	0.998	505	0.782	0.0563	0.0171	0.0579	0.0176	0.0927	0.0282	
800	—	—	61	2.91	0.114	26.16	1.030	538	0.834	0.0528	0.0161	0.0544	0.0166	0.0868	0.0265	
900	—	—	61	3.09	0.122	27.79	1.094	606	0.940	0.0470	0.0143	0.0481	0.0147	0.0770	0.0235	
1000	—	—	61	3.25	0.128	29.26	1.152	673	1.042	0.0423	0.0129	0.0434	0.0132	0.0695	0.0212	
1250	—	—	91	2.98	0.117	32.74	1.289	842	1.305	0.0338	0.0103	0.0347	0.0106	0.0554	0.0169	
1500	—	—	91	3.26	0.128	35.86	1.412	1011	1.566	0.02814	0.00858	0.02814	0.00883	0.0464	0.0141	
1750	—	—	127	2.98	0.117	38.76	1.526	1180	1.829	0.02410	0.00735	0.02410	0.00756	0.0397	0.0121	
2000	—	—	127	3.19	0.126	41.45	1.632	1349	2.092	0.02109	0.00643	0.02109	0.00662	0.0348	0.0106	

Notes:

1. These resistance values are valid only for the parameters as given. Using conductors having coated strands, different stranding type, and, especially, other temperatures changes the resistance.
2. Formula for temperature change: $R_2 = R_1 [1 + \alpha (T_2 - 75)]$ where $\alpha_{Cu} = 0.00323$, $\alpha_{Al} = 0.00330$ at 75°C.
3. Conductors with compact and compressed stranding have about 9 percent and 3 percent, respectively, smaller bare conductor diameters than those shown. See Table 5A for actual compact cable dimensions.
4. The IACS conductivities used: bare copper = 100%, aluminum = 61%.
5. Class B stranding is listed as well as solid for some sizes. Its overall diameter and area is that of its circumscribing circle.

FPN: The construction information is per NEMA WCS-1992 or ANSI/UL 1581-1998. The resistance is calculated per National Bureau of Standards Handbook 100, dated 1966, and Handbook 109, dated 1972.

(© 2001, NFPA)

TABLE 2.19 NEC Chapter 9, Table 9: Alternating-Current Resistance and Reactance for 600-Volt Cables, 3-Phase, 60 Hz, 75°C (167°F)—Three Single Conductors in Conduit

Size (AWG or kcmil)	Ohms to Neutral per Kilometer Ohms to Neutral per 1000 Feet															Size (AWG or kcmil)
	X _L (Reactance) for All Wires		Alternating-Current Resistance for Uncoated Copper Wires			Alternating-Current Resistance for Aluminum Wires			Effective Z at 0.85 PF for Uncoated Copper Wires			Effective Z at 0.85 PF for Aluminum Wires				
	PVC, Aluminum Conduits	Steel Conduit	PVC Conduit	Aluminum Conduit	Steel Conduit	PVC Conduit	Aluminum Conduit	Steel Conduit	PVC Conduit	Aluminum Conduit	Steel Conduit	PVC Conduit	Aluminum Conduit	Steel Conduit		
14	0.190 0.058	0.240 0.073	10.2 3.1	10.2 3.1	10.2 3.1	— —	— —	— —	8.9 2.7	8.9 2.7	8.9 2.7	— —	— —	— —	14	
12	0.177 0.054	0.223 0.068	6.6 2.0	6.6 2.0	6.6 2.0	10.5 3.2	10.5 3.2	10.5 3.2	5.6 1.7	5.6 1.7	5.6 1.7	9.2 2.8	9.2 2.8	9.2 2.8	12	
10	0.164 0.050	0.207 0.063	3.9 1.2	3.9 1.2	3.9 1.2	6.6 2.0	6.6 2.0	6.6 2.0	3.6 1.1	3.6 1.1	3.6 1.1	5.9 1.8	5.9 1.8	5.9 1.8	10	
8	0.171 0.052	0.213 0.065	2.56 0.78	2.56 0.78	2.56 0.78	4.3 1.3	4.3 1.3	4.3 1.3	2.26 0.69	2.26 0.69	2.30 0.70	3.6 1.1	3.6 1.1	3.6 1.1	8	
6	0.167 0.051	0.210 0.064	1.61 0.49	1.61 0.49	1.61 0.49	2.66 0.81	2.66 0.81	2.66 0.81	1.44 0.44	1.48 0.45	1.48 0.45	2.33 0.71	2.36 0.72	2.36 0.72	6	
4	0.157 0.048	0.197 0.060	1.02 0.31	1.02 0.31	1.02 0.31	1.67 0.51	1.67 0.51	1.67 0.51	0.95 0.29	0.95 0.29	0.98 0.30	1.51 0.46	1.51 0.46	1.51 0.46	4	
3	0.154 0.047	0.194 0.059	0.82 0.25	0.82 0.25	0.82 0.25	1.31 0.40	1.35 0.41	1.31 0.40	0.75 0.23	0.79 0.24	0.79 0.24	1.21 0.37	1.21 0.37	1.21 0.37	3	
2	0.148 0.045	0.187 0.057	0.62 0.19	0.66 0.20	0.66 0.20	1.05 0.32	1.05 0.32	1.05 0.32	0.62 0.19	0.62 0.19	0.66 0.20	0.98 0.30	0.98 0.30	0.98 0.30	2	
1	0.151 0.046	0.187 0.057	0.49 0.15	0.52 0.16	0.52 0.16	0.82 0.25	0.85 0.26	0.82 0.25	0.52 0.16	0.52 0.16	0.52 0.16	0.79 0.24	0.79 0.24	0.82 0.25	1	
1/0	0.144 0.044	0.180 0.055	0.39 0.12	0.43 0.13	0.39 0.12	0.66 0.20	0.69 0.21	0.66 0.20	0.43 0.13	0.43 0.13	0.43 0.13	0.62 0.19	0.66 0.20	0.66 0.20	1/0	
2/0	0.141 0.043	0.177 0.054	0.33 0.10	0.33 0.10	0.33 0.10	0.52 0.16	0.52 0.16	0.52 0.16	0.36 0.11	0.36 0.11	0.36 0.11	0.52 0.16	0.52 0.16	0.52 0.16	2/0	
3/0	0.138 0.042	0.171 0.052	0.253 0.077	0.269 0.082	0.259 0.079	0.43 0.13	0.43 0.13	0.43 0.13	0.289 0.088	0.302 0.092	0.308 0.094	0.43 0.13	0.43 0.13	0.46 0.14	3/0	
4/0	0.135 0.041	0.167 0.051	0.203 0.062	0.220 0.067	0.207 0.063	0.33 0.10	0.36 0.11	0.33 0.10	0.243 0.074	0.256 0.078	0.262 0.080	0.36 0.11	0.36 0.11	0.36 0.11	4/0	
250	0.135 0.041	0.171 0.052	0.171 0.052	0.187 0.057	0.177 0.054	0.279 0.085	0.295 0.090	0.282 0.086	0.217 0.066	0.230 0.070	0.240 0.073	0.308 0.094	0.322 0.098	0.33 0.10	250	
300	0.135 0.041	0.167 0.051	0.144 0.044	0.161 0.049	0.148 0.045	0.233 0.071	0.249 0.076	0.236 0.072	0.194 0.059	0.207 0.063	0.213 0.065	0.269 0.082	0.282 0.086	0.289 0.088	300	
350	0.131 0.040	0.164 0.050	0.125 0.038	0.141 0.043	0.128 0.039	0.200 0.061	0.217 0.066	0.207 0.063	0.174 0.053	0.190 0.058	0.197 0.060	0.240 0.073	0.253 0.077	0.262 0.080	350	
400	0.131 0.040	0.161 0.049	0.108 0.033	0.125 0.038	0.115 0.035	0.177 0.054	0.194 0.059	0.180 0.055	0.161 0.049	0.174 0.053	0.184 0.056	0.216 0.066	0.233 0.071	0.240 0.073	400	
500	0.128 0.039	0.157 0.048	0.089 0.027	0.105 0.032	0.095 0.029	0.141 0.043	0.157 0.048	0.148 0.045	0.141 0.043	0.157 0.048	0.164 0.050	0.187 0.057	0.200 0.061	0.210 0.064	500	
600	0.128 0.039	0.157 0.048	0.075 0.023	0.092 0.028	0.082 0.025	0.118 0.036	0.135 0.041	0.125 0.038	0.131 0.040	0.144 0.044	0.154 0.047	0.167 0.051	0.180 0.055	0.190 0.058	600	

(continued)

TABLE 2.19 NEC Chapter 9, Table 9: Alternating-Current Resistance and Reactance for 600-Volt Cables, 3-Phase, 60 Hz, 75°C (167°F)—Three Single Conductors in Conduit (Continued)

		Ohms to Neutral per Kilometer Ohms to Neutral per 1000 Feet																	
		X _L (Reactance) for All Wires			Alternating-Current Resistance for Uncoated Copper Wires			Alternating-Current Resistance for Aluminum Wires			Effective Z at 0.85 PF for Uncoated Copper Wires			Effective Z at 0.85 PF for Aluminum Wires					
Size (AWG or kcmil)		PVC, Aluminum Conduits	Steel Conduit	PVC Conduit	Aluminum Conduit	Steel Conduit	PVC Conduit	Aluminum Conduit	Steel Conduit	PVC Conduit	Aluminum Conduit	Steel Conduit	PVC Conduit	Aluminum Conduit	Steel Conduit	PVC Conduit	Aluminum Conduit	Steel Conduit	Size (AWG or kcmil)
		750		0.125 0.038	0.157 0.048	0.062 0.019	0.079 0.024	0.069 0.021	0.095 0.029	0.112 0.034	0.102 0.031	0.118 0.036	0.131 0.040	0.141 0.043	0.148 0.045	0.161 0.049	0.171 0.052	0.148 0.045	
1000		0.121 0.037	0.151 0.046	0.049 0.015	0.062 0.019	0.059 0.018	0.075 0.023	0.089 0.027	0.082 0.025	0.105 0.032	0.118 0.036	0.131 0.040	0.128 0.039	0.138 0.042	0.151 0.046	0.128 0.039	0.138 0.042	0.151 0.046	1000

Notes:

- These values are based on the following constants: UL-Type RHH wires with Class B stranding, in cradled configuration. Wire conductivities are 100 percent IACS copper and 61 percent IACS aluminum, and aluminum conduit is 45 percent IACS. Capacitive reactance is ignored, since it is negligible at these voltages. These resistance values are valid only at 75°C (167°F) and for the parameters as given, but are representative for 600-volt wire types operating at 60 Hz.
- Effective Z is defined as $R \cos(\theta) + X \sin(\theta)$, where θ is the power factor angle of the circuit. Multiplying current by effective impedance gives a good approximation for line-to-neutral voltage drop. Effective impedance values shown in this table are valid only at 0.85 power factor. For another circuit power factor (PF), effective impedance (Ze) can be calculated from R and X_L values given in this table as follows: $Z_e = R \times PF + X_L \sin(\arccos(PF))$.

(© 2001, NFPA)

2.6 NEC APPENDIX C (PARTIAL)

Introduction

This appendix is not a part of the requirements of the NEC and is included for information only. However, by using the tables in this appendix, one is afforded very accurate calculations without having to perform the calculations according to NEC Chap. 9, Table 1.

Tables 2.20 through 2.31 (NEC Tables C1 through C12), inclusive, are included. NEC Tables C1A through C12A are not included here because they cover fill for compact conductors, which are rarely used in the building industry. If you need these fill requirements, please refer to Appendix C of the NEC.

TABLE 2.20 NEC Table C1: Maximum Number of Conductors or Fixture Wires in Electrical Metallic Tubing

CONDUCTORS												
Type	Conductor Size (AWG/kcmil)	Metric Designator (Trade Size)										
		16 (½)	21 (¾)	27 (1)	35 (1¼)	41 (1½)	53 (2)	63 (2½)	78 (3)	91 (3½)	103 (4)	
RHH, RHW, RHW-2	14	4	7	11	20	27	46	80	120	157	201	
	12	3	6	9	17	23	38	66	100	131	167	
	10	2	5	8	13	18	30	53	81	105	135	
	8	1	2	4	7	9	16	28	42	55	70	
	6	1	1	3	5	8	13	22	34	44	56	
	4	1	1	2	4	6	10	17	26	34	44	
	3	1	1	1	4	5	9	15	23	30	38	
	2	1	1	1	3	4	7	13	20	26	33	
	1	0	1	1	1	3	5	9	13	17	22	
	1/0	0	1	1	1	2	4	7	11	15	19	
	2/0	0	1	1	1	2	4	6	10	13	17	
	3/0	0	0	1	1	1	3	5	8	11	14	
	4/0	0	0	1	1	1	3	5	7	9	12	
	250	0	0	0	1	1	1	3	5	7	9	
	300	0	0	0	1	1	1	3	5	6	8	
	350	0	0	0	1	1	1	3	4	6	7	
	400	0	0	0	1	1	1	2	4	5	7	
	500	0	0	0	0	1	1	2	3	4	6	
	600	0	0	0	0	1	1	1	3	4	5	
	700	0	0	0	0	0	1	1	2	3	4	
	750	0	0	0	0	0	1	1	2	3	4	
	800	0	0	0	0	0	1	1	2	3	4	
	900	0	0	0	0	0	1	1	1	3	3	
	1000	0	0	0	0	0	1	1	1	2	3	
	1250	0	0	0	0	0	0	1	1	1	2	
	1500	0	0	0	0	0	0	1	1	1	1	
	1750	0	0	0	0	0	0	1	1	1	1	
	2000	0	0	0	0	0	0	1	1	1	1	
	TW,	14	8	15	25	43	58	96	168	254	332	424
	THHW,	12	6	11	19	33	45	74	129	195	255	326
THW,	10	5	8	14	24	33	55	96	145	190	243	
THW-2	8	2	5	8	13	18	30	53	81	105	135	

(continued)

TABLE 2.20 NEC Table C1: Maximum Number of Conductors or Fixture Wires in Electrical Metallic Tubing
(Continued)

CONDUCTORS											
Type	Conductor Size (AWG/kcmil)	Metric Designator (Trade Size)									
		16 (½)	21 (¾)	27 (1)	35 (1¼)	41 (1½)	53 (2)	63 (2½)	78 (3)	91 (3½)	103 (4)
RHH*, RHW*, RHW-2*	14	6	10	16	28	39	64	112	169	221	282
	12	4	8	13	23	31	51	90	136	177	227
	10	3	6	10	18	24	40	70	106	138	177
	8	1	4	6	10	14	24	42	63	83	106
RHH*, RHW*, RHW-2*, TW, THW, THHW, THW-2	6	1	3	4	8	11	18	32	48	63	81
	4	1	1	3	6	8	13	24	36	47	60
	3	1	1	3	5	7	12	20	31	40	52
	2	1	1	2	4	6	10	17	26	34	44
	1	1	1	1	3	4	7	12	18	24	31
	1/0	0	1	1	2	3	6	10	16	20	26
	2/0	0	1	1	1	3	5	9	13	17	22
	3/0	0	1	1	1	2	4	7	11	15	19
	4/0	0	0	1	1	1	3	6	9	12	16
	250	0	0	1	1	1	3	5	7	10	13
300	0	0	1	1	1	2	4	6	8	11	
350	0	0	0	1	1	1	4	6	7	10	
400	0	0	0	1	1	1	3	5	7	9	
500	0	0	0	1	1	1	3	4	6	7	
600	0	0	0	1	1	1	2	3	4	6	
700	0	0	0	0	1	1	1	3	4	5	
750	0	0	0	0	1	1	1	3	4	5	
800	0	0	0	0	1	1	1	3	3	5	
900	0	0	0	0	0	1	1	2	3	4	
1000	0	0	0	0	0	1	1	2	3	4	
1250	0	0	0	0	0	1	1	1	2	3	
1500	0	0	0	0	0	1	1	1	1	2	
1750	0	0	0	0	0	0	1	1	1	2	
2000	0	0	0	0	0	0	1	1	1	1	
THHN, THWN, THWN-2	14	12	22	35	61	84	138	241	364	476	608
	12	9	16	26	45	61	101	176	266	347	443
	10	5	10	16	28	38	63	111	167	219	279
	8	3	6	9	16	22	36	64	96	126	161
	6	2	4	7	12	16	26	46	69	91	116
	4	1	2	4	7	10	16	28	43	56	71
	3	1	1	3	6	8	13	24	36	47	60
	2	1	1	3	5	7	11	20	30	40	51
	1	1	1	1	4	5	8	15	22	29	37
	1/0	1	1	1	3	4	7	12	19	25	32
2/0	0	1	1	2	3	6	10	16	20	26	
3/0	0	1	1	1	3	5	8	13	17	22	
4/0	0	1	1	1	2	4	7	11	14	18	
250	0	0	1	1	1	3	6	9	11	15	
300	0	0	1	1	1	3	5	7	10	13	
350	0	0	1	1	1	2	4	6	9	11	
400	0	0	0	1	1	1	4	6	8	10	
500	0	0	0	1	1	1	3	5	6	8	
600	0	0	0	1	1	1	2	4	5	7	
700	0	0	0	1	1	1	2	3	4	6	
750	0	0	0	0	1	1	1	3	4	5	
800	0	0	0	0	1	1	1	3	4	5	
900	0	0	0	0	1	1	1	3	3	4	
1000	0	0	0	0	1	1	1	2	3	4	
FEP, FEPB, PFA, PFAH, TFE	14	12	21	34	60	81	134	234	354	462	590
	12	9	15	25	43	59	98	171	258	337	430
	10	6	11	18	31	42	70	122	185	241	309
	8	3	6	10	18	24	40	70	106	138	177
	6	2	4	7	12	17	28	50	75	98	126
	4	1	3	5	9	12	20	35	53	69	88
PFA, PFAH, TFE	3	1	2	4	7	10	16	29	44	57	73
	2	1	1	3	6	8	13	24	36	47	60
	1	1	1	2	4	6	9	16	25	33	42
	1/0	1	1	1	3	5	8	14	21	27	35
TFE PFA, PFAH, TFE, Z	2/0	0	1	1	3	4	6	11	17	22	29
	3/0	0	1	1	2	3	5	9	14	18	24
	4/0	0	1	1	1	2	4	8	11	15	19

(continued)

TABLE 2.20 NEC Table C1: Maximum Number of Conductors or Fixture Wires in Electrical Metallic Tubing (*Continued*)

CONDUCTORS											
Type	Conductor Size (AWG/kcmil)	Metric Designator (Trade Size)									
		16 (%)	21 (%)	27 (1)	35 (1½)	41 (1½)	53 (2)	63 (2½)	78 (3)	91 (3½)	103 (4)
Z	14	14	25	41	72	98	161	282	426	556	711
	12	10	18	29	51	69	114	200	302	394	504
	10	6	11	18	31	42	70	122	185	241	309
	8	4	7	11	20	27	44	77	117	153	195
	6	3	5	8	14	19	31	54	82	107	137
	4	1	3	5	9	13	21	37	56	74	94
	3	1	2	4	7	9	15	27	41	54	69
	2	1	1	3	6	8	13	22	34	45	57
	1	1	1	2	4	6	10	18	28	36	46
	XHH, XHHW, XHHW-2, ZW	14	8	15	25	43	58	96	168	254	332
12		6	11	19	33	45	74	129	195	255	326
10		5	8	14	24	33	55	96	145	190	243
8		2	5	8	13	18	30	53	81	105	135
6		1	3	6	10	14	22	39	60	78	100
4		1	2	4	7	10	16	28	43	56	72
XHH, XHHW, XHHW-2	1	1	1	1	4	5	8	15	23	30	38
	1/0	1	1	1	3	4	7	13	19	25	32
	2/0	0	1	1	2	3	6	10	16	21	27
	3/0	0	1	1	1	3	5	9	13	17	22
	4/0	0	1	1	1	2	4	7	11	14	18
	250	0	0	1	1	1	3	6	9	12	15
300	0	0	1	1	1	3	5	8	10	13	
350	0	0	1	1	1	2	4	7	9	11	
400	0	0	0	1	1	1	4	6	8	10	
500	0	0	0	1	1	1	3	5	6	8	
600	0	0	0	1	1	1	2	4	5	6	
700	0	0	0	0	1	1	2	3	4	6	
750	0	0	0	0	1	1	1	3	4	5	
800	0	0	0	0	1	1	1	3	4	5	
900	0	0	0	0	1	1	1	3	3	4	
1000	0	0	0	0	0	1	1	2	3	4	
1250	0	0	0	0	0	1	1	1	2	3	
1500	0	0	0	0	0	1	1	1	1	3	
1750	0	0	0	0	0	0	1	1	1	2	
2000	0	0	0	0	0	0	1	1	1	1	

FIXTURE WIRES							
Type	Conductor Size (AWG/kcmil)	Metric Designator (Trade Size)					
		16 (%)	21 (%)	27 (1)	35 (1½)	41 (1½)	53 (2)
FFH-2, RFH-2, RFHH-3	18	8	14	24	41	56	92
SF-2, SFF-2	18	10	18	30	52	71	116
SF-1, SFF-1	18	8	15	25	43	58	96
RFH-1, RFHH-2, TF, TFF, XF, XFF	18	7	12	20	34	47	78
RFH-2, TF, TFF, XF, XFF	16	11	19	31	55	74	123
XF, XFF	14	8	15	25	43	58	96
TFN, TFFN	18	22	38	63	108	148	244
PF, PFF, PGF, PGFF, PAF, PTF, PTFF, PAFF	16	17	29	48	83	113	186
ZF, ZFF, ZHF, HF, HFF	18	21	36	59	103	140	231
XF-2, KFF-2	16	16	28	46	79	108	179
KF-1, KFF-1	14	12	21	34	60	81	134
XF, XFF	18	27	47	77	133	181	298
	16	20	35	56	98	133	220
	14	14	25	41	72	98	161
	18	39	69	111	193	262	433
	16	27	48	78	136	185	305
	14	19	33	54	93	127	209
	12	13	23	37	64	87	144
	10	8	15	25	43	58	96
	18	46	82	133	220	313	516
	16	33	57	93	161	220	362
	14	22	38	63	108	148	244
	12	14	25	41	72	98	161
	10	9	16	27	47	64	105
	12	4	8	13	23	31	51
	10	3	6	10	18	24	40

Note: This table is for concentric stranded conductors only. For compact stranded conductors, Table C1(A) should be used.
 *Types RHH, RHW, and RHW-2 without outer covering.

TABLE 2.21 NEC Table C2: Maximum Number of Conductors or Fixture Wires in Electrical Nonmetallic Tubing

CONDUCTORS							
Type	Conductor Size (AWG/kcmil)	Metric Designator (Trade Size)					
		16 (½)	21 (¾)	27 (1)	35 (1¼)	41 (1½)	53 (2)
RHH, RHW,	14	3	6	10	19	26	43
RHW-2	12	2	5	9	16	22	36
RHH,	10	1	4	7	13	17	29
RHW,	8	1	1	3	6	9	15
RHW-2	6	1	1	3	5	7	12
	4	1	1	2	4	6	9
	3	1	1	1	3	5	8
	2	0	1	1	3	4	7
	1	0	1	1	1	3	5
	1/0	0	0	1	1	2	4
	2/0	0	0	1	1	1	3
	3/0	0	0	1	1	1	3
	4/0	0	0	1	1	1	2
	250	0	0	0	1	1	1
	300	0	0	0	1	1	1
	350	0	0	0	1	1	1
	400	0	0	0	1	1	1
	500	0	0	0	0	1	1
	600	0	0	0	0	1	1
	700	0	0	0	0	0	1
	750	0	0	0	0	0	1
	800	0	0	0	0	0	1
	900	0	0	0	0	0	1
	1000	0	0	0	0	0	1
	1250	0	0	0	0	0	0
	1500	0	0	0	0	0	0
	1750	0	0	0	0	0	0
	2000	0	0	0	0	0	0
TW, THHW,	14	7	13	22	40	55	92
THW,							
THW-2	12	5	10	17	31	42	71
	10	4	7	13	23	32	52
	8	1	4	7	13	17	29
RHH*,	14	4	8	15	27	37	61
RHW*,							
RHW-2*							
	12	3	7	12	21	29	49
	10	3	5	9	17	23	38
	8	1	3	5	10	14	23
RHH*,							
RHW*,							
RHW-2*,							
TW, THW,	6	1	2	4	7	10	17
THHW,	4	1	1	3	5	8	13
THW-2	3	1	1	2	5	7	11
	2	1	1	2	4	6	9
	1	0	1	1	3	4	6
	1/0	0	1	1	2	3	5
	2/0	0	1	1	1	3	5
	3/0	0	0	1	1	2	4
	4/0	0	0	1	1	1	3
	250	0	0	1	1	1	2
	300	0	0	0	1	1	2
	350	0	0	0	1	1	1
	400	0	0	0	1	1	1
	500	0	0	0	1	1	1
	600	0	0	0	0	1	1
	700	0	0	0	0	1	1
	750	0	0	0	0	1	1
	800	0	0	0	0	1	1
	900	0	0	0	0	0	1
	1000	0	0	0	0	0	1
	1250	0	0	0	0	0	1
	1500	0	0	0	0	0	0
	1750	0	0	0	0	0	0
	2000	0	0	0	0	0	0

(continued)

TABLE 2.21 NEC Table C2: Maximum Number of Conductors or Fixture Wires in Electrical Nonmetallic Tubing (*Continued*)

CONDUCTORS							
Type	Conductor Size (AWG/kcmil)	Metric Designator (Trade Size)					
		16 (½)	21 (¾)	27 (1)	35 (1¼)	41 (1½)	53 (2)
THHN, THWN, THWN-2	14	10	18	32	58	80	132
	12	7	13	23	42	58	96
	10	4	8	15	26	36	60
	8	2	5	8	15	21	35
	6	1	3	6	11	15	25
	4	1	1	4	7	9	15
	3	1	1	3	5	8	13
	2	1	1	2	5	6	11
	1	1	1	1	3	5	8
	1/0	0	1	1	3	4	7
	2/0	0	1	1	2	3	5
	3/0	0	1	1	1	3	4
	4/0	0	0	1	1	2	4
	250	0	0	1	1	1	3
	300	0	0	1	1	1	2
	350	0	0	0	1	1	2
	400	0	0	0	1	1	1
	500	0	0	0	1	1	1
	600	0	0	0	1	1	1
	700	0	0	0	0	1	1
750	0	0	0	0	1	1	
800	0	0	0	0	1	1	
900	0	0	0	0	1	1	
1000	0	0	0	0	0	1	
FEP, FEPB, PFA, PFAH, TFE	14	10	18	31	56	77	128
	12	7	13	23	41	56	93
	10	5	9	16	29	40	67
	8	3	5	9	17	23	38
	6	1	4	6	12	16	27
	4	1	2	4	8	11	19
PFA, PFAH, TFE	3	1	1	4	7	9	16
	2	1	1	3	5	8	13
	1	1	1	1	4	5	9
	1/0	0	1	1	3	4	7
PFA, PFAH, TFE, Z	2/0	0	1	1	2	4	6
	3/0	0	1	1	1	3	5
	4/0	0	1	1	1	2	4
	14	12	22	38	68	93	154
Z	12	8	15	27	48	66	109
	10	5	9	16	29	40	67
	8	3	6	10	18	25	42
	6	1	4	7	13	18	30
	4	1	3	5	9	12	20
	3	1	1	3	6	9	15
	2	1	1	3	5	7	12
	1	1	1	2	4	6	10
	14	7	13	22	40	55	92
	XHH, XHHW, XHHW-2, ZW	12	5	10	17	31	42
10		4	7	13	23	32	52
8		1	4	7	13	17	29
6		1	3	5	9	13	21
4		1	1	4	7	9	15
3		1	1	3	6	8	13
2		1	1	2	5	6	11
1		1	1	1	3	5	8
1/0		0	1	1	3	4	7
XHH, XHHW, XHHW-2		2/0	0	1	1	2	3
	3/0	0	1	1	1	3	5
	4/0	0	0	1	1	2	4
	250	0	0	1	1	1	3
	300	0	0	1	1	1	3
	350	0	0	1	1	1	2
	400	0	0	0	1	1	1
	500	0	0	0	1	1	1
	600	0	0	0	1	1	1
	700	0	0	0	0	1	1
	750	0	0	0	0	1	1
	800	0	0	0	0	1	1
	900	0	0	0	0	1	1
	1000	0	0	0	0	0	1
	1250	0	0	0	0	0	1
	1500	0	0	0	0	0	1
	1750	0	0	0	0	0	0
	2000	0	0	0	0	0	0

(continued)

TABLE 2.21 NEC Table C2: Maximum Number of Conductors or Fixture Wires in Electrical Nonmetallic Tubing (*Continued*)

FIXTURE WIRES							
Type	Conductor Size (AWG/kcmil)	Metric Designator (Trade Size)					
		16 (½)	21 (¾)	27 (1)	35 (1¼)	41 (1½)	53 (2)
FFH-2, RFH-2, RFHH-3	18	6	12	21	39	53	88
SF-2, SFF-2	16	5	10	18	32	45	74
SF-1, SFF-1	18	8	15	27	49	67	111
	16	7	13	22	40	55	92
	14	5	10	18	32	45	74
RFH-1, RFHH-2, TF, TFF, XF, XFF	18	11	20	35	64	88	145
RFHH-2, TF, TFF, XF, XFF	16	9	16	29	51	71	117
XF, XFF	14	7	13	22	40	55	92
TFN, TFFN	18	18	33	57	102	141	233
	16	13	25	43	78	107	178
PF, PFF, PGF, PGFF, PAF, PTF, PTFF, PAFF	18	17	31	54	97	133	221
	16	13	24	42	75	103	171
	14	10	18	31	56	77	128
ZF, ZFF, ZHF, HF, HFF	18	22	40	70	125	172	285
	16	16	29	51	92	127	210
	14	12	22	38	68	93	154
KF-2, KFF-2	18	31	58	101	182	250	413
	16	22	41	71	128	176	291
	14	15	28	49	88	121	200
	12	10	19	33	60	83	138
	10	7	13	22	40	55	92
KF-1, KFF-1	18	38	69	121	217	298	493
	16	26	49	85	152	209	346
	14	18	33	57	102	141	233
	12	12	22	38	68	93	154
	10	7	14	24	44	61	101
XF, XFF	12	3	7	12	21	29	49
	10	3	5	9	17	23	38

Note: This table is for concentric stranded conductors only. For compact stranded conductors, Table C2(A) should be used.

*Types RHH, RHW, and RHW-2 without outer covering.

(© 2001, NFPA)

TABLE 2.22 NEC Table C3: Maximum Number of Conductors or Fixture Wires in Flexible Metal Conduit

CONDUCTORS											
Type	Conductor Size (AWG/kcmil)	Metric Designator (Trade Size)									
		16 (½)	21 (¾)	27 (1)	35 (1¼)	41 (1½)	53 (2)	63 (2½)	78 (3)	91 (3¾)	103 (4)
RHH, RHW, RHW-2	14	4	7	11	17	25	44	67	96	131	171
	12	3	6	9	14	21	37	55	80	109	142
RHH, RHW, RHW-2	10	3	5	7	11	17	30	45	64	88	115
	8	1	2	4	6	9	15	23	34	46	60
RHW-2	6	1	1	3	5	7	12	19	27	37	48
	4	1	1	2	4	5	10	14	21	29	37
	3	1	1	1	3	5	8	13	18	25	33
	2	1	1	1	3	4	7	11	16	22	28
	1	0	1	1	1	2	5	7	10	14	19
	1/0	0	1	1	1	2	4	6	9	12	16
	2/0	0	1	1	1	1	3	5	8	11	14
	3/0	0	0	1	1	1	3	5	7	9	12
	4/0	0	0	1	1	1	2	4	6	8	10
	250	0	0	0	1	1	1	3	4	6	8
	300	0	0	0	1	1	1	2	4	5	7
350	0	0	0	1	1	1	2	3	5	6	
400	0	0	0	0	1	1	1	3	4	6	
500	0	0	0	0	1	1	1	3	4	5	
600	0	0	0	0	1	1	1	2	3	4	
700	0	0	0	0	0	1	1	1	3	3	
750	0	0	0	0	0	1	1	1	2	3	
800	0	0	0	0	0	1	1	1	2	3	
900	0	0	0	0	0	1	1	1	2	3	
1000	0	0	0	0	0	1	1	1	1	3	
1250	0	0	0	0	0	0	1	1	1	1	
1500	0	0	0	0	0	0	1	1	1	1	
1750	0	0	0	0	0	0	1	1	1	1	
2000	0	0	0	0	0	0	0	1	1	1	
TW,	14	9	15	23	36	53	94	141	203	277	361
THHW,	12	7	11	18	28	41	72	108	156	212	277
THW,	10	5	8	13	21	30	54	81	116	158	207
THW-2	8	3	5	7	11	17	30	45	64	88	115
RHH*, RHW*, RHW-2*	14	6	10	15	24	35	62	94	135	184	240
RHH*, RHW*, RHW-2*	12	5	8	12	19	28	50	75	108	148	193
RHH*, RHW*, RHW-2*	10	4	6	10	15	22	39	59	85	115	151
RHH*, RHW*, RHW-2*	8	1	4	6	9	13	23	35	51	69	90

(continued)

TABLE 2.22 NEC Table C3: Maximum Number of Conductors or Fixture Wires in Flexible Metal Conduit (*Continued*)

		CONDUCTORS									
Type	Conductor Size (AWG/kcmil)	Metric Designator (Trade Size)									
		16 (½)	21 (¾)	27 (1)	35 (1¼)	41 (1½)	53 (2)	63 (2½)	78 (3)	91 (3½)	103 (4)
RHH*, RHW*, RHW-2*, TW, THW, THHW, THW-2	6	1	3	4	7	10	18	27	39	53	69
	4	1	1	3	5	7	13	20	29	39	51
	3	1	1	3	4	6	11	17	25	34	44
	2	1	1	2	4	5	10	14	21	29	37
	1	1	1	1	2	4	7	10	15	20	26
	1/0	0	1	1	1	3	6	9	12	17	22
	2/0	0	1	1	1	3	5	7	10	14	19
	3/0	0	1	1	1	2	4	6	9	12	16
	4/0	0	0	1	1	1	3	5	7	10	13
	250	0	0	1	1	1	3	4	6	8	11
	300	0	0	1	1	1	2	3	5	7	9
	350	0	0	0	1	1	1	3	4	6	8
	400	0	0	0	1	1	1	3	4	6	7
	500	0	0	0	1	1	1	2	3	5	6
	600	0	0	0	0	1	1	1	3	4	5
	700	0	0	0	0	1	1	1	2	3	4
	750	0	0	0	0	1	1	1	2	3	4
	800	0	0	0	0	1	1	1	1	3	4
	900	0	0	0	0	0	1	1	1	3	3
	1000	0	0	0	0	0	1	1	1	2	3
	1250	0	0	0	0	0	1	1	1	1	2
	1500	0	0	0	0	0	0	1	1	1	1
	1750	0	0	0	0	0	0	1	1	1	1
	2000	0	0	0	0	0	0	1	1	1	1
THHN, THWN, THWN-2	14	13	22	33	52	76	134	202	291	396	518
	12	9	16	24	38	56	98	147	212	289	378
	10	6	10	15	24	35	62	93	134	182	238
	8	3	6	9	14	20	35	53	77	105	137
	6	2	4	6	10	14	25	38	55	75	99
	4	1	2	4	6	9	16	24	34	46	61
	3	1	1	3	5	7	13	20	29	39	51
	2	1	1	3	4	6	11	17	24	33	43
	1	1	1	1	3	4	8	12	18	24	32
	1/0	1	1	1	2	4	7	10	15	20	27
	2/0	0	1	1	1	3	6	9	12	17	22
	3/0	0	1	1	1	2	5	7	10	14	18
	4/0	0	1	1	1	1	4	6	8	12	15
	250	0	0	1	1	1	3	5	7	9	12
	300	0	0	1	1	1	3	4	6	8	11
	350	0	0	1	1	1	2	3	5	7	9
	400	0	0	0	1	1	1	3	5	6	8
	500	0	0	0	1	1	1	2	4	5	7
	600	0	0	0	0	1	1	1	3	4	5
	700	0	0	0	0	1	1	1	3	4	5
	750	0	0	0	0	1	1	1	2	3	4
	800	0	0	0	0	1	1	1	2	3	4
	900	0	0	0	0	0	1	1	1	3	4
	1000	0	0	0	0	0	1	1	1	3	3
PEP, FEFB, PFA, PFAH, TFE	14	12	21	32	51	74	130	196	282	385	502
	12	9	15	24	37	54	95	143	206	281	367
	10	6	11	17	26	39	68	103	148	201	263
	8	4	6	10	15	22	39	59	85	115	151
	6	2	4	7	11	16	28	42	60	82	107
	4	1	3	5	7	11	19	29	42	57	75
	3	1	2	4	6	9	16	24	35	48	62
	2	1	1	3	5	7	13	20	29	39	51
PFA, PFAH, TFE	1	1	1	2	3	5	9	14	20	27	36
PFA, PFAH, TFE, Z	1/0	1	1	1	3	4	8	11	17	23	30
	2/0	1	1	1	2	3	6	9	14	19	24
	3/0	0	1	1	1	3	5	8	11	15	20
	4/0	0	1	1	1	2	4	6	9	13	16
Z	14	15	25	39	61	89	157	236	340	463	605
	12	11	18	28	43	63	111	168	241	329	429
	10	6	11	17	26	39	68	103	148	201	263
	8	4	7	11	17	24	43	65	93	127	166
	6	3	5	7	12	17	30	45	65	89	117
	4	1	3	5	8	12	21	31	45	61	80
	3	1	2	4	6	8	15	23	33	45	58
	2	1	1	3	5	7	12	19	27	37	49
	1	1	1	2	4	6	10	15	22	30	39
XHHH, XHHW, XHHW-2, ZW	14	9	15	23	36	53	94	141	203	277	361
	12	7	11	18	28	41	72	108	156	212	277
	10	5	8	13	21	30	54	81	116	158	207
	8	3	5	7	11	17	30	45	64	88	115
	6	1	3	5	8	12	22	33	48	65	85
	4	1	2	4	6	9	16	24	34	47	61
	3	1	1	3	5	7	13	20	29	40	52
	2	1	1	3	4	6	11	17	24	33	44

(continued)

TABLE 2.22 NEC Table C3: Maximum Number of Conductors or Fixture Wires in Flexible Metal Conduit (Continued)

CONDUCTORS											
Type	Conductor Size (AWG/kcmil)	Metric Designator (Trade Size)									
		16 (½)	21 (¾)	27 (1)	35 (1¼)	41 (1½)	53 (2)	63 (2½)	78 (3)	91 (3½)	103 (4)
XHH, XHHW, XHHW-2	1	1	1	1	3	5	8	13	18	25	32
	1/0	1	1	1	2	4	7	10	15	21	27
	2/0	0	1	1	2	3	6	9	13	17	23
	3/0	0	1	1	1	3	5	7	10	14	19
	4/0	0	1	1	1	2	4	6	9	12	15
	250	0	0	1	1	1	3	5	7	10	13
	300	0	0	1	1	1	3	4	6	8	11
	350	0	0	1	1	1	2	4	5	7	9
	400	0	0	0	1	1	1	3	5	6	8
	500	0	0	0	1	1	1	3	4	5	7
	600	0	0	0	0	1	1	1	3	4	5
	700	0	0	0	0	1	1	1	3	4	5
	750	0	0	0	0	1	1	1	2	3	4
	800	0	0	0	0	1	1	1	2	3	4
	900	0	0	0	0	0	1	1	1	3	4
	1000	0	0	0	0	0	1	1	1	3	3
	1250	0	0	0	0	0	1	1	1	1	3
	1500	0	0	0	0	0	1	1	1	1	2
	1750	0	0	0	0	0	0	1	1	1	1
	2000	0	0	0	0	0	0	1	1	1	1

*Types RHH, RHW, and RHW-2 without outer covering.

FIXTURE WIRES							
Type	Conductor Size (AWG/kcmil)	Metric Designator (Trade Size)					
		16 (½)	21 (¾)	27 (1)	35 (1¼)	41 (1½)	53 (2)
FFH-2, RFH-2, RFHH-3	18	8	14	22	35	51	90
SF-2, SFF-2	16	7	12	19	29	43	76
SF-1, SFF-1	18	11	18	28	44	64	113
	16	9	15	23	36	53	94
	14	7	12	19	29	43	76
RFH-1, RFHH-2, TF, TFF, XF, XFF	18	19	32	50	78	114	201
RFHH-2, TF, TFF, XF, XFF	18	14	24	37	58	84	148
RFHH-2, TF, TFF, XF, XFF	16	11	19	30	47	68	120
XF, XFF	14	9	15	23	36	53	94
TFN, TFFN	18	23	38	59	93	135	237
PF, PFF, PGF, PGFF, PAF, PTF, PTFF, PAFF	16	17	29	45	71	103	181
	18	22	36	56	88	128	225
	16	17	28	43	68	99	174
	14	12	21	32	51	74	130
ZF, ZFF, ZHF, HF, HFF	18	28	47	72	113	165	290
KF-2, KFF-2	16	20	35	53	83	121	214
	14	15	25	39	61	89	157
	18	41	68	105	164	239	421
	16	28	48	74	116	168	297
	14	19	33	51	80	116	204
KF-1, KFF-1	12	13	23	35	55	80	140
	10	9	15	23	36	53	94
	18	48	82	125	196	285	503
	16	34	57	88	138	200	353
	14	23	38	59	93	135	237
XF, XFF	12	15	25	39	61	89	157
	10	10	16	25	40	58	103
	12	5	8	12	19	28	50
	10	4	6	10	15	22	39

Note: This table is for concentric stranded conductors only. For compact stranded conductors, Table C3(A) should be used.

(© 2001, NFPA)

TABLE 2.23 NEC Table C4: Maximum Number of Conductors or Fixture Wires in Intermediate Metal Conduit

CONDUCTORS											
Type	Conductor Size (AWG/kcmil)	Metric Designator (Trade Size)									
		16 (½)	21 (¾)	27 (1)	35 (1¼)	41 (1½)	53 (2)	63 (2½)	78 (3)	91 (3½)	103 (4)
RHH, RHW-2	14	4	8	13	22	30	49	70	108	144	186
RHH, RHW-2	12	4	6	11	18	25	41	58	89	120	154
RHH, RHW-2	10	3	5	8	15	20	33	47	72	97	124
RHH, RHW-2	8	1	3	4	8	10	17	24	38	50	65
RHH, RHW-2	6	1	1	3	6	8	14	19	30	40	52
	4	1	1	3	5	6	11	15	23	31	41
	3	1	1	2	4	6	9	13	21	28	36
	2	1	1	1	3	5	8	11	18	24	31
	1	0	1	1	2	3	5	7	12	16	20
	1/0	0	1	1	1	3	4	6	10	14	18
	2/0	0	1	1	1	2	4	6	9	12	15
	3/0	0	0	1	1	1	3	5	7	10	13
	4/0	0	0	1	1	1	3	4	6	9	11
	250	0	0	1	1	1	1	3	5	6	8
	300	0	0	0	1	1	1	3	4	6	7
	350	0	0	0	1	1	1	2	4	5	7
	400	0	0	0	1	1	1	2	3	5	6
	500	0	0	0	1	1	1	1	3	4	5
	600	0	0	0	0	1	1	1	2	3	4
	700	0	0	0	0	1	1	1	2	3	4
	750	0	0	0	0	1	1	1	1	3	4
	800	0	0	0	0	0	1	1	1	3	3
	900	0	0	0	0	0	1	1	1	2	3
	1000	0	0	0	0	0	1	1	1	2	3
	1250	0	0	0	0	0	1	1	1	1	2
	1500	0	0	0	0	0	0	1	1	1	1
	1750	0	0	0	0	0	0	1	1	1	1
	2000	0	0	0	0	0	0	1	1	1	1
TW, THHW, THW, THW-2	14	10	17	27	47	64	104	147	228	304	392
TW, THHW, THW, THW-2	12	7	13	21	36	49	80	113	175	234	301
TW, THHW, THW, THW-2	10	5	9	15	27	36	59	84	130	174	224
TW, THHW, THW, THW-2	8	3	5	8	15	20	33	47	72	97	124
RHH*, RHW*, RHW-2	14	6	11	18	31	42	69	98	151	202	261
RHH*, RHW*, RHW-2	12	5	9	14	25	34	56	79	122	163	209
RHH*, RHW*, RHW-2	10	4	7	11	19	26	43	61	95	127	163
RHH*, RHW*, RHW-2	8	2	4	7	12	16	26	37	57	76	98
RHH*, RHW*, RHW-2	6	1	3	5	9	12	20	28	43	58	75
RHH*, RHW*, RHW-2	4	1	2	4	6	9	15	21	32	43	56
TW, THHW, THW, THW-2	3	1	1	3	6	8	13	18	28	37	48
TW, THHW, THW, THW-2	2	1	1	3	5	6	11	15	23	31	41
TW, THHW, THW, THW-2	1	1	1	1	3	4	7	11	16	22	28
	1/0	1	1	1	3	4	6	9	14	19	24
	2/0	0	1	1	2	3	5	8	12	16	20
	3/0	0	1	1	1	3	4	6	10	13	17
	4/0	0	1	1	1	2	4	5	8	11	14
	250	0	0	1	1	1	3	4	7	9	12
	300	0	0	1	1	1	2	4	6	8	10
	350	0	0	1	1	1	2	3	5	7	9
	400	0	0	0	1	1	1	3	4	6	8
	500	0	0	0	1	1	1	2	4	5	7
	600	0	0	0	1	1	1	1	3	4	5
	700	0	0	0	1	1	1	1	3	4	5
	750	0	0	0	0	1	1	1	2	3	4
	800	0	0	0	0	1	1	1	2	3	4
	900	0	0	0	0	1	1	1	2	3	4
	1000	0	0	0	0	0	1	1	1	3	3
	1250	0	0	0	0	0	1	1	1	1	3
	1500	0	0	0	0	0	1	1	1	1	2
	1750	0	0	0	0	0	0	1	1	1	1
	2000	0	0	0	0	0	0	1	1	1	1

(continued)

TABLE 2.23 NEC Table C4: Maximum Number of Conductors or Fixture Wires in Intermediate Metal Conduit (*Continued*)

CONDUCTORS											
Type	Conductor Size (AWG/kcmil)	Metric Designator (Trade Size)									
		16 (½)	21 (¾)	27 (1)	35 (1¼)	41 (1½)	53 (2)	63 (2½)	78 (3)	91 (3½)	103 (4)
THHN, THWN, THWN-2	14	14	24	39	68	91	149	211	326	436	562
	12	10	17	29	49	67	109	154	238	318	410
	10	6	11	18	31	42	68	97	150	200	258
	8	3	6	10	18	24	39	56	86	115	149
	6	2	4	7	13	17	28	40	62	83	107
	4	1	3	4	8	10	17	25	38	51	66
	3	1	2	4	6	9	15	21	32	43	56
	2	1	1	3	5	7	12	17	27	36	47
	1	1	1	2	4	5	9	13	20	27	35
	1/0	1	1	1	3	4	8	11	17	23	29
	2/0	1	1	1	3	4	6	9	14	19	24
	3/0	0	1	1	2	3	5	7	12	16	20
	4/0	0	1	1	1	2	4	6	9	13	17
	250	0	0	1	1	1	3	5	8	10	13
	300	0	0	1	1	1	3	4	7	9	12
350	0	0	1	1	1	2	4	6	8	10	
400	0	0	1	1	1	2	3	5	7	9	
500	0	0	0	1	1	1	3	4	6	7	
600	0	0	0	1	1	1	2	3	5	6	
700	0	0	0	1	1	1	1	3	4	5	
750	0	0	0	1	1	1	1	3	4	5	
800	0	0	0	0	1	1	1	3	4	5	
900	0	0	0	0	1	1	1	2	3	4	
1000	0	0	0	0	1	1	1	2	3	4	
FEP, FEPB, PFA, PFAH, TFE	14	13	23	38	66	89	145	205	317	423	545
12	10	17	28	48	65	106	150	231	309	398	
10	7	12	20	34	46	76	107	166	221	285	
8	4	7	11	19	26	43	61	95	127	163	
6	3	5	8	14	19	31	44	67	90	116	
4	1	3	5	10	13	21	30	47	63	81	
3	1	3	4	8	11	18	25	39	52	68	
2	1	2	4	6	9	15	21	32	43	56	
1	1	1	2	4	6	10	14	22	30	39	
PFA, PFAH, TFE	1/0	1	1	1	4	5	8	12	19	25	32
PFA, PFAH, TFE, Z	2/0	1	1	1	3	4	7	10	15	21	27
3/0	0	1	1	2	3	6	8	13	17	22	
4/0	0	1	1	1	3	5	7	10	14	18	
Z	14	16	28	46	79	107	175	247	381	510	657
12	11	20	32	56	76	124	175	271	362	466	
10	7	12	20	34	46	76	107	166	221	285	
8	4	7	12	21	29	48	68	105	140	180	
6	3	5	9	15	20	33	47	73	98	127	
4	1	3	6	10	14	23	33	50	67	87	
3	1	2	4	7	10	17	24	37	49	63	
2	1	1	3	6	8	14	20	30	41	53	
1	1	1	3	5	7	11	16	25	33	43	
XHH, XHHW, XHHW-2, ZW	14	10	17	27	47	64	104	147	228	304	392
12	7	13	21	36	49	80	113	175	234	301	
10	5	9	15	27	36	59	84	130	174	224	
8	3	5	8	15	20	33	47	72	97	124	
6	1	4	6	11	15	24	35	53	71	92	
4	1	3	4	8	11	18	25	39	52	67	
3	1	2	4	7	9	15	21	33	44	56	
2	1	1	3	5	7	12	18	27	37	47	
XHH, XHHW, XHHW-2	1	1	1	2	4	5	9	13	20	27	35
1/0	1	1	1	3	5	8	11	17	23	30	
2/0	1	1	1	3	4	6	9	14	19	25	
3/0	0	1	1	2	3	5	7	12	16	20	
4/0	0	1	1	1	2	4	6	10	13	17	
250	0	0	1	1	1	3	5	8	11	14	
300	0	0	1	1	1	3	4	7	9	12	
350	0	0	1	1	1	3	4	6	8	10	
400	0	0	1	1	1	2	3	5	7	9	
500	0	0	0	1	1	1	3	4	6	8	
600	0	0	0	1	1	1	2	3	5	6	
700	0	0	0	1	1	1	1	3	4	5	
750	0	0	0	1	1	1	1	3	4	5	
800	0	0	0	0	1	1	1	3	4	5	
900	0	0	0	0	1	1	1	2	3	4	
1000	0	0	0	0	1	1	1	2	3	4	
1250	0	0	0	0	0	1	1	1	2	3	
1500	0	0	0	0	0	1	1	1	1	2	
1750	0	0	0	0	0	1	1	1	1	2	
2000	0	0	0	0	0	0	1	1	1	1	

(continued)

TABLE 2.23 NEC Table C4: Maximum Number of Conductors or Fixture Wires in Intermediate Metal Conduit (*Continued*)

FIXTURE WIRES							
Type	Conductor Size (AWG/kcmil)	Metric Designator (Trade Size)					
		16 (½)	21 (¾)	27 (1)	35 (1¼)	41 (1½)	53 (2)
FHH-2, RFH-2, RFHH-3	18	9	16	26	45	61	100
	16	8	13	22	38	51	84
SF-2, SFF-2	18	12	20	33	57	77	126
	16	10	17	27	47	64	104
	14	8	13	22	38	51	84
SF-1, SFF-1	18	21	36	59	101	137	223
RFH-1, RFHH-2, TF, TFF, XF, XFF	18	15	26	43	75	101	165
RFH-2, TF, TFF, XF, XFF	16	12	21	35	60	81	133
XF, XFF	14	10	17	27	47	64	104
TFN, TFFN	18	25	42	69	119	161	264
	16	19	32	53	91	123	201
PF, PFF, PGF, PGFF, PAF, PTF, PTFE, PAFF	18	23	40	66	113	153	250
	16	18	31	51	87	118	193
	14	13	23	38	66	89	145
ZF, ZFF, ZHF, HF, HFF	18	30	52	85	146	197	322
	16	22	38	63	108	145	238
	14	16	28	46	79	107	175
KF-2, KFF-2	18	44	75	123	212	287	468
	16	31	53	87	149	202	330
	14	21	36	60	103	139	227
	12	14	25	41	70	95	156
	10	10	17	27	47	64	104
KF-1, KFF-1	18	52	90	147	253	342	558
	16	37	63	103	178	240	392
	14	25	42	69	119	161	264
	12	16	28	46	79	107	175
	10	10	18	30	52	70	114
XF, XFF	12	5	9	14	25	34	56
	10	4	7	11	19	26	43

Note: This table is for concentric stranded conductors only. For compact stranded conductors, Table C4(A) should be used.

*Types RHH, RHW, and RHW-2 without outer covering.

(© 2001, NFPA)

TABLE 2.24 NEC Table C5: Maximum Number of Conductors or Fixture Wires in Liquidtight Flexible Nonmetallic Conduit (Type LFNC-B*)

CONDUCTORS								
Type	Conductor Size (AWG/kcmil)	Metric Designator (Trade Size)						
		12 (¾)	16 (½)	21 (⅔)	27 (1)	35 (1¼)	41 (1½)	53 (2)
RHH, RHW, RHW-2	14	2	4	7	12	21	27	44
	12	1	3	6	10	17	22	36
RHH, RHW, RHW-2	10	1	3	5	8	14	18	29
	8	1	1	2	4	7	9	15
RHH, RHW, RHW-2	6	1	1	1	3	6	7	12
	4	0	1	1	2	4	6	9
RHH, RHW, RHW-2	3	0	1	1	1	4	5	8
	2	0	1	1	1	3	4	7
RHH, RHW, RHW-2	1	0	0	1	1	1	3	5
	1/0	0	0	1	1	1	2	4
RHH, RHW, RHW-2	2/0	0	0	1	1	1	1	3
	3/0	0	0	0	1	1	1	3
RHH, RHW, RHW-2	4/0	0	0	0	1	1	1	2
	250	0	0	0	0	1	1	1
RHH, RHW, RHW-2	300	0	0	0	0	1	1	1
	350	0	0	0	0	1	1	1
RHH, RHW, RHW-2	400	0	0	0	0	1	1	1
	500	0	0	0	0	1	1	1
RHH, RHW, RHW-2	600	0	0	0	0	0	1	1
	700	0	0	0	0	0	0	1
RHH, RHW, RHW-2	750	0	0	0	0	0	0	1
	800	0	0	0	0	0	0	1
RHH, RHW, RHW-2	900	0	0	0	0	0	0	1
	1000	0	0	0	0	0	0	1
RHH, RHW, RHW-2	1250	0	0	0	0	0	0	0
	1500	0	0	0	0	0	0	0
RHH, RHW, RHW-2	1750	0	0	0	0	0	0	0
	2000	0	0	0	0	0	0	0
TW, THHW, THW, THW-2	14	5	9	15	25	44	57	93
	12	4	7	12	19	33	43	71
TW, THHW, THW, THW-2	10	3	5	9	14	25	32	53
	8	1	3	5	8	14	18	29

(continued)

TABLE 2.24 NEC Table C5: Maximum Number of Conductors or Fixture Wires in Liquidtight Flexible Nonmetallic Conduit (Type LFNC-B*)
(Continued)

CONDUCTORS								
Type	Conductor Size (AWG/kcmil)	Metric Designator (Trade Size)						
		12 (%)	16 (%)	21 (%)	27 (1)	35 (1½)	41 (1½)	53 (2)
RHH [†] , RHW [†] , RHW-2 [†]	14	3	6	10	16	29	38	62
RHH [†] , RHW [†] , RHW-2 [†]	12	3	5	8	13	23	30	50
RHH [†] , RHW [†] , RHW-2 [†]	10	1	3	6	10	18	23	39
RHH [†] , RHW [†] , RHW-2 [†]	8	1	1	4	6	11	14	23
RHH [†] , RHW [†] , RHW-2 [†]	6	1	1	3	5	8	11	18
RHW [†] , RHW-2 [†] , TW, THW,	4	1	1	1	3	6	8	13
	3	1	1	1	3	5	7	11
THHW, THW-2	2	0	1	1	2	4	6	9
	1	0	1	1	1	3	4	7
	1/0	0	0	1	1	2	3	6
	2/0	0	0	1	1	2	3	5
	3/0	0	0	1	1	1	2	4
	4/0	0	0	0	1	1	1	3
	250	0	0	0	1	1	1	3
	300	0	0	0	1	1	1	2
	350	0	0	0	0	1	1	1
	400	0	0	0	0	1	1	1
	500	0	0	0	0	1	1	1
	600	0	0	0	0	1	1	1
	700	0	0	0	0	0	1	1
	750	0	0	0	0	0	1	1
	800	0	0	0	0	0	1	1
	900	0	0	0	0	0	0	1
	1000	0	0	0	0	0	0	1
	1250	0	0	0	0	0	0	1
	1500	0	0	0	0	0	0	0
	1750	0	0	0	0	0	0	0
	2000	0	0	0	0	0	0	0
THHN, THWN, THWN-2	14	8	13	22	36	63	81	133
	12	5	9	16	26	46	59	97
	10	3	6	10	16	29	37	61
	8	1	3	6	9	16	21	35
	6	1	2	4	7	12	15	25
	4	1	1	2	4	7	9	15
	3	1	1	1	3	6	8	13
	2	1	1	1	3	5	7	11
	1	0	1	1	1	4	5	8
	1/0	0	1	1	1	3	4	7
	2/0	0	0	1	1	2	3	6
	3/0	0	0	1	1	1	3	5
	4/0	0	0	1	1	1	2	4
	250	0	0	0	1	1	1	3
	300	0	0	0	1	1	1	3
	350	0	0	0	1	1	1	2
	400	0	0	0	0	1	1	1
	500	0	0	0	0	1	1	1
	600	0	0	0	0	1	1	1
	700	0	0	0	0	1	1	1
	750	0	0	0	0	0	1	1
	800	0	0	0	0	0	1	1
	900	0	0	0	0	0	1	1
	1000	0	0	0	0	0	0	1
FEP, FEPB, PFA, PFAH, TFE	14	7	12	21	35	61	79	129
	12	5	9	15	25	44	57	94
	10	4	6	11	18	32	41	68
	8	1	3	6	10	18	23	39
	6	1	2	4	7	13	17	27
	4	1	1	3	5	9	12	19
	3	1	1	2	4	7	10	16
	2	1	1	1	3	6	8	13
PFA, PFAH, TFE	1	0	1	1	2	4	5	9
PFA, PFAH, TFE, Z	1/0	0	1	1	1	3	4	7
	2/0	0	1	1	1	3	4	6
	3/0	0	0	1	1	2	3	5
	4/0	0	0	1	1	1	2	4
Z	14	9	15	26	42	73	95	156
	12	6	10	18	30	52	67	111
	10	4	6	11	18	32	41	68
	8	2	4	7	11	20	26	43
	6	1	3	5	8	14	18	30
	4	1	1	3	5	9	12	20
	3	1	1	2	4	7	9	15
	2	0	1	1	3	6	7	12
	1	0	1	1	2	5	6	10

(continued)

TABLE 2.24 NEC Table C5: Maximum Number of Conductors or Fixture Wires in Liquidtight Flexible Nonmetallic Conduit (Type LFNC-B*) (*Continued*)

CONDUCTORS								
Type	Conductor Size (AWG/kcmil)	Metric Designator (Trade Size)						
		12 (¾)	16 (½)	21 (¼)	27 (1)	35 (1¼)	41 (1½)	53 (2)
XHH,	14	5	9	15	25	44	57	93
XHHW,	12	4	7	12	19	33	43	71
XHHW-2,	10	3	5	9	14	25	32	53
ZW	8	1	3	5	8	14	18	29
	6	1	1	3	6	10	13	22
XHH,	4	1	1	2	4	7	9	16
XHHW,	3	1	1	1	3	6	8	13
XHHW-2,	2	1	1	1	3	5	7	11
ZW								
XHH,	1	0	1	1	1	4	5	8
XHHW,	1/0	0	1	1	1	3	4	7
XHHW-2	2/0	0	0	1	1	2	3	6
	3/0	0	0	1	1	1	3	5
	4/0	0	0	1	1	1	2	4
	250	0	0	0	1	1	1	3
	300	0	0	0	1	1	1	3
	350	0	0	0	1	1	1	2
	400	0	0	0	0	1	1	1
	500	0	0	0	0	1	1	1
	600	0	0	0	0	1	1	1
	700	0	0	0	0	1	1	1
	750	0	0	0	0	0	1	1
	800	0	0	0	0	0	1	1
	900	0	0	0	0	0	1	1
	1000	0	0	0	0	0	0	1
	1250	0	0	0	0	0	0	1
	1500	0	0	0	0	0	0	1
	1750	0	0	0	0	0	0	0
	2000	0	0	0	0	0	0	0
FIXTURE WIRES								
FFH-2,	18	5	8	15	24	42	54	89
RFH-2	16	4	7	12	20	35	46	75
SF-2, SFF-2	18	6	11	19	30	53	69	113
	16	5	9	15	25	44	57	93
	14	4	7	12	20	35	46	75
SF-1, SFF-1	18	11	19	33	53	94	122	199
RFH-1,	18	8	14	24	39	69	90	147
RFHH-2, TF,								
TF, XF,								
XFF								
RFHH-2, TF,	16	7	11	20	32	56	72	119
TF, XF,								
XFF								
XF, XFF	14	5	9	15	25	44	57	93
TFN, TFFN	18	14	23	39	63	111	144	236
	16	10	17	30	48	85	110	180
PF, PFF	18	13	21	37	60	105	136	223
PGF, PGFF,	16	10	16	29	46	81	105	173
PAF, PTF,	14	7	12	21	35	61	79	129
PTFF, PAFF								
HF, HFF, ZF,	18	17	28	48	77	136	176	288
ZFF, ZHF	16	12	20	35	57	100	129	212
	14	9	15	26	42	73	95	156
KF-2, KFF-2	18	24	40	70	112	197	255	418
	16	17	28	49	79	139	180	295
	14	12	19	34	54	95	123	202
	12	8	13	23	37	65	85	139
	10	5	9	15	25	44	57	93
KF-1, KFF-1	18	29	48	83	134	235	304	499
	16	20	34	58	94	165	214	350
	14	14	23	39	63	111	144	236
	12	9	15	26	42	73	95	156
	10	6	10	17	27	48	62	102
XF, XFF	12	3	5	8	13	23	30	50
	10	1	3	6	10	18	23	39

Note: This table is for concentric stranded conductors only. For compact stranded conductors, Table C5(A), should be used.

*Corresponds to 356.2(2).

†Types RHH, RHW, and RHW-2 without outer covering.

(© 2001, NFPA)

TABLE 2.25 NEC Table C6: Maximum Number of Conductors or Fixture Wires in Liquidtight Flexible Nonmetallic Conduit (Type LFNC-A*)

		CONDUCTORS						
		Metric Designator (Trade Size)						
Type	Conductor Size (AWG/kcmil)	12 (%)	16 (½)	21 (%)	27 (1)	35 (1½)	41 (1½)	53 (2)
RHH, RHW, RHW-2	14	2	4	7	11	20	27	45
	12	1	3	6	9	17	23	38
	10	1	3	5	8	13	18	30
	8	1	1	2	4	7	9	16
	6	1	1	1	3	5	7	13
	4	0	1	1	2	4	6	10
	3	0	1	1	1	4	5	8
	2	0	1	1	1	3	4	7
	1	0	0	1	1	1	3	5
	1/0	0	0	1	1	1	2	4
	2/0	0	0	1	1	1	1	4
	3/0	0	0	0	1	1	1	3
	4/0	0	0	0	1	1	1	3
	250	0	0	0	0	1	1	1
	300	0	0	0	0	1	1	1
	350	0	0	0	0	1	1	1
	400	0	0	0	0	1	1	1
	500	0	0	0	0	0	1	1
	600	0	0	0	0	0	1	1
	700	0	0	0	0	0	0	1
750	0	0	0	0	0	0	1	
800	0	0	0	0	0	0	1	
900	0	0	0	0	0	0	1	
1000	0	0	0	0	0	0	1	
1250	0	0	0	0	0	0	0	
1500	0	0	0	0	0	0	0	
1750	0	0	0	0	0	0	0	
2000	0	0	0	0	0	0	0	
TW, THHW, THW, THW-2	14	5	9	15	24	43	58	96
	12	4	7	12	19	33	44	74
	10	3	5	9	14	24	33	55
	8	1	3	5	8	13	18	30
RHH ¹ , RHW ¹ , RHW-2 ¹	14	3	6	10	16	28	38	64
	12	3	4	8	13	23	31	51
	10	1	3	6	10	18	24	40
	8	1	1	4	6	10	14	24
RHH ¹ , RHW ¹ , RHW-2 ¹ , TW, THW, THHW, THW-2	6	1	1	3	4	8	11	18
	4	1	1	1	3	6	8	13
	3	1	1	1	3	5	7	11
	2	0	1	1	2	4	6	10
	1	0	1	1	1	3	4	7
	1/0	0	0	1	1	2	3	6
	2/0	0	0	1	1	1	3	5
	3/0	0	0	1	1	1	2	4
	4/0	0	0	0	1	1	1	3
	250	0	0	0	1	1	1	3
	300	0	0	0	1	1	1	2
350	0	0	0	0	1	1	1	
400	0	0	0	0	1	1	1	
500	0	0	0	0	1	1	1	
600	0	0	0	0	1	1	1	
700	0	0	0	0	0	1	1	
750	0	0	0	0	0	1	1	
800	0	0	0	0	0	1	1	
900	0	0	0	0	0	0	1	
1000	0	0	0	0	0	0	1	
1250	0	0	0	0	0	0	1	
1500	0	0	0	0	0	0	1	
1750	0	0	0	0	0	0	0	
2000	0	0	0	0	0	0	0	

(continued)

TABLE 2.25 NEC Table C6: Maximum Number of Conductors or Fixture Wires in Liquidtight Flexible Nonmetallic Conduit (Type LFNC-A*)
(Continued)

CONDUCTORS								
Type	Conductor Size (AWG/kcmil)	Metric Designator (Trade Size)						
		12 (3/4)	16 (1 1/4)	21 (1 3/4)	27 (1)	35 (1 1/4)	41 (1 1/2)	53 (2)
THHN, THWN, THWN-2	14	8	13	22	35	62	83	137
	12	5	9	16	25	45	60	100
	10	3	6	10	16	28	38	63
	8	1	3	6	9	16	22	36
	6	1	2	4	6	12	16	26
	4	1	1	2	4	7	9	16
	3	1	1	1	3	6	8	13
	2	1	1	1	3	5	7	11
	1	0	1	1	1	4	5	8
	1/0	0	1	1	1	3	4	7
	2/0	0	0	1	1	2	3	6
	3/0	0	0	1	1	1	3	5
	4/0	0	0	1	1	1	2	4
	250	0	0	0	1	1	1	3
	300	0	0	0	1	1	1	3
350	0	0	0	1	1	1	2	
400	0	0	0	0	0	1	1	
500	0	0	0	0	1	1	1	
600	0	0	0	0	1	1	1	
700	0	0	0	0	1	1	1	
750	0	0	0	0	0	1	1	
800	0	0	0	0	0	1	1	
900	0	0	0	0	0	1	1	
1000	0	0	0	0	0	0	1	
FEP, FEPB, PFA, PFAH, TFE	14	7	12	21	34	60	80	133
	12	5	9	15	25	44	59	97
	10	4	6	11	18	31	42	70
	8	1	3	6	10	18	24	40
	6	1	2	4	7	13	17	28
	4	1	1	3	5	9	12	20
	3	1	1	2	4	7	10	16
2	1	1	1	3	6	8	13	
PFA, PFAH, TFE	1	0	1	1	2	4	5	9
	1/0	0	1	1	1	3	5	8
	2/0	0	1	1	1	3	4	6
	3/0	0	0	1	1	2	3	5
Z	4/0	0	0	1	1	1	2	4
	14	9	15	25	41	72	97	161
	12	6	10	18	29	51	69	114
	10	4	6	11	18	31	42	70
	8	2	4	7	11	20	26	44
	6	1	3	5	8	14	18	31
	4	1	1	3	5	9	13	21
3	1	1	2	4	7	9	15	
2	1	1	1	3	6	8	13	
1	1	1	1	2	4	6	10	
XHH, XHHW, XHHW-2, ZW	14	5	9	15	24	43	58	96
	12	4	7	12	19	33	44	74
	10	3	5	9	14	24	33	55
	8	1	3	5	8	13	18	30
	6	1	1	3	5	10	13	22
	4	1	1	2	4	7	10	16
	3	1	1	1	3	6	8	14
2	1	1	1	3	5	7	11	
XHH, XHHW, XHHW-2	1	0	1	1	1	4	5	8
	1/0	0	1	1	1	3	4	7
	2/0	0	0	1	1	2	3	6
	3/0	0	0	1	1	1	3	5
	4/0	0	0	1	1	1	2	4
	250	0	0	0	1	1	1	3
	300	0	0	0	1	1	1	3
	350	0	0	0	1	1	1	2
	400	0	0	0	0	1	1	1
	500	0	0	0	0	1	1	1
	600	0	0	0	0	1	1	1
	700	0	0	0	0	1	1	1
	750	0	0	0	0	0	1	1
	800	0	0	0	0	0	1	1
	900	0	0	0	0	0	1	1
1000	0	0	0	0	0	0	1	
1250	0	0	0	0	0	0	1	
1500	0	0	0	0	0	0	1	
1750	0	0	0	0	0	0	0	
2000	0	0	0	0	0	0	0	
FIXTURE WIRES								
FFH-2	18	5	8	14	23	41	55	92
RFH-2	16	4	7	12	20	35	47	77
RFHH-3	16	4	7	12	20	35	47	77
SF-2, SFF-2	18	6	11	18	29	52	70	116
	16	5	9	15	24	43	58	96
	14	4	7	12	20	35	47	77

(continued)

TABLE 2.25 NEC Table C6: Maximum Number of Conductors or Fixture Wires in Liquidtight Flexible Nonmetallic Conduit (Type LFNC-A*) (*Continued*)

CONDUCTORS								
Type	Conductor Size (AWG/kcmil)	Metric Designator (Trade Size)						
		12 (%)	16 (%)	21 (%)	27 (1) (1¼)	35 (1½)	41 (1½)	53 (2)
SF-1, SFF-1	18	12	19	33	52	92	124	205
RFH-1, RFHH-2, TF, TFE, XF, XFF	18	8	14	24	39	68	91	152
RFHH-2, TF, TFE, XF, XFF	16	7	11	19	31	55	74	122
XF, XFF	14	5	9	15	24	43	58	96
TFN, TFFN	18	14	22	39	62	109	146	243
	16	10	17	29	47	83	112	185
PF, PFF, PGF, PGFF, PAF, PTR, PTFE, PAFF	18	13	21	37	59	103	139	230
	16	10	16	28	45	80	107	178
	14	7	12	21	34	60	80	133
HF, HFF, ZF, ZFF, ZHF	18	17	27	47	76	133	179	297
	16	12	20	35	56	98	132	219
	14	9	15	25	41	72	97	161
KF-2, KFF-2	18	25	40	69	110	193	260	431
	16	17	28	48	77	136	183	303
	14	12	19	33	53	94	126	209
	12	8	13	23	36	64	86	143
	10	5	9	15	24	43	58	96
KF-1, KFF-1	18	29	48	82	131	231	310	514
	16	21	33	57	92	162	218	361
	14	14	22	39	62	109	146	243
	12	9	15	25	41	72	97	161
	10	6	10	17	27	47	63	105
XF, XFF	12	3	4	8	13	23	31	51
	10	1	3	6	10	18	24	40

Note: This table is for concentric stranded conductors only. For compact stranded conductors, Table C6(A) should be used.

*Corresponds to 356.2(1).

†Types RHH, RHW, and RHW-2 without outer covering.

(© 2001, NFPA)

TABLE 2.26 NEC Table C7: Maximum Number of Conductors or Fixture Wires in Liquidtight Flexible Metal Conduit (LFMC)

CONDUCTORS											
Type	Conductor Size (AWG/kcmil)	Metric Designator (Trade Size)									
		16 (½)	21(¾)	27 (1)	35 (1¼)	41 (1½)	53 (2)	63 (2½)	78 (3)	91 (3¾)	103 (4)
RHH, RHW, RHW-2	14	4	7	12	21	27	44	66	102	133	175
	12	3	6	10	17	22	36	55	84	110	144
	10	3	5	8	14	18	29	44	68	89	116
	8	1	2	4	7	9	15	23	36	46	61
	6	1	1	3	6	7	12	18	28	37	48
	4	1	1	2	4	6	9	14	22	29	38
	3	1	1	1	4	5	8	13	19	25	33
	2	1	1	1	3	4	7	11	17	22	29
	1	0	1	1	1	3	5	7	11	14	19
	1/0	0	1	1	1	2	4	6	10	13	16
	2/0	0	1	1	1	1	3	5	8	11	14
	3/0	0	0	1	1	1	3	4	7	9	12
	4/0	0	0	1	1	1	2	4	6	8	10
	250	0	0	0	1	1	1	3	4	6	8
	300	0	0	0	1	1	1	2	4	5	7
	350	0	0	0	1	1	1	2	3	5	6
	400	0	0	0	1	1	1	1	3	4	6
	500	0	0	0	1	1	1	1	3	4	5
	600	0	0	0	0	1	1	1	2	3	4
	700	0	0	0	0	0	1	1	1	3	3
750	0	0	0	0	0	1	1	1	2	3	
800	0	0	0	0	0	1	1	1	2	3	
900	0	0	0	0	0	1	1	1	2	3	
1000	0	0	0	0	0	1	1	1	1	3	
1250	0	0	0	0	0	0	1	1	1	1	
1500	0	0	0	0	0	0	1	1	1	1	
1750	0	0	0	0	0	0	1	1	1	1	
2000	0	0	0	0	0	0	0	1	1	1	
TW,	14	9	15	25	44	57	93	140	215	280	365
THHW,	12	7	12	19	33	43	71	108	165	215	280
THW,	10	5	9	14	25	32	53	80	123	160	209
THW-2	8	3	5	8	14	18	29	44	68	89	116
RHH*, RHW*, RHW-2*	14	6	10	16	29	38	62	93	143	186	243

(continued)

TABLE 2.26 NEC Table C7: Maximum Number of Conductors or Fixture Wires in Liquidtight Flexible Metal Conduit (LFMC) (Continued)

		CONDUCTORS									
Type	Conductor Size (AWG/kcmil)	Metric Designator (Trade Size)									
		16 (½)	21 (¾)	27 (1)	35 (1½)	41 (1½)	53 (2)	63 (2½)	78 (3)	91 (3½)	103 (4)
RHH*	12	5	8	13	23	30	50	75	115	149	195
RHW*	10	3	6	10	18	23	39	58	89	117	152
RHW-2*	8	1	4	6	11	14	23	35	53	70	91
RHH*	6	1	3	5	8	11	18	27	41	53	70
RHW*	4	1	1	3	6	8	13	20	30	40	52
RHW-2*	3	1	1	3	5	7	11	17	26	34	44
TW, THW,	2	1	1	2	4	6	9	14	22	29	38
THHW,	1	1	1	1	3	4	7	10	15	20	26
THW-2	1/0	0	1	1	2	3	6	8	13	17	23
	2/0	0	1	1	2	3	5	7	11	15	19
	3/0	0	1	1	1	2	4	6	9	12	16
	4/0	0	0	1	1	1	3	5	8	10	13
	250	0	0	1	1	1	3	4	6	8	11
	300	0	0	1	1	1	2	3	5	7	9
	350	0	0	0	1	1	1	3	5	6	8
	400	0	0	0	1	1	1	3	4	6	7
	500	0	0	0	1	1	1	2	3	5	6
	600	0	0	0	1	1	1	1	3	4	5
	700	0	0	0	0	1	1	1	2	3	4
	750	0	0	0	0	1	1	1	2	3	4
	800	0	0	0	0	1	1	1	2	3	4
	900	0	0	0	0	0	1	1	1	3	3
	1000	0	0	0	0	0	1	1	1	2	3
	1250	0	0	0	0	0	1	1	1	1	2
	1500	0	0	0	0	0	0	1	1	1	2
	1750	0	0	0	0	0	0	1	1	1	1
	2000	0	0	0	0	0	0	1	1	1	1
THHN,	14	13	22	36	63	81	133	201	308	401	523
THWN,	12	9	16	26	46	59	97	146	225	292	381
THWN-2	10	6	10	16	29	37	61	92	141	184	240
	8	3	6	9	16	21	35	53	81	106	138
	6	2	4	7	12	15	25	38	59	76	100
	4	1	2	4	7	9	15	23	36	47	61
	3	1	1	3	6	8	13	20	30	40	52
	2	1	1	3	5	7	11	17	26	33	44
	1	1	1	1	4	5	8	12	19	25	32
	1/0	1	1	1	3	4	7	10	16	21	27
	2/0	0	1	1	2	3	6	8	13	17	23
	3/0	0	1	1	1	3	5	7	11	14	19
	4/0	0	1	1	1	2	4	6	9	12	15
	250	0	0	1	1	1	3	5	7	10	12
	300	0	0	1	1	1	3	4	6	8	11
	350	0	0	1	1	1	2	3	5	7	9
	400	0	0	0	1	1	1	3	5	6	8
	500	0	0	0	1	1	1	2	4	5	7
	600	0	0	0	1	1	1	1	3	4	6
	700	0	0	0	1	1	1	1	3	4	5
	750	0	0	0	0	1	1	1	3	3	5
	800	0	0	0	0	1	1	1	2	3	4
	900	0	0	0	0	1	1	1	2	3	4
	1000	0	0	0	0	0	1	1	1	3	3
FEP,	14	12	21	35	61	79	129	195	299	389	507
FEPB,	12	9	15	25	44	57	94	142	218	284	370
PFA,	10	6	11	18	32	41	68	102	156	203	266
PFAH,	8	3	6	10	18	23	39	58	89	117	152
TFE	6	2	4	7	13	17	27	41	64	83	108
	4	1	3	5	9	12	19	29	44	58	75
	3	1	2	4	7	10	16	24	37	48	63
	2	1	1	3	6	8	13	20	30	40	52
PFA,	1	1	1	2	4	5	9	14	21	28	36
PFAH,											
TFE											
PFA,	1/0	1	1	1	3	4	7	11	18	23	30
PFAH,	2/0	1	1	1	3	4	6	9	14	19	25
TFE, Z	3/0	0	1	1	2	3	5	8	12	16	20
	4/0	0	1	1	1	2	4	6	10	13	17
Z	14	20	26	42	73	95	156	235	360	469	611
	12	14	18	30	52	67	111	167	255	332	434
	10	8	11	18	32	41	68	102	156	203	266
	8	5	7	11	20	26	43	64	99	129	168
	6	4	5	8	14	18	30	45	69	90	118
	4	2	3	5	9	12	20	31	48	62	81
	3	2	2	4	7	9	15	23	35	45	59
	2	1	1	3	6	7	12	19	29	38	49
	1	1	1	2	5	6	10	15	23	30	40

(continued)

TABLE 2.26 NEC Table C7: Maximum Number of Conductors or Fixture Wires in Liquidtight Flexible Metal Conduit (LFMC) (*Continued*)

CONDUCTORS											
Type	Conductor Size (AWG/kcmil)	Metric Designator (Trade Size)									
		16 (½)	21 (¾)	27 (1)	35 (1¼)	41 (1½)	53 (2)	63 (2½)	78 (3)	91 (3¾)	103 (4)
XHH,	14	9	15	25	44	57	93	140	215	280	365
XHHW,	12	7	12	19	33	43	71	108	165	215	280
XHHW-2,	10	5	9	14	25	32	53	80	123	160	209
ZW	8	3	5	8	14	18	29	44	68	89	116
	6	1	3	6	10	13	22	33	50	66	86
	4	1	2	4	7	9	16	24	36	48	62
	3	1	1	3	6	8	13	20	31	40	52
	2	1	1	3	5	7	11	17	26	34	44
XHH,	1	1	1	1	4	5	8	12	19	25	33
XHHW,	1/0	1	1	1	3	4	7	10	16	21	28
XHHW-2	2/0	0	1	1	2	3	6	9	13	17	23
	3/0	0	1	1	1	3	5	7	11	14	19
	4/0	0	1	1	1	2	4	6	9	12	16
	250	0	0	1	1	1	3	5	7	10	13
	300	0	0	1	1	1	3	4	6	8	11
	350	0	0	1	1	1	2	3	5	7	10
	400	0	0	0	1	1	1	3	5	6	8
	500	0	0	0	1	1	1	2	4	5	7
	600	0	0	0	1	1	1	1	3	4	6
	700	0	0	0	1	1	1	1	3	4	5
	750	0	0	0	1	1	1	1	3	3	5
	800	0	0	0	0	1	1	1	2	3	4
	900	0	0	0	0	1	1	1	2	3	4
	1000	0	0	0	0	0	1	1	1	3	3
	1250	0	0	0	0	0	1	1	1	1	3
	1500	0	0	0	0	0	1	1	1	1	2
	1750	0	0	0	0	0	0	1	1	1	2
	2000	0	0	0	0	0	0	1	1	1	2

*Types RHH, RHW, and RHW-2 without outer covering.

FLXTURE WIRES							
Type	Conductor Size (AWG/kcmil)	Metric Designator (Trade Size)					
		16 (½)	21 (¾)	27 (1)	35 (1¼)	41 (1½)	53 (2)
FFH-2,	18	8	15	24	42	54	89
RFH-2,	16	7	12	20	35	46	75
RFHH-3							
SF-2, SFF-2	18	11	19	30	53	69	113
	16	9	15	25	44	57	93
	14	7	12	20	35	46	75
SP-1, SFF-1	18	19	33	53	94	122	199
RFH-1,	18	14	24	39	69	90	147
RFHH-2, TF,							
TFE, XF,							
XFF							
RFHH-2, TF,	16	11	20	32	56	72	119
TFE, XF,							
XFF							
XF, XFP	14	9	15	25	44	57	93
TFN, TFFN	18	23	39	63	111	144	236
	16	17	30	48	85	110	180
PF, PFF,	18	21	37	60	105	136	223
PGF, PGFF,	16	16	29	46	81	105	173
PAF, PTF,	14	12	21	35	61	79	129
PTFE, PAFF							
HF, HFF, ZF,	18	28	48	77	136	176	288
ZFF, ZHF	16	20	35	57	100	129	212
	14	15	26	42	73	95	156
KF-2, KFF-2	18	40	70	112	197	255	418
	16	28	49	79	139	180	295
	14	19	34	54	95	123	202
	12	13	23	37	65	85	139
	10	9	15	25	44	57	93
KF-1, KFF-1	18	48	83	134	235	304	499
	16	34	58	94	165	214	350
	14	23	39	63	111	144	236
	12	15	26	42	73	95	156
	10	10	17	27	48	62	102
XF, XFF	12	5	8	13	23	30	50
	10	3	6	10	18	23	39

Note: This table is for concentric stranded conductors only. For compact stranded conductors, Table C7(A) should be used.

(© 2001, NFPA)

TABLE 2.27 NEC Table C8: Maximum Number of Conductors or Fixture Wires in Rigid Metal Conduit (RMC)

		CONDUCTORS													
Type	Conductor Size (AWG/kcmil)	Metric Designator (Trade Size)													
		16 (½)	21 (¾)	27 (1)	35 (1¼)	41 (1½)	53 (2)	63 (2½)	78 (3)	91 (3½)	103 (4)	129 (5)	155 (6)		
RHH, RHW, RHW-2	14	4	7	12	21	28	46	66	102	136	176	276	398		
	12	3	6	10	17	23	38	55	85	113	146	229	330		
	10	3	5	8	14	19	31	44	68	91	118	185	267		
	8	1	2	4	7	10	16	23	36	48	61	97	139		
	6	1	1	3	6	8	13	18	29	38	49	77	112		
	4	1	1	2	4	6	10	14	22	30	38	60	87		
	3	1	1	2	4	5	9	12	19	26	34	53	76		
	2	1	1	1	3	4	7	11	17	23	29	46	66		
	1	0	1	1	1	3	5	7	11	15	19	30	44		
	1/0	0	1	1	1	2	4	6	10	13	17	26	38		
	2/0	0	1	1	1	2	4	5	8	11	14	23	33		
	3/0	0	0	1	1	1	3	4	7	10	12	20	28		
	4/0	0	0	1	1	1	3	4	6	8	11	17	24		
	250	0	0	0	1	1	1	3	4	6	8	13	18		
	300	0	0	0	1	1	1	2	4	5	7	11	16		
	350	0	0	0	1	1	1	2	4	5	6	10	15		
400	0	0	0	1	1	1	1	3	4	6	9	13			
500	0	0	0	1	1	1	1	3	4	5	8	11			
600	0	0	0	0	1	1	1	2	3	4	6	9			
700	0	0	0	0	1	1	1	1	3	4	6	8			
750	0	0	0	0	0	1	1	1	3	3	5	8			
800	0	0	0	0	0	1	1	1	2	3	5	7			
900	0	0	0	0	0	1	1	1	2	3	5	7			
1000	0	0	0	0	0	1	1	1	1	3	4	6			
1250	0	0	0	0	0	0	1	1	1	1	3	5			
1500	0	0	0	0	0	0	1	1	1	1	3	4			
1750	0	0	0	0	0	0	1	1	1	1	2	4			
2000	0	0	0	0	0	0	0	1	1	1	2	3			
TW, THW, THW, THW-2	14	9	15	25	44	59	98	140	216	288	370	581	839		
	12	7	12	19	33	45	75	107	165	221	284	446	644		
RHH*, RHW*, RHW-2*	14	6	10	17	29	39	65	93	143	191	246	387	558		
	12	5	8	13	23	32	52	75	115	154	198	311	448		
RHH*, RHW*, RHW-2*	10	3	6	10	18	25	41	58	90	120	154	242	350		
	8	1	4	6	11	15	24	35	54	72	92	145	209		
RHH*, RHW*, RHW-2*	6	1	3	5	8	11	18	27	41	55	71	111	160		
	4	1	1	3	6	8	14	20	31	41	53	83	120		
RHH*, RHW*, RHW-2*	3	1	1	3	5	7	12	17	26	35	45	71	103		
	2	1	1	2	4	6	10	14	22	30	38	60	87		
TW, THW, THW, THW-2	14	1	1	1	3	4	7	10	15	21	27	42	61		
	1/0	0	1	1	2	3	6	8	13	18	23	36	52		
RHH*, RHW*, RHW-2*	2/0	0	1	1	2	3	5	7	11	15	19	31	44		
	3/0	0	1	1	1	2	4	6	9	13	16	26	37		
RHH*, RHW*, RHW-2*	4/0	0	0	1	1	1	3	5	8	10	14	21	31		
	250	0	0	1	1	1	3	4	6	8	11	17	25		
RHH*, RHW*, RHW-2*	300	0	0	1	1	1	2	3	5	7	9	15	22		
	350	0	0	0	1	1	1	3	5	6	8	13	19		
RHH*, RHW*, RHW-2*	400	0	0	0	1	1	1	3	4	6	7	12	17		
	500	0	0	0	1	1	1	2	3	5	6	10	14		
RHH*, RHW*, RHW-2*	600	0	0	0	1	1	1	1	3	4	5	8	12		
	700	0	0	0	0	1	1	1	2	3	4	7	10		
RHH*, RHW*, RHW-2*	750	0	0	0	0	1	1	1	2	3	4	7	10		
	800	0	0	0	0	1	1	1	2	3	4	6	9		
RHH*, RHW*, RHW-2*	900	0	0	0	0	1	1	1	1	3	4	6	8		
	1000	0	0	0	0	0	1	1	1	2	3	5	8		
RHH*, RHW*, RHW-2*	1250	0	0	0	0	0	1	1	1	1	2	4	6		
	1500	0	0	0	0	0	1	1	1	1	2	3	5		
RHH*, RHW*, RHW-2*	1750	0	0	0	0	0	0	1	1	1	1	3	4		
	2000	0	0	0	0	0	0	1	1	1	1	3	4		

(continued)

TABLE 2.27 NEC Table C8: Maximum Number of Conductors or Fixture Wires in Rigid Metal Conduit (RMC) (*Continued*)

CONDUCTORS													
Type	Conductor Size (AWG/kcmil)	Metric Designator (Trade Size)											
		16 (½)	21 (¾)	27 (1)	35 (1¼)	41 (1½)	53 (2)	63 (2½)	78 (3)	91 (3½)	103 (4)	129 (5)	155 (6)
XHH, XHHW, XHHW-2	1	1	1	1	4	5	9	12	19	26	33	52	76
	1/0	1	1	1	3	4	7	10	16	22	28	44	64
	2/0	0	1	1	2	3	6	9	13	18	23	37	53
	3/0	0	1	1	1	3	5	7	11	15	19	30	44
	4/0	0	1	1	1	2	4	6	9	12	16	25	36
	250	0	0	1	1	1	3	5	7	10	13	20	30
	300	0	0	1	1	1	3	4	6	9	11	18	25
	350	0	0	1	1	1	2	3	6	7	10	15	22
	400	0	0	1	1	1	2	3	5	7	9	14	20
	500	0	0	0	1	1	1	2	4	5	7	11	16
	600	0	0	0	1	1	1	1	3	4	6	9	13
	700	0	0	0	1	1	1	1	3	4	5	8	11
	750	0	0	0	0	1	1	1	3	4	5	7	11
	800	0	0	0	0	1	1	1	2	3	4	7	10
	900	0	0	0	0	1	1	1	2	3	4	6	9
	1000	0	0	0	0	1	1	1	1	3	4	6	8
	1250	0	0	0	0	0	1	1	1	2	3	4	6
	1500	0	0	0	0	0	1	1	1	1	2	4	5
	1750	0	0	0	0	0	0	1	1	1	1	3	5
	2000	0	0	0	0	0	0	1	1	1	1	3	4

FIXTURE WIRES							
Type	Conductor Size (AWG/kcmil)	Metric Designator (Trade Size)					
		16 (½)	21 (¾)	27 (1)	35 (1¼)	41 (1½)	53 (2)
FFH-2, RFH-2, RFHH-3	18	8	15	24	42	57	94
SF-2, SFF-2	18	11	19	31	53	72	118
SF-1, SFF-1	16	9	15	25	44	59	98
	14	7	12	20	35	48	79
RFH-1, RFHH-2, TF, TFF, XF, XFF	18	19	33	54	94	127	209
RFH-1, RFHH-2, TF, TFF, XF, XFF	18	14	25	40	69	94	155
RFH-2, TF, TFF, XF, XFF	16	11	20	32	56	76	125
XF, XFF	14	9	15	25	44	59	98
TFN, TFFN	18	23	40	64	111	150	248
PF, PFF, PGF, PGFF, PAF, PTF, PTFE, PAFF	16	17	30	49	84	115	189
	18	21	38	61	105	143	235
HF, HFF, ZF, ZFF, ZHF	16	16	29	47	81	110	181
	14	12	22	35	61	83	136
KF-2, KFF-2	18	28	48	79	135	184	303
	16	20	36	58	100	136	223
KF-1, KFF-1	14	15	26	42	73	100	164
	18	40	71	114	197	267	439
	16	28	50	80	138	188	310
	14	19	34	55	95	129	213
XF, XFF	12	13	23	38	65	89	146
	10	9	15	25	44	59	98
	18	48	84	136	235	318	524
	16	34	59	96	165	224	368
XF, XFF	14	23	40	64	111	150	248
	12	15	26	42	73	100	164
	10	10	17	28	48	65	107
	12	5	8	13	23	32	52
	10	3	6	10	18	25	41

Note: This table is for concentric stranded conductors only. For compact stranded conductors, Table C8(A) should be used.

*Types RHH, RHW, and RHW-2 without outer covering.

(© 2001, NFPA)

TABLE 2.28 NEC Table C9: Maximum Number of Conductors or Fixture Wires in Rigid PVC Conduit, Schedule 80

		CONDUCTORS																										
		Metric Designator (Trade Size)																										
Type	Conductor Size (AWG/kcmil)	35																										
		16 (½)	21 (¾)	27 (1)	35 (1¼)	41 (1½)	53 (2)	63 (2½)	78 (3)	91 (3½)	103 (4)	129 (5)	155 (6)															
RHH,	14	3	5	9	17	23	39	56	88	118	153	243	349	RHW,	12	2	4	7	14	19	32	46	73	98	127	202	290	
RHW-2	10	1	3	6	11	15	26	37	59	79	103	163	234	8	1	1	3	6	8	13	19	31	41	54	85	122		
	8	1	1	3	6	8	13	19	31	41	54	85	122	6	1	1	2	4	6	11	16	24	33	43	68	98		
	4	1	1	1	3	5	8	12	19	26	33	53	77	3	0	1	1	3	4	7	11	17	23	29	47	67		
	3	0	1	1	3	4	7	11	17	23	29	47	67	2	0	1	1	3	4	6	9	14	20	25	41	58		
	2	0	1	1	3	4	6	9	14	20	25	41	58	1	0	1	1	2	4	6	9	13	17	27	38			
	1	0	1	1	2	4	6	9	13	17	27	38	1/0	0	0	1	1	1	3	5	8	11	15	23	33			
	2/0	0	0	1	1	1	3	4	7	10	13	20	29	3/0	0	0	1	1	1	3	4	6	8	11	17	25		
	3/0	0	0	1	1	1	3	4	6	8	11	17	25	4/0	0	0	0	1	1	2	3	5	7	9	15	21		
	4/0	0	0	0	1	1	2	3	5	7	9	15	21	250	0	0	0	1	1	1	2	4	5	7	11	16		
	250	0	0	0	1	1	1	2	3	5	6	10	14	300	0	0	0	1	1	1	1	3	4	5	9	13		
	300	0	0	0	1	1	1	1	3	4	5	9	13	350	0	0	0	1	1	1	1	3	4	5	9	13		
	350	0	0	0	1	1	1	1	3	4	5	9	13	400	0	0	0	0	1	1	1	3	4	5	8	12		
	400	0	0	0	0	1	1	1	3	4	5	8	12	500	0	0	0	0	1	1	1	2	3	4	7	10		
	500	0	0	0	0	1	1	1	2	3	4	7	10	600	0	0	0	0	0	1	1	1	3	3	6	8		
	600	0	0	0	0	0	1	1	1	3	3	6	8	700	0	0	0	0	0	1	1	1	2	3	5	7		
	700	0	0	0	0	0	1	1	1	2	3	5	7	750	0	0	0	0	0	1	1	1	2	3	5	7		
	750	0	0	0	0	0	1	1	1	2	3	5	7	800	0	0	0	0	0	1	1	1	2	3	4	7		
	800	0	0	0	0	0	1	1	1	2	3	4	7	1000	0	0	0	0	0	1	1	1	1	2	4	5		
	1000	0	0	0	0	0	1	1	1	1	2	4	5	1250	0	0	0	0	0	1	1	1	1	1	3	4		
	1250	0	0	0	0	0	1	1	1	1	1	3	4	1500	0	0	0	0	0	0	1	1	1	1	2	4		
	1500	0	0	0	0	0	0	1	1	1	1	2	4	1750	0	0	0	0	0	0	1	1	1	1	2	3		
	1750	0	0	0	0	0	0	1	1	1	1	2	3	2000	0	0	0	0	0	0	0	1	1	1	1	3		
	2000	0	0	0	0	0	0	0	1	1	1	1	3	TW,	14	6	11	20	35	49	82	118	185	250	324	514	736	
	TW,	12	5	9	15	27	38	63	91	142	192	248	394	565	THHW,	10	3	6	11	20	28	47	67	106	143	185	294	421
	THW,	8	1	3	6	11	15	26	37	59	79	103	163	234	THW-2	8	1	3	6	11	15	26	37	59	79	103	163	234
	RHH*,	14	4	8	13	23	32	55	79	123	166	215	341	490	RHW*,	12	3	6	10	19	26	44	63	99	133	173	274	394
	RHW*,	10	2	5	8	15	20	34	49	77	104	135	214	307	RHW-2*	8	1	3	5	9	12	20	29	46	62	81	128	184
	RHW-2*	8	1	3	5	9	12	20	29	46	62	81	128	184	RHH*,	6	1	1	3	7	9	16	22	35	48	62	98	141
	RHH*,	4	1	1	3	5	7	12	17	26	35	46	73	105	RHW*,	3	1	1	2	4	6	10	14	22	30	39	63	90
	RHW-2*,	2	1	1	1	3	5	8	12	19	26	33	53	77	TW,	1	0	1	1	2	3	6	8	13	18	23	37	54
	TW,	1	0	1	1	2	3	6	8	13	18	23	37	54	THHW,	1/0	0	1	1	1	3	5	7	11	15	20	32	46
	THHW,	2/0	0	1	1	1	2	4	6	10	13	17	27	39	3/0	0	0	1	1	1	3	5	8	11	14	23	33	
	THW-2	3/0	0	0	1	1	1	3	5	8	11	14	23	33	4/0	0	0	1	1	1	3	4	7	9	12	19	27	
	THW-2	4/0	0	0	1	1	1	3	4	7	9	12	19	27	250	0	0	0	1	1	2	3	5	7	9	15	22	
	250	0	0	0	1	1	1	2	3	5	6	8	13	19	300	0	0	0	1	1	1	3	5	6	8	13	19	
	300	0	0	0	1	1	1	1	2	4	6	7	12	17	350	0	0	0	1	1	1	2	4	6	7	12	17	
	350	0	0	0	1	1	1	1	2	4	6	7	12	17	400	0	0	0	1	1	1	2	4	5	7	10	15	
	400	0	0	0	1	1	1	1	2	4	5	7	10	15	500	0	0	0	1	1	1	1	3	4	5	9	13	
	500	0	0	0	1	1	1	1	3	4	5	9	13	600	0	0	0	0	1	1	1	2	3	4	7	10		
	600	0	0	0	0	1	1	1	2	3	4	7	10	700	0	0	0	0	1	1	1	2	3	4	6	9		
	700	0	0	0	0	1	1	1	2	3	4	6	9	750	0	0	0	0	0	1	1	1	3	4	6	8		
	750	0	0	0	0	0	1	1	1	3	3	6	8	800	0	0	0	0	0	1	1	1	3	3	6	8		
	800	0	0	0	0	0	1	1	1	3	3	6	8	900	0	0	0	0	0	1	1	1	2	3	5	7		
	900	0	0	0	0	0	1	1	1	2	3	5	7	1000	0	0	0	0	0	1	1	1	2	3	5	7		
	1000	0	0	0	0	0	1	1	1	2	3	5	7	1250	0	0	0	0	0	1	1	1	1	2	4	5		
	1250	0	0	0	0	0	1	1	1	1	2	4	5	1500	0	0	0	0	0	0	1	1	1	1	3	4		
	1500	0	0	0	0	0	0	1	1	1	1	3	4	1750	0	0	0	0	0	0	1	1	1	1	3	4		
	1750	0	0	0	0	0	0	1	1	1	1	3	4	2000	0	0	0	0	0	0	0	1	1	1	2	3		
	2000	0	0	0	0	0	0	0	1	1	1	2	3															

(continued)

TABLE 2.28 NEC Table C9: Maximum Number of Conductors or Fixture Wires in Rigid PVC Conduit, Schedule 80 (Continued)

		CONDUCTORS													
		Metric Designator (Trade Size)													
Type	Conductor Size (AWG/kcmil)	35												(5)	(6)
		16 (½)	21 (¾)	27 (1)	(1¼)	41 (1½)	53 (2)	63 (2½)	78 (3)	91 (3½)	103 (4)	129 (5)	155 (6)		
THHN, THWN, THWN-2	14	9	17	28	51	70	118	170	265	358	464	736	1055		
	12	6	12	20	37	51	86	124	193	261	338	537	770		
	10	4	7	13	23	32	54	78	122	164	213	338	485		
	8	2	4	7	13	18	31	45	70	95	123	195	279		
	6	1	3	5	9	13	22	32	51	68	89	141	202		
	4	1	1	3	6	8	14	20	31	42	54	86	124		
	3	1	1	3	5	7	12	17	26	35	46	73	105		
	2	1	1	2	4	6	10	14	22	30	39	61	88		
	1	0	1	1	3	4	7	10	16	22	29	45	65		
	1/0	0	1	1	2	3	6	9	14	18	24	38	55		
	2/0	0	1	1	1	3	5	7	11	15	20	32	46		
	3/0	0	1	1	1	2	4	6	9	13	17	26	38		
	4/0	0	0	1	1	1	3	5	8	10	14	22	31		
	250	0	0	1	1	1	3	4	6	8	11	18	25		
	300	0	0	0	1	1	2	3	5	7	9	15	22		
	350	0	0	0	1	1	1	3	5	6	8	13	19		
	400	0	0	0	1	1	1	3	4	6	7	12	17		
	500	0	0	0	1	1	1	2	3	5	6	10	14		
	600	0	0	0	0	1	1	1	3	4	5	8	12		
700	0	0	0	0	1	1	1	2	3	4	7	10			
750	0	0	0	0	1	1	1	2	3	4	7	9			
800	0	0	0	0	1	1	1	2	3	4	6	9			
900	0	0	0	0	0	1	1	1	3	3	6	8			
1000	0	0	0	0	0	1	1	1	2	3	5	7			
FEP, FEPB, PFA, PFAH, TFE	14	8	16	27	49	68	115	164	257	347	450	714	1024		
	12	6	12	20	36	50	84	120	188	253	328	521	747		
	10	4	8	14	26	36	60	86	135	182	235	374	536		
	8	2	5	8	15	20	34	49	77	104	135	214	307		
	6	1	3	6	10	14	24	35	55	74	96	152	218		
	4	1	2	4	7	10	17	24	38	52	67	106	153		
PFA, PFAH, TFE	3	1	1	3	6	8	14	20	32	43	56	89	127		
	2	1	1	3	5	7	12	17	26	35	46	73	105		
	1	1	1	1	3	5	8	11	18	25	32	51	73		
PFA, PFAH, TFE, Z	1/0	0	1	1	3	4	7	10	15	20	27	42	61		
	2/0	0	1	1	2	3	5	8	12	17	22	35	50		
	3/0	0	1	1	1	2	4	6	10	14	18	29	41		
	4/0	0	0	1	1	1	4	5	8	11	15	24	34		
	Z	14	10	19	33	59	82	138	198	310	418	542	860	1233	
XHH, XHHW, XHHW-2, ZW	12	7	14	23	42	58	98	141	220	297	385	610	875		
	10	4	8	14	26	36	60	86	135	182	235	374	536		
	8	3	5	9	16	22	38	54	85	115	149	236	339		
	6	2	4	6	11	16	26	38	60	81	104	166	238		
	4	1	2	4	8	11	18	26	41	55	72	114	164		
	3	1	2	3	5	8	13	19	30	40	52	83	119		
	2	1	1	2	5	6	11	16	25	33	43	69	99		
	1	0	1	2	4	5	9	13	20	27	35	56	80		
	14	6	11	20	35	49	82	118	185	250	324	514	736		
	12	5	9	15	27	38	63	91	142	192	248	394	565		
	10	3	6	11	20	28	47	67	106	143	185	294	421		
	8	1	3	6	11	15	26	37	59	79	103	163	234		
	6	1	2	4	8	11	19	28	43	59	76	121	173		
	4	1	1	3	6	8	14	20	31	42	55	87	125		
	3	1	1	3	5	7	12	17	26	36	47	74	106		
2	1	1	2	4	6	10	14	22	30	39	62	89			

(continued)

TABLE 2.28 NEC Table C9: Maximum Number of Conductors or Fixture Wires in Rigid PVC Conduit, Schedule 80 (Continued)

		CONDUCTORS											
		Metric Designator (Trade Size)											
Type	Conductor Size (AWG/kcmil)	35										155 (6)	
		16 (½)	21 (¾)	27 (1)	41 (1¼)	53 (1½)	63 (2)	78 (2½)	91 (3)	103 (3½)	129 (4)		
XHH,	1	0	1	1	3	4	7	10	16	22	29	46	66
XHHW,	1/0	0	1	1	2	3	6	9	14	19	24	39	56
XHHW-2	2/0	0	1	1	1	3	5	7	11	16	20	32	46
	3/0	0	1	1	1	2	4	6	9	13	17	27	38
	4/0	0	0	1	1	1	3	5	8	11	14	22	32
	250	0	0	1	1	1	3	4	6	9	11	18	26
	300	0	0	1	1	1	2	3	5	7	10	15	22
	350	0	0	0	1	1	1	3	5	6	8	14	20
	400	0	0	0	1	1	1	3	4	6	7	12	17
	500	0	0	0	1	1	1	2	3	5	6	10	14
	600	0	0	0	0	1	1	1	3	4	5	8	11
	700	0	0	0	0	1	1	1	2	3	4	7	10
	750	0	0	0	0	1	1	1	2	3	4	6	9
	800	0	0	0	0	1	1	1	1	3	4	6	9
	900	0	0	0	0	0	1	1	—	3	3	5	8
	1000	0	0	0	0	0	1	1	1	2	3	5	7
	1250	0	0	0	0	0	1	1	1	1	2	4	6
	1500	0	0	0	0	0	0	1	1	1	1	3	5
	1750	0	0	0	0	0	0	1	1	1	1	3	4
	2000	0	0	0	0	0	0	1	1	1	1	2	4

		FIXTURE WIRES					
		Metric Designator (Trade Size)					
Type	Conductor Size (AWG/kcmil)	35					53 (2)
		16 (½)	21 (¾)	27 (1)	41 (1¼)	41 (1½)	
FFH-2,	18	6	11	19	34	47	79
RFH-2,	16	5	9	16	28	39	67
RFHH-3							
SF-2, SFF-2	18	7	14	24	43	59	100
	16	6	11	20	35	49	82
	14	5	9	16	28	39	67
SF-1, SFF-1	18	13	25	42	76	105	177
RFH-1,	18	10	18	31	56	77	130
RFHH-2, TF,							
TF, XF,							
XFF							
RFHH-2, TF,	16	8	15	25	45	62	105
TF, XF,							
XFF							
XF, XFF	14	6	11	20	35	49	82
TFN, TFFN	18	16	29	50	90	124	209
	16	12	22	38	68	95	159
PF, PFF,	18	15	28	47	85	118	198
PGF, PGFF,	16	11	22	36	66	91	153
PAF, PTF,	14	8	16	27	49	68	115
PTFF, PAFF							
HF, HFF, ZF,	18	19	36	61	110	152	255
ZFF, ZHF	16	14	27	45	81	112	188
	14	10	19	33	59	82	138
KF-2, KFF-2	18	28	53	88	159	220	371
	16	19	37	62	112	155	261
	14	13	25	43	77	107	179
	12	9	17	29	53	73	123
	10	6	11	20	35	49	82
KF-1, KFF-1	18	33	63	106	190	263	442
	16	23	44	74	133	185	310
	14	16	29	50	90	124	209
	12	10	19	33	59	82	138
	10	7	13	21	39	54	90
XF, XFF	12	3	6	10	19	26	44
	10	2	5	8	15	20	34

Note: This table is for concentric stranded conductors only. For compact stranded conductors, Table C9(A) should be used.

*Types RHH, RHW, and RHW-2 without outer covering.

(© 2001, NFPA)

TABLE 2.29 NEC Table C10: Maximum Number of Conductors or Fixture Wires in Rigid PVC Conduit, Schedule 40 and HDPE Conduit

CONDUCTORS													
Type	Conductor Size (AWG/kcmil)	Metric Designator (Trade Size)											
		16 (½)	21 (¾)	27 (1)	35 (1¼)	41 (1½)	53 (2)	63 (2½)	78 (3)	91 (3½)	103 (4)	129 (5)	155 (6)
RHH, RHW, RHW-2	14	4	7	11	20	27	45	64	99	133	171	269	390
	12	3	5	9	16	22	37	53	82	110	142	224	323
	10	2	4	7	13	18	30	43	66	89	115	181	261
	8	1	2	4	7	9	15	22	35	46	60	94	137
	6	1	1	3	5	7	12	18	28	37	48	76	109
	4	1	1	2	4	6	10	14	22	29	37	59	85
	3	1	1	1	4	5	8	12	19	25	33	52	75
	2	1	1	1	3	4	7	10	16	22	28	45	65
	1	0	1	1	1	3	5	7	11	14	19	29	43
	1/0	0	1	1	1	2	4	6	9	13	16	26	37
	2/0	0	0	1	1	1	3	5	8	11	14	22	32
	3/0	0	0	1	1	1	3	4	7	9	12	19	28
	4/0	0	0	1	1	1	2	4	6	8	10	16	24
	250	0	0	0	1	1	1	3	4	6	8	12	18
	300	0	0	0	1	1	1	2	4	5	7	11	16
	350	0	0	0	1	1	1	2	3	5	6	10	14
	400	0	0	0	1	1	1	1	3	4	6	9	13
	500	0	0	0	0	1	1	1	3	4	5	8	11
	600	0	0	0	0	1	1	1	2	3	4	6	9
	700	0	0	0	0	0	1	1	1	3	3	6	8
750	0	0	0	0	0	1	1	1	2	3	5	8	
800	0	0	0	0	0	1	1	1	2	3	5	7	
900	0	0	0	0	0	1	1	1	2	3	5	7	
1000	0	0	0	0	0	1	1	1	1	3	4	6	
1250	0	0	0	0	0	0	1	1	1	1	3	5	
1500	0	0	0	0	0	0	1	1	1	1	3	4	
1750	0	0	0	0	0	0	1	1	1	1	2	3	
2000	0	0	0	0	0	0	0	1	1	1	2	3	
TW, THHW, THW, THW-2	14	8	14	24	42	57	94	135	209	280	361	568	822
	12	6	11	18	32	44	72	103	160	215	277	436	631
	10	4	8	13	24	32	54	77	119	160	206	325	470
	8	2	4	7	13	18	30	43	66	89	115	181	261
RHH*, RHW*, RHW-2*	14	5	9	16	28	38	63	90	139	186	240	378	546
	12	4	8	12	22	30	50	72	112	150	193	304	439
	10	3	6	10	17	24	39	56	87	117	150	237	343
	8	1	3	6	10	14	23	33	52	70	90	142	205
TW, THW, THHW, THW-2	6	1	2	4	8	11	18	26	40	53	69	109	157
	4	1	1	3	6	8	13	19	30	40	51	81	117
	3	1	1	3	5	7	11	16	25	34	44	69	100
	2	1	1	2	4	6	10	14	22	29	37	59	85
	1	0	1	1	3	4	7	10	15	20	26	41	60
	1/0	0	1	1	2	3	6	8	13	17	22	35	51
	2/0	0	1	1	1	3	5	7	11	15	19	30	43
	3/0	0	1	1	1	2	4	6	9	12	16	25	36
	4/0	0	0	1	1	1	3	5	8	10	13	21	30
	250	0	0	1	1	1	3	4	6	8	11	17	25
	300	0	0	1	1	1	2	3	5	7	9	15	21
	350	0	0	0	1	1	1	3	5	6	8	13	19
	400	0	0	0	1	1	1	3	4	6	7	12	17
	500	0	0	0	1	1	1	2	3	5	6	10	14
	600	0	0	0	0	1	1	1	3	4	5	8	11
	700	0	0	0	0	1	1	1	2	3	4	7	10
	750	0	0	0	0	1	1	1	2	3	4	6	10
	800	0	0	0	0	1	1	1	2	3	4	6	9
	900	0	0	0	0	0	1	1	1	3	3	6	8
	1000	0	0	0	0	0	1	1	1	2	3	5	7
1250	0	0	0	0	0	1	1	1	1	2	4	6	
1500	0	0	0	0	0	1	1	1	1	1	3	5	
1750	0	0	0	0	0	0	1	1	1	1	3	4	
2000	0	0	0	0	0	0	1	1	1	1	3	4	

(continued)

TABLE 2.29 NEC Table C10: Maximum Number of Conductors or Fixture Wires in Rigid PVC Conduit, Schedule 40 and HDPE Conduit
(Continued)

		CONDUCTORS																		
Type	Conductor Size (AWG/kcmil)	Metric Designator (Trade Size)																		
		16 (½)	21 (¾)	27 (1)	35 (1¼)	41 (1½)	53 (2)	63 (2½)	78 (3)	91 (3½)	103 (4)	129 (5)	155 (6)							
THHN, THWN, THWN-2	14	11	21	34	60	82	135	193	299	401	517	815	1178							
	12	8	15	25	43	59	99	141	218	293	377	594	859							
	10	5	9	15	27	37	62	89	137	184	238	374	541							
	8	3	5	9	16	21	36	51	79	106	137	216	312							
	6	1	4	6	11	15	26	37	57	77	99	156	225							
	4	1	2	4	7	9	16	22	35	47	61	96	138							
	3	1	1	3	6	8	13	19	30	40	51	81	117							
	2	1	1	3	5	7	11	16	25	33	43	68	98							
	1	1	1	1	3	5	8	12	18	25	32	50	73							
	1/0	1	1	1	3	4	7	10	15	21	27	42	61							
	2/0	0	1	1	2	3	6	8	13	17	22	35	51							
	3/0	0	1	1	1	3	5	7	11	14	18	29	42							
	4/0	0	1	1	1	2	4	6	9	12	15	24	35							
	250	0	0	1	1	1	3	4	7	10	12	20	28							
	300	0	0	1	1	1	3	4	6	8	11	17	24							
	350	0	0	1	1	1	2	3	5	7	9	15	21							
	400	0	0	0	1	1	1	3	5	6	8	13	19							
	500	0	0	0	1	1	1	2	4	5	7	11	16							
	600	0	0	0	1	1	1	1	3	4	5	9	13							
	700	0	0	0	0	1	1	1	3	4	5	8	11							
750	0	0	0	0	1	1	1	2	3	4	7	11								
800	0	0	0	0	1	1	1	2	3	4	7	10								
900	0	0	0	0	1	1	1	2	3	4	6	9								
1000	0	0	0	0	0	1	1	1	3	3	6	8								
FEP, FEPB, PFA, PFAH, TFE	14	11	20	33	58	79	131	188	290	389	502	790	1142							
	12	8	15	24	42	58	96	137	212	284	366	577	834							
	10	6	10	17	30	41	69	98	152	204	263	414	598							
	8	3	6	10	17	24	39	56	87	117	150	237	343							
	6	2	4	7	12	17	28	40	62	83	107	169	244							
	4	1	3	5	8	12	19	28	43	58	75	118	170							
PFA, PFAH, TFE	3	1	2	4	7	10	16	23	36	48	62	98	142							
	2	1	1	3	6	8	13	19	30	40	51	81	117							
	1	1	1	2	4	5	9	13	20	28	36	56	81							
	1/0	1	1	1	3	4	8	11	17	23	30	47	68							
	2/0	0	1	1	3	4	6	9	14	19	24	39	56							
	3/0	0	1	1	2	3	5	7	12	16	20	32	46							
Z	4/0	0	1	1	1	2	4	6	9	13	16	26	38							
	14	13	24	40	70	95	158	226	350	469	605	952	1376							
	12	9	17	28	49	68	112	160	248	333	429	675	976							
	10	6	10	17	30	41	69	98	152	204	263	414	598							
	8	3	6	11	19	26	43	62	96	129	166	261	378							
	6	2	4	7	13	18	30	43	67	90	116	184	265							
XHH, XHHW, XHHW-2, ZW	4	1	3	5	9	12	21	30	46	62	80	126	183							
	3	1	2	4	6	9	15	22	34	45	58	92	133							
	2	1	1	3	5	7	12	18	28	38	49	77	111							
	1	1	1	2	4	6	10	14	23	30	39	62	90							
	14	8	14	24	42	57	94	135	209	280	361	568	822							
	12	6	11	18	32	44	72	103	160	215	277	436	631							
XHH, XHHW, XHHW-2	10	4	8	13	24	32	54	77	119	160	206	325	470							
	8	2	4	7	13	18	30	43	66	89	115	181	261							
	6	1	3	5	10	13	22	32	49	66	85	134	193							
	4	1	2	4	7	9	16	23	35	48	61	97	140							
	3	1	1	3	6	8	13	19	30	40	52	82	118							
	2	1	1	3	5	7	11	16	25	34	44	69	99							
XHH, XHHW, XHHW-2	1	1	1	3	5	8	12	19	25	32	51	74								
	1/0	1	1	1	3	4	7	10	16	21	27	43	62							
	2/0	0	1	1	2	3	6	8	13	17	23	36	52							
	3/0	0	1	1	1	3	5	7	11	14	19	30	43							
	4/0	0	1	1	1	2	4	6	9	12	15	24	35							
	250	0	0	1	1	1	3	5	7	10	13	20	29							
XHH, XHHW, XHHW-2	300	0	0	1	1	1	3	4	6	8	11	17	25							
	350	0	0	1	1	1	2	3	5	7	9	15	22							
	400	0	0	0	1	1	1	3	5	6	8	13	19							
	500	0	0	0	1	1	1	2	4	5	7	11	16							
	600	0	0	0	1	1	1	1	3	4	5	9	13							
	700	0	0	0	0	1	1	1	3	4	5	8	11							
XHH, XHHW, XHHW-2	750	0	0	0	0	1	1	1	2	3	4	7	11							
	800	0	0	0	0	1	1	1	2	3	4	7	10							
	900	0	0	0	0	1	1	1	2	3	4	6	9							
	1000	0	0	0	0	0	1	1	1	3	3	6	8							
	1250	0	0	0	0	0	1	1	1	1	3	4	6							
	1500	0	0	0	0	0	1	1	1	1	2	4	5							
XHH, XHHW, XHHW-2	1750	0	0	0	0	0	0	1	1	1	3	5								
	2000	0	0	0	0	0	0	1	1	1	3	4								

(continued)

TABLE 2.29 NEC Table C10: Maximum Number of Conductors or Fixture Wires in Rigid PVC Conduit, Schedule 40 and HDPE Conduit (*Continued*)

FIXTURE WIRES							
Type	Conductor Size (AWG/kcmil)	Metric Designator (Trade Size)					
		16 (½)	21 (¾)	27 (1)	35 (1¼)	41 (1½)	53 (2)
FFH-2, RFH-2, RFHH-3	18	8	14	23	40	54	90
	16	6	12	19	33	46	76
SF-2, SFF-2	18	10	17	29	50	69	114
	16	8	14	24	42	57	94
	14	6	12	19	33	46	76
SF-1, SFF-1	18	17	31	51	89	122	202
RFHH-2, TF, TF, XF, XFF RFH-1, RFHH-2, TF, TF, XF, XFF	18	13	23	38	66	90	149
	16	10	18	30	53	73	120
XF, XFF	14	8	14	24	42	57	94
TFN, TFFN	18	20	37	60	105	144	239
	16	16	28	46	80	110	183
PF, PFF, PGF, PGFF, PAF, PTF, PTFF, PAFF	18	19	35	57	100	137	227
	16	15	27	44	77	106	175
	14	11	20	33	58	79	131
HF, HFF, ZF, ZFF, ZHF	18	25	45	74	129	176	292
	16	18	33	54	95	130	216
	14	13	24	40	70	95	158
KF-2, KFF-2	18	36	65	107	187	256	424
	16	26	46	75	132	180	299
	14	17	31	52	90	124	205
	12	12	22	35	62	85	141
	10	8	14	24	42	57	94
KF-1, KFF-1	18	43	78	128	223	305	506
	16	30	55	90	157	214	355
	14	20	37	60	105	144	239
	12	13	24	40	70	95	158
	10	9	16	26	45	62	103
XF, XFF	12	4	8	12	22	30	50
	10	3	6	10	17	24	39

Note: This table is for concentric stranded conductors only. For compact stranded conductors, Table C10(A) should be used.

*Types RHH, RHW, and RHW-2 without outer covering.

(© 2001, NFPA)

TABLE 2.30 NEC Table C11: Maximum Number of Conductors or Fixture Wires in Type A Rigid PVC Conduit

		CONDUCTORS									
		Metric Designator (Trade Size)									
Type	Conductor Size (AWG/kcmil)	16	21	27	35	41	53	63	78	91	103
		($\frac{1}{2}$)	($\frac{3}{4}$)	(1)	(1 $\frac{1}{4}$)	(1 $\frac{1}{2}$)	(2)	(2 $\frac{1}{2}$)	(3)	(3 $\frac{1}{2}$)	(4)
RHH, RHW RHW-2	14	5	9	15	24	31	49	74	112	146	187
	12	4	7	12	20	26	41	61	93	121	155
	10	3	6	10	16	21	33	50	75	98	125
	8	1	3	5	8	11	17	26	39	51	65
	6	1	2	4	6	9	14	21	31	41	52
	4	1	1	3	5	7	11	16	24	32	41
	3	1	1	3	4	6	9	14	21	28	36
	2	1	1	2	4	5	8	12	18	24	31
	1	0	1	1	2	3	5	8	12	16	20
	1/0	0	1	1	2	3	5	7	10	14	18
	2/0	0	1	1	1	2	4	6	9	12	15
	3/0	0	1	1	1	1	3	5	8	10	13
	4/0	0	0	1	1	1	3	4	7	9	11
	250	0	0	1	1	1	1	3	5	7	8
	300	0	0	1	1	1	1	3	4	6	7
	350	0	0	0	1	1	1	2	4	5	7
	400	0	0	0	1	1	1	2	4	5	6
	500	0	0	0	1	1	1	1	3	4	5
	600	0	0	0	0	1	1	1	2	3	4
	700	0	0	0	0	1	1	1	2	3	4
750	0	0	0	0	1	1	1	1	3	4	
800	0	0	0	0	1	1	1	1	3	3	
900	0	0	0	0	0	1	1	1	2	3	
1000	0	0	0	0	0	1	1	1	2	3	
1250	0	0	0	0	0	1	1	1	1	2	
1500	0	0	0	0	0	0	1	1	1	1	
1750	0	0	0	0	0	0	1	1	1	1	
2000	0	0	0	0	0	0	1	1	1	1	
TW,	14	11	18	31	51	67	105	157	235	307	395
THHW,	12	8	14	24	39	51	80	120	181	236	303
THW,	10	6	10	18	29	38	60	89	135	176	226
THW-2	8	3	6	10	16	21	33	50	75	98	125

(continued)

TABLE 2.30 NEC Table C11: Maximum Number of Conductors or Fixture Wires in Type A Rigid PVC Conduit (Continued)

CONDUCTORS											
Type	Conductor Size (AWG/kcmil)	Metric Designator (Trade Size)									
		16 (½)	21 (¾)	27 (1)	35 (1¼)	41 (1½)	53 (2)	63 (2½)	78 (3)	91 (3½)	103 (4)
RHH*	14	7	12	20	34	44	70	104	157	204	262
RHW*	12	6	10	16	27	35	56	84	126	164	211
RHW-2*	10	4	8	13	21	28	44	65	98	128	165
	8	2	4	8	12	16	26	39	59	77	98
RHH,	6	1	3	6	9	13	20	30	45	59	75
RHW*											
TW, THW,	4	1	2	4	7	9	15	22	33	44	56
THHW,	3	1	1	4	6	8	13	19	29	37	48
THW-2	2	1	1	3	5	7	11	16	24	32	41
	1	1	1	1	3	5	7	11	17	22	29
	1/0	1	1	1	3	4	6	10	14	19	24
	2/0	0	1	1	2	3	5	8	12	16	21
	3/0	0	1	1	1	3	4	7	10	13	17
	4/0	0	1	1	1	2	4	6	9	11	14
	250	0	0	1	1	1	3	4	7	9	12
	300	0	0	1	1	1	2	4	6	8	10
	350	0	0	1	1	1	2	3	5	7	9
	400	0	0	1	1	1	1	3	5	6	8
	500	0	0	0	1	1	1	2	4	5	7
	600	0	0	0	1	1	1	1	3	4	5
	700	0	0	0	1	1	1	1	3	4	5
	750	0	0	0	1	1	1	1	3	3	4
	800	0	0	0	0	1	1	1	2	3	4
	900	0	0	0	0	1	1	1	2	3	4
	1000	0	0	0	0	1	1	1	1	3	3
	1250	0	0	0	0	0	1	1	1	1	3
	1500	0	0	0	0	0	1	1	1	1	2
	1750	0	0	0	0	0	0	1	1	1	1
	2000	0	0	0	0	0	0	1	1	1	1
THHN,	14	16	27	44	73	96	150	225	338	441	566
THWN,	12	11	19	32	53	70	109	164	246	321	412
THWN-2	10	7	12	20	33	44	69	103	155	202	260
	8	4	7	12	19	25	40	59	89	117	150
	6	3	5	8	14	18	28	43	64	84	108
	4	1	3	5	8	11	17	26	39	52	66
	3	1	2	4	7	9	15	22	33	44	56
	2	1	1	3	6	8	12	19	28	37	47
	1	1	1	2	4	6	9	14	21	27	35
	1/0	1	1	2	4	5	8	11	17	23	29
	2/0	1	1	1	3	4	6	10	14	19	24
	3/0	0	1	1	2	3	5	8	12	16	20
	4/0	0	1	1	1	3	4	6	10	13	17
	250	0	1	1	1	2	3	5	8	10	14
	300	0	0	1	1	1	3	4	7	9	12
	350	0	0	1	1	1	2	4	6	8	10
	400	0	0	1	1	1	2	3	5	7	9
	500	0	0	1	1	1	1	3	4	6	7
	600	0	0	0	1	1	1	2	3	5	6
	700	0	0	0	1	1	1	1	3	4	5
	750	0	0	0	1	1	1	1	3	4	5
	800	0	0	0	1	1	1	1	3	4	5
	900	0	0	0	0	1	1	1	2	3	4
	1000	0	0	0	0	1	1	1	2	3	4
FEP,	14	15	26	43	70	93	146	218	327	427	549
FEPB,	12	11	19	31	51	68	106	159	239	312	400
PFA,	10	8	13	22	37	48	76	114	171	224	287
PFAH,	8	4	8	13	21	28	44	65	98	128	165
TFE	6	3	5	9	15	20	31	46	70	91	117
	4	1	4	6	10	14	21	32	49	64	82
	3	1	3	5	8	11	18	27	40	53	68
	2	1	2	4	7	9	15	22	33	44	56
PFA,	1	1	1	3	5	6	10	15	23	30	39
PFAH,											
TFE											
PFA,	1/0	1	1	2	4	5	8	13	19	25	32
PFAH,	2/0	1	1	1	3	4	7	10	16	21	27
TFE, Z	3/0	1	1	1	3	3	6	9	13	17	22
	4/0	0	1	1	2	3	5	7	11	14	18
Z	14	18	31	52	85	112	175	263	395	515	661
	12	13	22	37	60	79	124	186	280	365	469
	10	8	13	22	37	48	76	114	171	224	287
	8	5	8	14	23	30	48	72	108	141	181
	6	3	6	10	16	21	34	50	75	99	127
	4	2	4	7	11	15	23	35	52	68	88
	3	1	3	5	8	11	17	25	38	50	64
	2	1	2	4	7	9	14	21	32	41	53
	1	1	1	3	5	7	11	17	26	33	43
XHH,	14	11	18	31	51	67	105	157	235	307	395
XHHW,	12	8	14	24	39	51	80	120	181	236	303
XHHW-2,	10	6	10	18	29	38	60	89	135	176	226
ZW	8	3	6	10	16	21	33	50	75	98	125
	6	2	4	7	12	15	24	37	55	72	93
	4	1	3	5	8	11	18	26	40	52	67
	3	1	2	4	7	9	15	22	34	44	57
	2	1	1	3	6	8	12	19	28	37	48

(continued)

TABLE 2.30 NEC Table C11: Maximum Number of Conductors or Fixture Wires in Type A Rigid PVC Conduit (*Continued*)

CONDUCTORS											
Type	Conductor Size (AWG/kcmil)	Metric Designator (Trade Size)									
		16 (½)	21 (¾)	27 (1)	35 (1¼)	41 (1½)	53 (2)	63 (2½)	78 (3)	91 (3½)	103 (4)
XHH, XHHW, XHHW-2	1	1	1	3	4	6	9	14	21	28	35
	1/0	1	1	2	4	5	8	12	18	23	30
	2/0	1	1	1	3	4	6	10	15	19	25
	3/0	0	1	1	2	3	5	8	12	16	20
	4/0	0	1	1	1	3	4	7	10	13	17
	250	0	1	1	1	2	3	5	8	11	14
	300	0	0	1	1	1	3	5	7	9	12
	350	0	0	1	1	1	3	4	6	8	10
	400	0	0	1	1	1	2	3	5	7	9
	500	0	0	1	1	1	1	3	4	6	8
	600	0	0	0	1	1	1	2	3	5	6
	700	0	0	0	1	1	1	1	3	4	5
	750	0	0	0	1	1	1	1	3	4	5
	800	0	0	0	1	1	1	1	3	4	5
	900	0	0	0	0	1	1	1	2	3	4
	1000	0	0	0	0	1	1	1	2	3	4
	1250	0	0	0	0	0	1	1	1	2	3
	1500	0	0	0	0	0	1	1	1	1	2
	1750	0	0	0	0	0	1	1	1	1	2
	2000	0	0	0	0	0	0	1	1	1	1

FIXTURE WIRES							
Type	Conductor Size (AWG/kcmil)	Metric Designator (Trade Size)					
		16 (½)	21 (¾)	27 (1)	35 (1¼)	41 (1½)	53 (2)
FFH-2, RFH-2, RFHH-3	18	10	18	30	48	64	100
SF-2, SFF-2	18	13	22	37	61	81	127
	16	11	18	31	51	67	105
	14	9	15	25	41	54	85
SF-1, SFF-1	18	23	40	66	108	143	224
RFH-1, RFHH-2, TF, TFF, XF, XFF	18	17	29	49	80	105	165
RFHH-2, TF, TFF, XF, XFF	16	14	24	39	65	85	134
XF, XFF	14	11	18	31	51	67	105
TFN, TFFN	18	28	47	79	128	169	265
	16	21	36	60	98	129	202
PF, PFF, PGF, PGFF, PAF, PTF, PTFE, PAFF	18	26	45	74	122	160	251
	16	20	34	58	94	124	194
	14	15	26	43	70	93	146
HF, HFF, ZF, ZFF, ZHF	18	34	58	96	157	206	324
	16	25	42	71	116	152	239
	14	18	31	52	85	112	175
KF-2, KFF-2	18	49	84	140	228	300	470
	16	35	59	98	160	211	331
	14	24	40	67	110	145	228
	12	16	28	46	76	100	157
	10	11	18	31	51	67	105
KF-1, KFF-1	18	59	100	167	272	357	561
	16	41	70	117	191	251	394
	14	28	47	79	128	169	265
	12	18	31	52	85	112	175
	10	12	20	34	55	73	115
XF, XFF	12	6	10	16	27	35	56
	10	4	8	13	21	28	44

Note: This table is for concentric stranded conductors only. For compact stranded conductors, Table C11(A) should be used.

*Types RHH, RHW, and RWH-2 without outer covering.

(© 2001, NFPA)

TABLE 2.31 NEC Table C12: Maximum Number of Conductors in Type EB PVC Conduit

CONDUCTORS							
Type	Conductor Size (AWG/kcmil)	Metric Designator (Trade Size)					
		53 (2)	78 (3)	91 (3¼)	103 (4)	129 (5)	155 (6)
RHH, RHW, RHW-2	14	53	119	155	197	303	430
	12	44	98	128	163	251	357
RHH, RHW, RHW-2	10	35	79	104	132	203	288
	8	18	41	54	69	106	151
	6	15	33	43	55	85	121
	4	11	26	34	43	66	94
	3	10	23	30	38	58	83
	2	9	20	26	33	50	72
	1	6	13	17	21	33	47
	1/0	5	11	15	19	29	41
	2/0	4	10	13	16	25	36
	3/0	4	8	11	14	22	31
	4/0	3	7	9	12	18	26
	250	2	5	7	9	14	20
	300	1	5	6	8	12	17
	350	1	4	5	7	11	16
	400	1	4	5	6	10	14
	500	1	3	4	5	9	12
	600	1	3	3	4	7	10
	700	1	2	3	4	6	9
	750	1	2	3	4	6	9
	800	1	2	3	4	6	8
	900	1	1	2	3	5	7
	1000	1	1	2	3	5	7
	1250	1	1	1	2	3	5
	1500	0	1	1	1	3	4
	1750	0	1	1	1	3	4
	2000	0	1	1	1	2	3
TW, THHW, THW, THW-2	14	111	250	327	415	638	907
	12	85	192	251	319	490	696
	10	63	143	187	238	365	519
	8	35	79	104	132	203	288
RHH*,RHW*, WH-2*	14	74	166	217	276	424	603
RHH*, HW*, RHW-2*	12	59	134	175	222	341	485
	10	46	104	136	173	266	378
RHH*, HW*,RHW-2*	8	28	62	81	104	159	227
RHH*, RHW*, RHW-2*, TW, THW, THHW, THW-2	6	21	48	62	79	122	173
	4	16	36	46	59	91	129
	3	13	30	40	51	78	111
	2	11	26	34	43	66	94
	1	8	18	24	30	46	66
	1/0	7	15	20	26	40	56
	2/0	6	13	17	22	34	48
	3/0	5	11	14	18	28	40
	4/0	4	9	12	15	24	34
	250	3	7	10	12	19	27
	300	3	6	8	11	17	24
	350	2	6	7	9	15	21
	400	2	5	7	8	13	19
	500	1	4	5	7	11	16
	600	1	3	4	6	9	13
	700	1	3	4	5	8	11
	750	1	3	4	5	7	11
	800	1	3	3	4	7	10
	900	1	2	3	4	6	9
	1000	1	2	3	4	6	8
	1250	1	1	2	3	4	6
	1500	1	1	1	2	4	6
	1750	1	1	1	2	3	5
	2000	0	1	1	1	3	4

(continued)

TABLE 2.31 NEC Table C12: Maximum Number of Conductors in Type EB PVC Conduit (*Continued*)

CONDUCTORS							
Type	Conductor Size (AWG/kcmil)	Metric Designator (Trade Size)					
		53 (2)	78 (3)	91 (3½)	103 (4)	129 (5)	155 (6)
THHN, THWN, THWN-2	14	159	359	468	595	915	1300
	12	116	262	342	434	667	948
	10	73	165	215	274	420	597
	8	42	95	124	158	242	344
	6	30	68	89	114	175	248
	4	19	42	55	70	107	153
	3	16	36	46	59	91	129
	2	13	30	39	50	76	109
	1	10	22	29	37	57	80
	1/0	8	18	24	31	48	68
	2/0	7	15	20	26	40	56
	3/0	5	13	17	21	33	47
	4/0	4	10	14	18	27	39
	250	4	8	11	14	22	31
	300	3	7	10	12	19	27
	350	3	6	8	11	17	24
	400	2	6	7	10	15	21
	500	1	5	6	8	12	18
	600	1	4	5	6	10	14
700	1	3	4	6	9	12	
750	1	3	4	5	8	12	
800	1	3	4	5	8	11	
900	1	3	3	4	7	10	
1000	1	2	3	4	6	9	
FEP, FEPB, PFA, PFAH, TFE	14	155	348	454	578	888	1261
	12	113	254	332	422	648	920
	10	81	182	238	302	465	660
	8	46	104	136	173	266	378
	6	33	74	97	123	189	269
	4	23	52	68	86	132	188
3	19	43	56	72	110	157	
2	16	36	46	59	91	129	
PFA, PFAH, TFE	1	11	25	32	41	63	90
PFA, PFAH, TFE, Z	1/0	9	20	27	34	53	75
	2/0	7	17	22	28	43	62
	3/0	6	14	18	23	36	51
	4/0	5	11	15	19	29	42
Z	14	186	419	547	696	1069	1519
	12	132	297	388	494	759	1078
	10	81	182	238	302	465	660
	8	51	115	150	191	294	417
	6	36	81	105	134	206	293
	4	24	55	72	92	142	201
	3	18	40	53	67	104	147
	2	15	34	44	56	86	122
	1	12	27	36	45	70	99
XHH, XHHW, XHHW-2, ZW	14	111	250	327	415	638	907
	12	85	192	251	319	490	696
	10	63	143	187	238	365	519
	8	35	79	104	132	203	288
	6	26	59	77	98	150	213
	4	19	42	56	71	109	155
	3	16	36	47	60	92	131
	2	13	30	39	50	77	110
XHH, XHHW, XHHW-2	1	10	22	29	37	58	82
	1/0	8	19	25	31	48	69
	2/0	7	16	20	26	40	57
	3/0	6	13	17	22	33	47
	4/0	5	11	14	18	27	39
	250	4	9	11	15	22	32
	300	3	7	10	12	19	28
	350	3	6	9	11	17	24
	400	2	6	8	10	15	22
	500	1	5	6	8	12	18
	600	1	4	5	6	10	14
	700	1	3	4	6	9	12
	750	1	3	4	5	8	12
	800	1	3	4	5	8	11
	900	1	3	3	4	7	10
	1000	1	2	3	4	6	9
	1250	1	1	2	3	5	7
	1500	1	1	1	3	4	6
	1750	1	1	1	2	4	5
	2000	0	1	1	1	3	5

Note: This table is for concentric stranded conductors only. For compact stranded conductors, Table C12(A) should be used.

*Types RHH, RHW, and RHW-2 without outer covering.

(© 2001, NFPA)

NOTES

A large grid area for taking notes, consisting of a 20x20 grid of small squares. The grid is empty and occupies the majority of the page below the 'NOTES' header.

CHAPTER THREE

Service and Distribution

3.0 PRIMARY AND SECONDARY SERVICE AND SYSTEM CONFIGURATIONS

Introduction

To provide electrical service to a building or buildings, you must first determine what type of system is available from the utility company, or from a privately owned and operated system, such as might be found on a college or university campus, industrial or commercial complex, as the case may be. Once this is known, it is important to understand the characteristics of the system—not only voltage, capacity, and available fault current, but the operational, reliability, and relative cost characteristics inherent in the system by virtue of its configuration or arrangement. Knowing the characteristics associated with the system arrangement, the most appropriate service and distribution system for the application at hand can be determined.

Figures 3.1 through 3.10 feature the most frequently encountered system configurations and associated key characteristics attributable to their arrangement.

FIGURE 3.1 Radial circuit arrangements in commercial buildings. (Adapted from IEEE Std. 241-1990. Copyright 1990 IEEE. All rights reserved.)

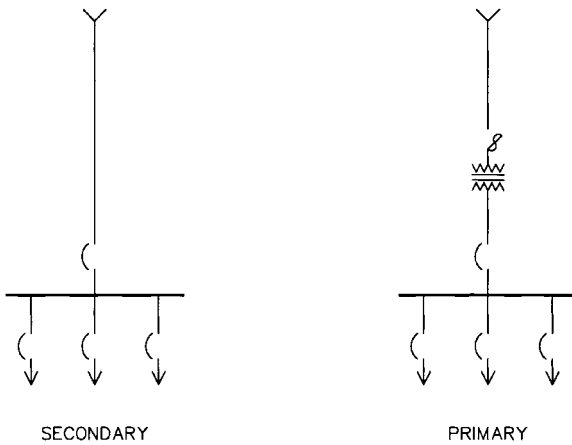

Characteristics:

- Simplest and lowest cost way of distributing power.
- Lowest reliability. A fault in the supply circuit, transformer, or the main bus will cause interruption of service to all loads.
- Modern distribution equipment has demonstrated sufficient reliability to justify use of the radial circuit arrangement in many applications.
- Most commonly used circuit arrangement.

FIGURE 3.2 Radial circuit arrangement—common primary feeder to secondary unit substations. (Adapted from IEEE Std. 241-1990. Copyright 1990 IEEE. All rights reserved.)

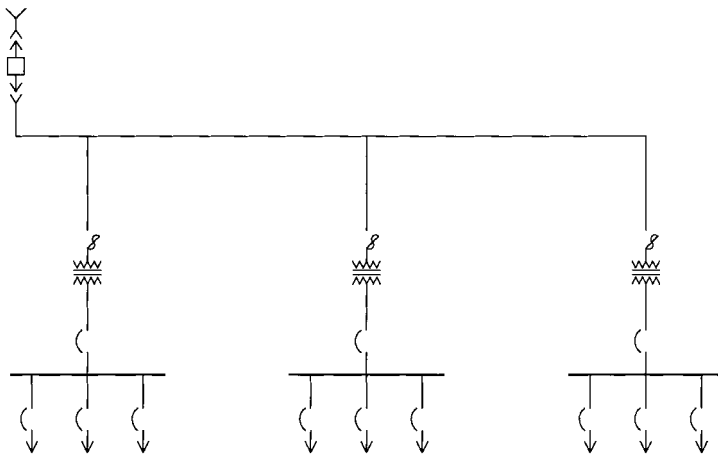

Characteristics:

- Multiple small rather than single large secondary substation.
- Used when demand, size of building, or both may be required to maintain adequate voltage at the utilization equipment.
- Smaller substations located close to center of load area.
- Provides better voltage conditions, lower system losses, less expensive installation cost than using relatively long, high-amperage, low-voltage feeder circuits.
- A primary feeder fault will cause the main protective device to operate and interrupt service to all loads. Service cannot be restored until the source of trouble has been eliminated.
- If a fault were in a transformer, service could be restored to all loads except those served by that transformer.

FIGURE 3.3 Radial circuit arrangement—individual primary feeders to secondary unit substations. (Adapted from IEEE Std. 241-1990. Copyright 1990 IEEE. All rights reserved.)

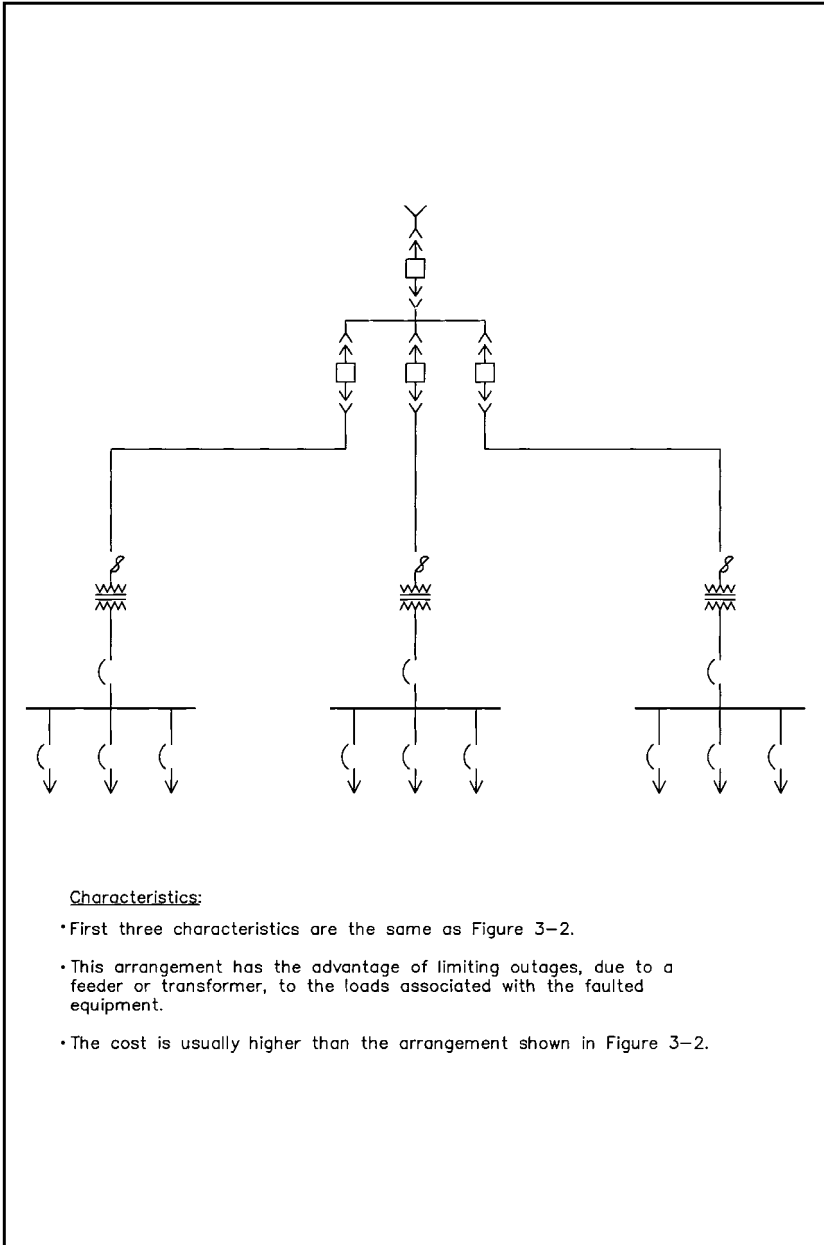

FIGURE 3.4 Primary radial-selective arrangements. (Adapted from IEEE Std. 241-1990. Copyright 1990 IEEE. All rights reserved.)

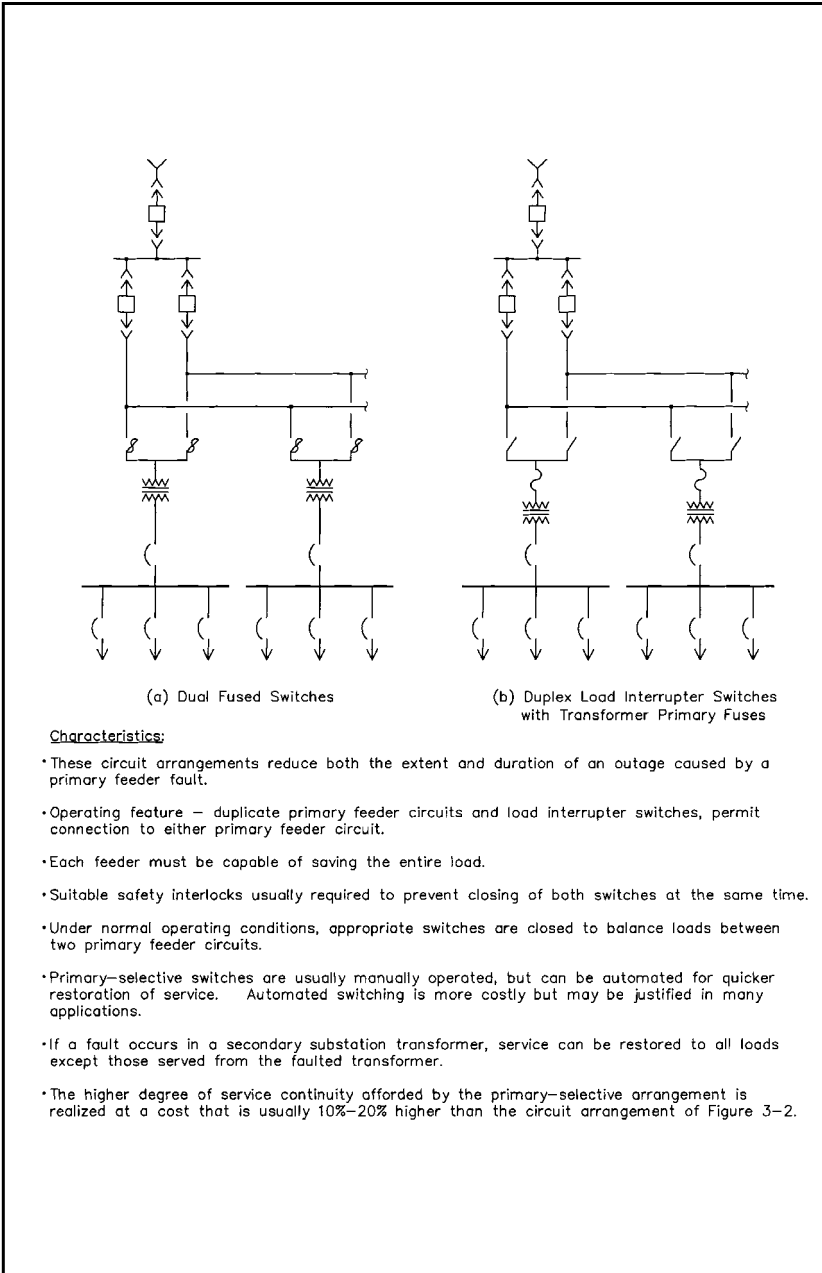
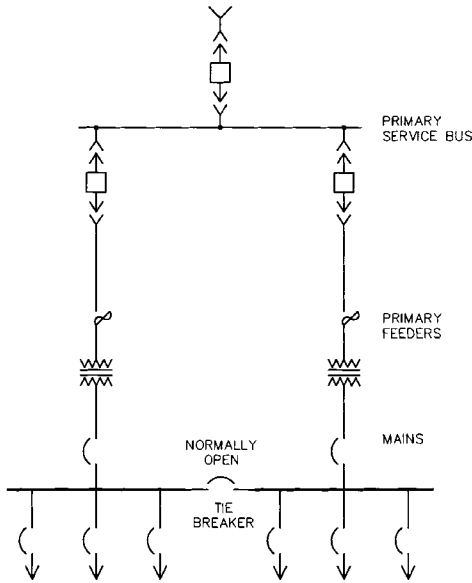

FIGURE 3.5 Secondary-selective circuit arrangement (double-ended substation with single tie). (Adapted from IEEE Std. 241-1990. Copyright 1990 IEEE. All rights reserved.)



Characteristics:

- Under normal conditions, operates as two separate radial systems with the secondary bus-tie circuit breaker normally open.
- Loads should be divided equally between the two bus sections.
- If a fault occurs on a primary feeder or in a transformer, service is interrupted to all loads served from that half of the double-ended arrangement. Service can be restored to all secondary buses by opening the secondary main on the faulted side and closing the tie breaker.
- The main-tie-main breakers are normally interlocked to prevent paralleling the transformers and to prevent closing into a secondary bus fault. They can also be automated to transfer to standby operation and retransfer to normal operation.
- Cost of this arrangement will depend upon the spare capacity in the transformers and primary feeders. The minimum will be determined by the essential loads that need to be served under standby operating conditions. If service is to be provided for all loads under standby conditions, then the primary feeders and transformers must be capable of carrying the total load on both substation buses.
- This circuit arrangement is more expensive than either the radial or primary selective circuit configuration. This is primarily due to the redundant transformers.

FIGURE 3.6 Secondary-selective circuit arrangement (individual substations with interconnecting ties). (Adapted from IEEE Std. 241-1990. Copyright 1990 IEEE. All rights reserved.)

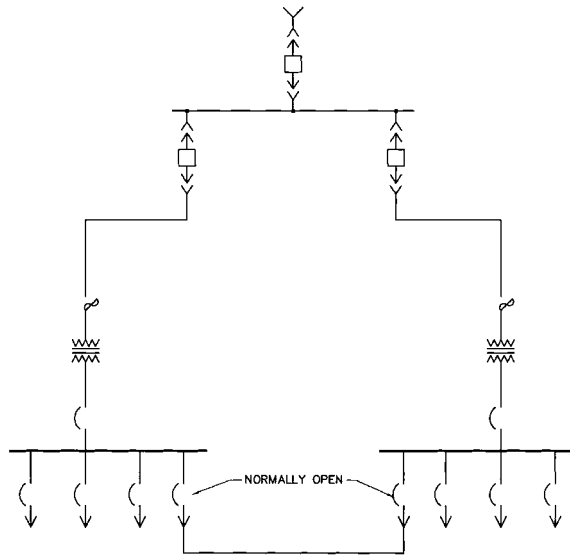

Characteristics:

- In this modification of the secondary-selective circuit arrangement shown in Figure 3-5, there is only one transformer in each secondary substation; but adjacent substations are interconnected in pairs by a normally open low-voltage tie circuit.
- When the primary feeder or transformer supplying one secondary substation bus is out of service, essential loads on that substation bus can be supplied over the tie circuit.
- Operating aspects of this system are somewhat complicated if the two substations are separated by distance.
- This would not be a desirable choice in a new building service design because a multiple key interlock system would be required to avoid tying the two substations together while they were both energized.

FIGURE 3.7 Primary- and secondary-selective circuit arrangement (double-ended substation with selective primary). (Adapted from IEEE Std. 241-1990. Copyright 1990 IEEE. All rights reserved.)

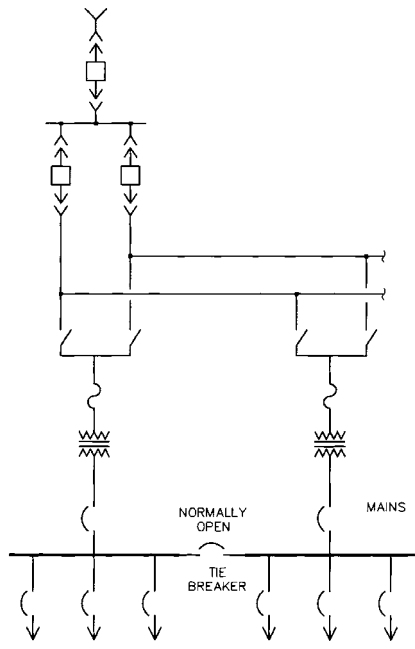

Characteristics:

- Used when highly reliable service is needed, such as hospital or data center loads.
- Has the combined benefits and characteristics of the arrangements shown in Figure 3-4 and 3-5.
- Small premium cost over configuration shown in Figure 3-5 for primary selector switches.

FIGURE 3.8 Looped primary circuit arrangement. (Adapted from IEEE Std. 241-1990. Copyright 1990 IEEE. All rights reserved.)

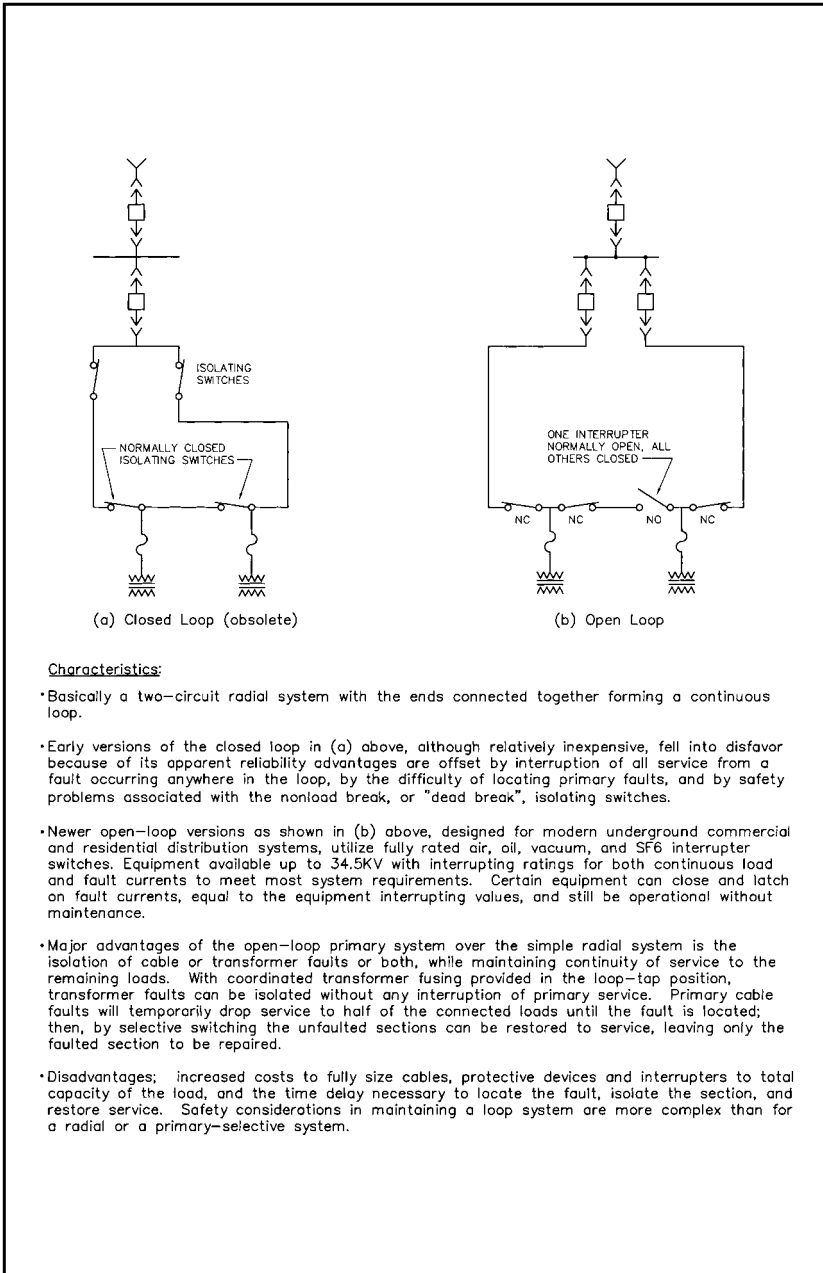
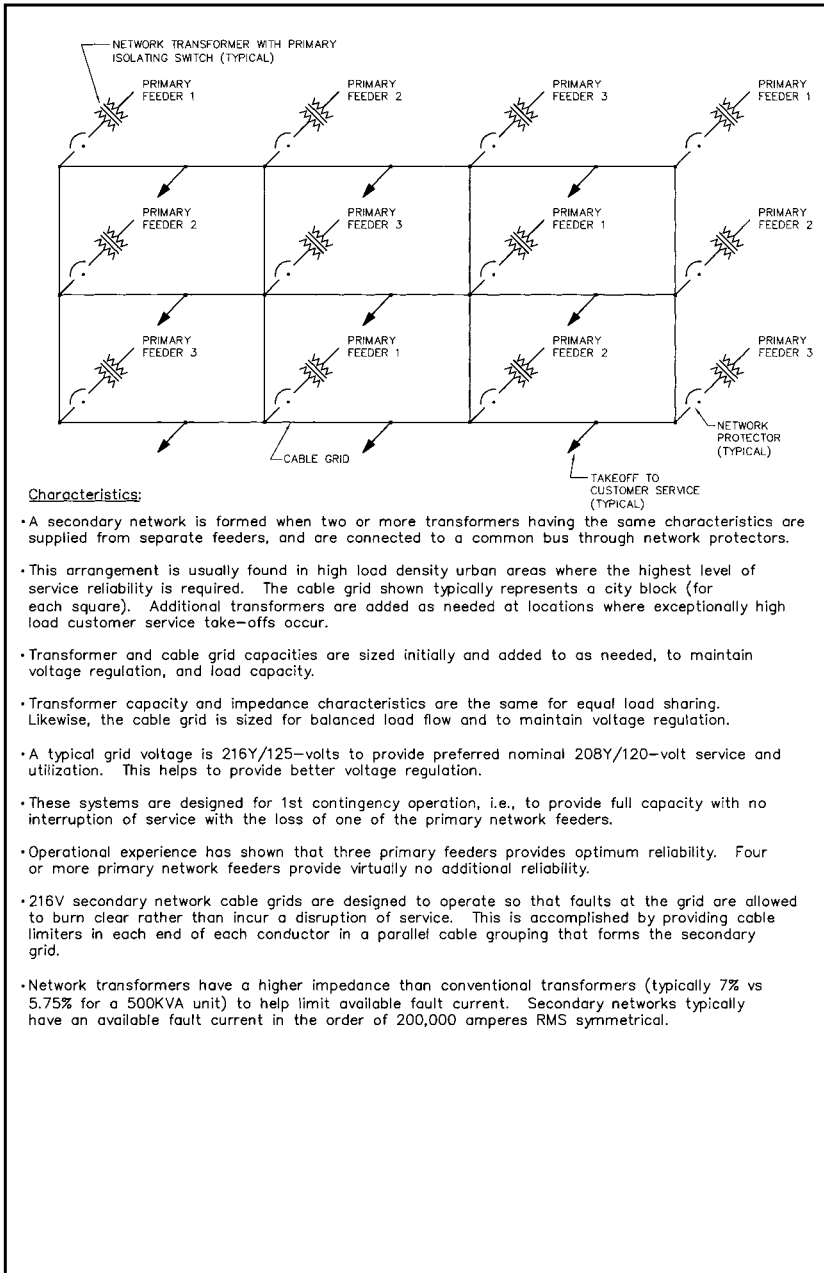

FIGURE 3.9 Distributed secondary network. (Adapted from IEEE Std. 241-1990. Copyright 1990 IEEE. All rights reserved.)



Characteristics:

- A secondary network is formed when two or more transformers having the same characteristics are supplied from separate feeders, and are connected to a common bus through network protectors.
- This arrangement is usually found in high load density urban areas where the highest level of service reliability is required. The cable grid shown typically represents a city block (for each square). Additional transformers are added as needed at locations where exceptionally high load customer service take-offs occur.
- Transformer and cable grid capacities are sized initially and added to as needed, to maintain voltage regulation, and load capacity.
- Transformer capacity and impedance characteristics are the same for equal load sharing. Likewise, the cable grid is sized for balanced load flow and to maintain voltage regulation.
- A typical grid voltage is 216Y/125-volts to provide preferred nominal 208Y/120-volt service and utilization. This helps to provide better voltage regulation.
- These systems are designed for 1st contingency operation, i.e., to provide full capacity with no interruption of service with the loss of one of the primary network feeders.
- Operational experience has shown that three primary feeders provides optimum reliability. Four or more primary network feeders provide virtually no additional reliability.
- 216V secondary network cable grids are designed to operate so that faults at the grid are allowed to burn clear rather than incur a disruption of service. This is accomplished by providing cable limiters in each end of each conductor in a parallel cable grouping that forms the secondary grid.
- Network transformers have a higher impedance than conventional transformers (typically 7% vs 5.75% for a 500KVA unit) to help limit available fault current. Secondary networks typically have an available fault current in the order of 200,000 amperes RMS symmetrical.

FIGURE 3.10 Basic spot network. (Adapted from IEEE Std. 241-1990. Copyright 1990 IEEE. All rights reserved.)

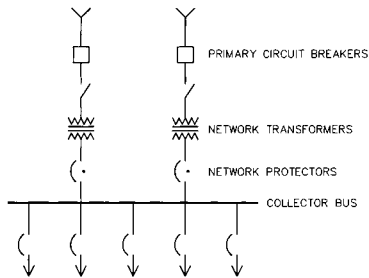

Characteristics:

- The spot network is a localized distribution center consisting of two or more transformer/network protector units connected to a common bus called a "collector bus". A building may have one or more spot network services.
- Spot networks are employed to provide a reliable source of power to important electrical loads. Spare capacity is built in to allow for at least one contingency, i.e., loss of a transformer or primary network feeder will cause no interruption of service.
- Planning for service continuity should be extended beyond the consideration of using a utility primary feeder or transformer. The consequences of severe equipment damage including the resulting system downtime, should also be considered.
- The primary side of a spot network transformer usually contains an isolating/load interrupter switch, primary fuses, and a non-load break grounding switch located within the same enclosure. Although the grounding switch has a fault closing rating, it cannot be operated until the safety requirements of a key interlock scheme have been satisfied. The key interlocks prevent closing the grounding switch until all possible sources of supply to the feeder have been isolated.
- Conventional automatic network protectors are sophisticated devices. They are self-contained units consisting of an electrically operated circuit breaker, special network relays, control transformers, instrument transformers, and open-type fuse links. The protector will automatically close when the oncoming transformer voltage is greater than the collector bus voltage and will open when reverse current flows from the collector bus into the transformer. Reverse current flow can be the result of a fault beyond the line side of the protector, supplying load current back into the primary distribution system when the collector bus voltage is higher than the individual transformer voltage, or the opening of the transformer primary feeder breaker, which causes the collector bus to supply transformer magnetizing current via the transformer secondary winding.
- Most spot network applications for commercial buildings provide 480Y/277-volt utilization, thus requiring ground fault protection. Relay protection is the most common method of ground-fault protection. The fault current may be sensed by the ground return, residual, or zero-sequence method. Each of the methods have proved successful where appropriately applied; but they share a common limitation in that they cannot distinguish between in-zone and thru-zone ground faults unless incorporated in a complex protection scheme. One particular method of ground-fault detection that is not prone to unnecessary tripping is enclosure monitoring. This method offers the distinct advantage of not requiring coordination with other protective devices.

3.1 PRELIMINARY LOAD CALCULATIONS

Introduction

The electrical design professional should determine a building's electrical load characteristics early in the preliminary design stage of the building to select the proper power distribution system and equipment having adequate power capacity with proper voltage levels, and sufficient space and ventilation to maintain proper ambients. Once the power system is determined, it is often difficult to make major changes because of the coordination required with other disciplines. Architects and mechanical and structural engineers will be developing their designs simultaneously and making space and ventilation allocations. It is imperative, therefore, from the start that the electric systems be correctly based on realistic load data or best possible typical load estimates, or both because all final, finite load data are not available during the preliminary design stage of the project. When using estimated data, it should be remembered that the typical data applies only to the condition from which the data was taken, and most likely an adjustment to the particular application will be required.

Although many of the requirements of building equipment, such as ventilating, heating/cooling, lighting, and so forth, are furnished by other disciplines, the electrical design professional should also furnish to the other disciplines such data as space, accessibility, weight, and heat dissipation requirements for the electrical power distribution apparatus. This involves a continuing exchange of information that starts as preliminary data and is upgraded to be increasingly accurate as the design progresses. Documentation and coordination throughout the design process is imperative.

At the beginning of a project, the electrical design professional should review the utility's rate structure and the classes (system types) of service available. Information pertaining to demand, energy, and power factor should be developed to aid in evaluating, selecting, and specifying the most advantageous utility connection. As energy resources become more costly and scarce, items such as energy efficiency, power demand minimization, and energy conservation should be closely considered to reduce both energy consumption and utility cost.

System power (i.e., energy) losses should be considered as part of the total load in sizing service mains and service equipment. ANSI/NFPA 70-2002, NEC recommends that the total voltage drop from the electrical service to the load terminals of the farthest piece of equipment served should not exceed 5 percent of the system voltage and, thus, the energy loss, I^2R , will correspondingly be limited.

Listed hereafter are typical load groups and examples of classes of electrical equipment that should be considered when estimating initial and future loads.

- *Lighting*: Interior (general, task, exits, and stairwells), exterior (decorative, parking lot, security), normal, and emergency
- *Appliances*: Business and copying machines, receptacles for vending machines, and general use
- *Space conditioning*: Heating, cooling, cleaning, pumping, and air-handling units
- *Plumbing and sanitation*: Water pumps, hot water heaters, sump and sewage pumps, incinerators, and waste handling
- *Fire protection*: Fire detection, alarms, and pumps
- *Transportation*: Elevators, dumbwaiters, conveyors, escalators, and moving walkways
- *Data processing*: Desktop computers, central processing and peripheral equipment, and uninterruptible power supply (UPS) systems, including related cooling
- *Food preparation*: Cooling, cooking, special exhausts, dishwashing, disposing, and so forth
- *Special loads*: For equipment and facilities in mercantile buildings, restaurants, theaters, recreation and sports complexes, religious buildings, terminals and airports, health care facilities, laboratories, broadcasting stations, and so forth
- *Miscellaneous loads*: Security; central control systems; communications; audio-visual, snow-melting, recreational, or fitness equipment; incinerators, shredding devices, waste compactors, shop and maintenance equipment, and so forth

Load Estimates

There are several load estimates that should be made during the course of the project including:

1. Preliminary load estimate
2. Early design load estimate
3. NEC compliance load estimates that may be required
4. Energy compliance load estimates that may be appropriate
5. Final load estimates based on final design load information

The following tables are provided to assist the user in estimating preliminary loads for various building types. Considerable judgment should be used in the application of this data. Power densities are typically given in watts per square foot (W/ft^2) or volt-amps per square foot (VA/ft^2) and are used interchangeably because unity power factor is assumed for preliminary load calculations.

In the first of the tables that follow, criteria for controlling the energy

consumption of lighting systems in, and connected with, building facilities have been prepared by the American Society of Heating, Refrigerating, and Air-Conditioning Engineers (ASHRAE) in concert with the Illuminating Engineering Society of North America (IESNA). They are identified in Section 6 of ASHRAE/IESNA 90.1-1989, Energy Efficient Design of New Buildings Except New Low-Rise Residential Buildings, which establishes an upper limit of power to be allowed for lighting systems plus guidelines for designing and managing those systems. A simplified method based on the above standard for determining the unit lighting power allowance for each building type is shown in Table 3.1.

The remaining tables provide power densities for various types of loads and building types. See Tables 3.2 through 3.10.

The foregoing tables give estimated connected loads for various types of buildings and spaces in buildings. To these the user must apply a demand factor to estimate the actual demand load. This requires experience and judgment. Applying a demand factor will help to design an economical power distribution system by designing to demand loads rather than connected loads. This will result in equipment that is appro-

TABLE 3.1 Prescriptive Unit Lighting Power Allowance (ULPA) (w/ft²)—Gross Lighted Area of Total Building

Building Type or Space Activity	0 to 2000 ft ²	2001 to 10 000 ft ²	10 001 to 25 000 ft ²	25 001 to 50 000 ft ²	50 001 to 250 000 ft ²	> 250 000 ft ²
Food Service						
Fast Food/Cafeteria	1.50	1.38	1.34	1.32	1.31	1.30
Leisure Dining/Bar	2.20	1.91	1.71	1.56	1.46	1.40
Offices	1.90	1.81	1.72	1.65	1.57	1.50
Retail*	3.30	3.08	2.83	2.50	2.28	2.10
Mall Concourse	1.60	1.58	1.52	1.46	1.43	1.40
Multiple-Store Service						
Service Establishment	2.70	2.37	2.08	1.92	1.80	1.70
Garages	0.30	0.28	0.24	0.22	0.21	0.20
Schools						
Preschool/Elementary	1.80	1.80	1.72	1.65	1.57	1.50
Jr. High/High School	1.90	1.90	1.88	1.83	1.76	1.70
Technical/Vocational	2.40	2.33	2.17	2.01	1.84	1.70
Warehouse/Storage	0.80	0.66	0.56	0.48	0.43	0.40

NOTE: *Includes general, merchandising, and display lighting.

This prescriptive table is intended primarily for core-and-shell (i.e., speculative) buildings or for use during the preliminary design phase (i.e., when the space uses are less than 80% defined). The values in this table are not intended to represent the needs of all buildings within the types listed.

Reprinted from ASHRAE/IES 90.1-1989, Energy Efficient Design of New Buildings Except New Low-Rise Residential Buildings. Used with the permission of ASHRAE.

TABLE 3.2 Typical Appliance/General-Purpose Receptacle Loads (Excluding Plug-In-Type A/C and Heating Equipment)

Type of Occupancy	Unit Load (VA/ft ²)		
	Low	High	Average
Auditoriums	0.1	0.3	0.2
Cafeterias	0.1	0.3	0.2
Churches	0.1	0.3	0.2
Drafting rooms	0.4	1.0	0.7
Gymnasiums	0.1	0.2	0.15
Hospitals	0.5	1.5	1.0
Hospitals, large	0.4	1.0	0.7
Machine shops	0.5	2.5	1.5
Office buildings	0.5	1.5	1.0
Schools, large	0.2	1.0	0.6
Schools, medium	0.25	1.2	0.7
Schools, small	0.3	1.5	0.9
Other Unit Loads:			
Specific appliances — ampere rating of appliance			
Supplying heavy-duty lampholders — 5 A/outlet			

TABLE 3.3 Typical Apartment Loads

Type	Load
Lighting and convenience outlets (except appliance)	3 VA/ft ²
Kitchen, dining appliance circuits	1.5 kVA each
Range	8 to 12 kW
Microwave oven	1.5 kW
Refrigerator	0.3 to 0.6 kW
Freezer	0.3 to 0.6 kW
Dishwasher	1.0 to 2.0 kW
Garbage disposal	0.33 to 0.5 hp
Clothes washer	0.33 to 0.5 hp
Clothes dryer	1.5 to 6.5 kW
Water heater	1.5 to 9.0 kW
Air conditioner (0.5 hp/room)	0.8 to 4.6 kW

TABLE 3.4 Typical Connected Electrical Load for Air Conditioning Only

Type of Building	Conditioned Area (VA/ft ²)
Bank	7
Department store	3 to 5
Hotel	6
Office building	6
Telephone equipment building	7 to 8
Small store (shoe, dress, etc.)	4 to 12
Restaurant (not including kitchen)	8

TABLE 3.5 Central Air Conditioning Watts per SF, BTUs per Hour per SF of Floor Area and SF per Ton of Air Conditioning

Type Building	Watts per S.F.	BTUH per S.F.	S.F. per Ton	Type Building	Watts per S.F.	BTUH per S.F.	S.F. per Ton	Type Building	Watts per S.F.	BTUH per S.F.	S.F. per Ton
Apartments, Individual	3	26	450	Dormitory, Rooms	4.5	40	300	Libraries	5.7	50	240
Corridors	2.5	22	550	Corridors	3.4	30	400	Low Rise Office, Ext.	4.3	38	320
Auditoriums & Theaters	3.3	40	300/18*	Dress Shops	4.9	43	280	Interior	3.8	33	360
Banks	5.7	50	240	Drug Stores	9	80	150	Medical Centers	3.2	28	425
Barber Shops	5.5	48	250	Factories	4.5	40	300	Motels	3.2	28	425
Bars & Taverns	15	133	90	High Rise Off-Ext. Rms.	5.2	46	263	Office (small suite)	4.9	43	280
Beauty Parlors	7.6	66	180	Interior Rooms	4.2	37	325	Post Office, Int. Office	4.9	42	285
Bowling Alleys	7.8	68	175	Hospitals, Core	4.9	43	280	Central Area	5.3	46	260
Churches	3.3	36	330/20*	Perimeter	5.3	46	260	Residences	2.3	20	600
Cocktail Lounges	7.8	68	175	Hotels, Guest Rooms	5	44	275	Restaurants	6.8	60	200
Computer Rooms	16	141	85	Public Spaces	6.2	55	220	Schools & Colleges	5.3	46	260
Dental Offices	6	52	230	Corridors	3.4	30	400	Shoe Stores	6.2	55	220
Dept. Stores, Basement	4	34	350	Industrial Plants, Offices	4.3	38	320	Shop'g. Ctrs., Sup. Mkts.	4	34	350
Main Floor	4.5	40	300	General Offices	4	34	350	Retail Stores	5.5	48	250
Upper Floor	3.4	30	400	Plant Areas	4.5	40	300	Specialty Shops	6.8	60	200

*Persons per ton

12,000 BTUH = 1 ton of air conditioning

TABLE 3.6 All-Weather Comfort Standard Recommended Heat Loss Values

Degree Days	Design Heat Loss per Square Foot of Floor Area	
	(Btu/h)	(watts)
Over 8000	40	11.7
7001 to 8000	38	11.3
6001 to 7000	35	10.3
5001 to 6000	32	9.4
3001 to 5000	30	8.8
Under 3001	28	8.2

TABLE 3.7 Typical Power Requirement (kW) for High-Rise Building Water Pressure-Boosting Systems

Building Type	Unit Quantity	Number of Stories			
		5	10	25	50
Apartments	10 apt./ floor	—	15	90	350
Hospitals	30 patients/ floor	10	45	250	—
Hotels/ Motels	40 rooms/ floor	7	35	175	450
Offices	10 000 ft ² / floor	—	15	75	250

TABLE 3.8 Typical Power Requirement (kW) for Electric Hot Water-Heating System

Building Type	Unit Quantity	Load
Apartments/ Condominiums	20 apt/condo	30
Dormitories	100 residents	75
Elementary schools	100 students	6
High schools	100 students	12
Restaurant (full service)	100 servings/h	30
Restaurant (fast service)	100 servings/h	15
Nursing homes	100 residents	60
Hospitals	100 patient beds	200
Office buildings	10 000 ft ²	5

TABLE 3.9 Typical Power Requirement (kW) for Fire Pumps in Commercial Buildings (Light Hazard)

Area/Floor (ft ²)	Number of Stories			
	5	10	25	50
5 000	40	65	150	250
10 000	60	100	200	400
25 000	75	150	275	550
50 000	120	200	400	800

* Based on zero pressure at floor 1.

proportionately sized rather than oversized to accommodate connected loads. Tables 3.11 and 3.12 give examples of demand loads.

Experience has shown that demand factors for buildings typically range between 50 and 80 percent of the connected load. For most building types, the demand factor at the service where the maximum diversity is experienced is usually 60 to 75 percent of the connected load. Specific portions of the system may have much higher demand factors, even approaching 100 percent.

The factors shown in Table 3.13 may be used in sizing the distribution system components shown for lighting demand and should result in a

TABLE 3.10 Typical Loads in Commercial Kitchens

	Number Served	Connected Load (kW)
Lunch counter (gas ranges, with 40 seats)		30
Cafeteria	800	150
Restaurant (gas cooking)		90
Restaurant (electric cooking)		180
Hospital (electric cooking)	1200	300
Diet kitchen (gas cooking)		200
Hotel (typical)		75
Hotel (modern, gas ranges, three kitchens)		150
Penitentiary (gas cooking)		175

TABLE 3.11 Comparison of Maximum Demand

Type of Store	Shopping Center A, New Jersey No Refrigeration*		Shopping Center B, New Jersey Refrigeration		Shopping Center C, New York Refrigeration	
	Gross Area (ft ²)	(W/ft ²)	Gross Area (ft ²)	(W/ft ²)	Gross Area (ft ²)	(W/ft ²)
Bank					4000	9.0
Book	3700	6.0	2500	6.7		
Candy	1600	6.9			2000	10.8
Department	343 500	4.7	222 000	7.3	226 900	8.0
	84 000	3.1	114 000	5.6		
Drug	7000	6.1	6000	7.7		
Men's wear	17 000	5.5	17 000	9.9	2000	10.8
	28 000	4.9	9100	8.8		
Paint					15 600	8.5
Pet					2000	12.1
Restaurant					4000	9.0
Shoe	11 000	6.3	7000	12.5	3300	15.4
	4000	8.0	4400	12.9	2100	9.0
Supermarket	32 000	5.7	25 000	8.6	37 600	11.5
Variety	31 000	4.6	24 000	6.8	37 400	7.1
	30 000	4.4			30 000	7.0
Women's wear	20 400	4.7	19 300	8.9	1360	13.0
	1000	5.8	4500	9.6	1000	11.7

*Loads include all lighting and power, but no power for air-conditioning refrigeration (chilled water), which is supplied from a central plant.

TABLE 3.12 Connected Load and Maximum Demand by Tenant Classification

Classification	Connected Load (W/ft ²)	Maximum Demand (W/ft ²)	Demand Factor
10 Women's wear	7.7	5.9	0.75
3 Men's wear	7.2	5.6	0.78
6 Shoe store	8.5	6.9	0.79
2 Department store	6.0	4.7	0.74
2 Variety store	10.5	4.5	0.45
2 Drug store	11.7	6.7	0.57
5 Household goods	5.4	3.9	0.76
10 Specialty shop	8.1	6.8	0.79
4 Bakery and candy	17.1	12.1	0.71
3 Food store (supermarkets)	9.9	5.9	0.60
5 Restaurant	15.9	7.1	0.45

NOTE: Connected load includes an allowance for spares.

TABLE 3.13 Factors Used in Sizing Distribution System Components

Distribution System Component	Lighting Demand Factor
Lighting panelboard buss and main overcurrent device	1.0
Lighting panelboard feeder and feeder overcurrent device	1.0
Distribution panelboard buss and main overcurrent device	
First 50 000 W or less	0.5
All over 50 000 W	0.4
Remaining components	0.4

conservative design. The factors should be applied to connected lighting load in the first step, and then to the product resulting from previous steps as the designer proceeds through the system.

The types of heating, ventilating, and air-conditioning systems chosen for a specific building will have the greatest single effect on electrical load. First, the choice of fuel will be critical. If natural gas, fuel oil, or coal is chosen, electrical loads will be lower than would be the case if electricity were chosen. Second, the choice of refrigeration cycle will have a considerable impact. If absorption chillers are chosen, electrical loads will be lower than those imposed by electric centrifugal or reciprocating chillers.

For initial estimates, before actual loads are known, the factors shown in Table 3.14 may be used to establish the major elements of the electrical system serving HVAC primary cooling systems.

In the writer's experience, a factor of 1.7 kVA/ton provides a good estimate for a primary cooling system made up of electric centrifugal chillers, chilled water pumps, condenser water pumps, and cooling tower fans.

TABLE 3.14 Factors Used to Establish Major Elements of the Electrical System Serving HVAC Systems

Item	Unit
Refrigeration Machines:	kVA/Ton of Chiller Capacity
Absorption	
Centrifugal	1.00
Reciprocating	
Auxiliary Pumps & Fans:	
Chilled Water Pumps	0.08
Condenser Water Pumps	
Absorption	
Centrifugal/Reciprocating	0.07
Cooling Tower Fans	
Absorption	
Centrifugal/Reciprocating	0.07
Boilers:	kVA/Boiler Horsepower
Natural Gas/Fuel Oil	0.07
Coal	
Boiler Auxiliary Pumps:	kVA/Boiler Horsepower
Deaerator	0.10
Auxiliary Equipment:	kVA/Bed
Clinical Vacuum Pumps	0.18
Clinical Air Compressors	0.10

To estimate loads for commercial kitchens, the choice of fuel in the kitchen is a major determinant. If natural gas is the primary fuel, electrical loads will be lower on a watts-per-square-foot basis than where electricity is the primary fuel. For estimating purposes, the following factors may be used as an alternative to those shown in Table 3.10. In calculating kitchen floor area include cooking and preparation, dish-washing, storage, walk-in refrigerators and freezers, food serving lines, tray assembly, and offices.

<i>Primary Fuel</i>	<i>Watts/Square Foot</i>
Natural gas	25
Electricity	125

A tabulation of actual service entrance demand per gross square foot is presented in Tables 3.15 and 3.16 for a group of health care facilities. Data used in preparation of these tables was obtained from the Veteran’s Administration and Hospital Corporation of America. Refer to footnotes accompanying the tables for the criteria on which these tables are based.

The tables show the type of facility, the gross floor area and number of beds for each, the geographic location, and the major fuel type employed for HVAC systems in that facility. The derived factors may be used to estimate the anticipated demand for other facilities similar in size, location, and type of fuel. They also may be used to make initial estimates of service entrance capacity, switchgear size, and space required for service entrance equipment. It is important to recognize, however, that they will be useful principally in the schematic design

TABLE 3.15 Service Entrance Peak Demand (Veterans Administration)

Hospital	Floor Area Square Feet	Beds*	Degree Days [†]		Principal [†] Fuel-HVAC	Watts Per Sq ft [§]	
			Cooling	Heating		Maximum	Average
V.A. Hospital #1	821 000	922	234	3536	NG/FO	4.5	3.5
V.A. Hospital #2	334 000	500	863	5713	NG/FO	5.2	3.9
V.A. Hospital #3	645 995	670	3488	1488	NG/FO	3.8	2.8
V.A. Hospital #4	681 000	600	1016	654	NG/FO	6.1	4.0
V.A. Hospital #5	503 500	697	3495	841	NG/FO	7.2	5.5
V.A. Hospital #6	800 000	1050	600	7400	NG/FO	5.9	4.2

* Total beds shown. Beds actually occupied could affect values shown for watts per square foot.

[†] Degree Days: Normals, Base 65 °F, based on 1941-70 period. From *Local Climatological Data Series*, 1974, NOAA.

[†] NG/FO = Natural Gas/Fuel Oil. In all cases, electricity was the fuel used for refrigeration.

[§] Watts per square foot based on measured values at service entrance during metering periods ranging from 9 to 17 days, during cooling season in all instances, 1981.

TABLE 3.16 Service Entrance Peak Demand (Hospital Corporation of America)

Hospital and Location	Floor Area Square Feet	Beds*	Degree Days [†]		Principal [‡] Fuel-HVAC	Watts Per Sq ft [§] Maximum
			Cooling	Heating		
#1 — East	273 000	458	1353	3939	NG/FO	6.8
#2 — Southeast	278 000	250	2294	2240	NG/FO	6.3
#3 — Central	123 000	157			NG/FO	7.5
#4 — Central	36 365	62	2029	3227	E	13.7
#5 — Central	318 000	300	1107	4306	NG/FO	4.6
#6 — Southeast	182 000	225	3786	299	NG/FO	5.3
#7 — East	283 523	320	1030	4307	NG/FO	6.8
#8 — Southwest	135 396	150	2250	2621	NG/FO	6.6
#9 — West	190 000	97	927	5983	NG/FO	2.8
#10 — Southeast	161 000	170	3226	733	NG/FO	6.3
#11 — Southeast	157 639	214	2078	2146	NG/FO	7.3
#12 — Southeast	162 187	222	2143	2378	NG/FO	4.3
#13 — East	109 617	146	1030	4307	NG/FO	5.7
#14 — East	76 000	153	1030	4307	E	8.8
#15 — Southeast	135 150	190	1995	2547	NG/FO	5.9
#16 — Southwest	75 769	131	2587	2382	NG/FO	7.4
#17 — Central	75 769	128	1636	3505	NG/FO	6.3
#18 — Northwest	129 000	150	714	5833	NG/FO	4.4
#19 — Central	54 938	108	1694	3696	E	13.3
#20 — West	144 000	160	2814	1752	NG/FO	4.5
#21 — Southeast	149 000	123	2078	2146	NG/FO	4.5
#22 — Central	89 000	128	2029	3227	E	8.4
#23 — Central	128 500	150	1197	4729	NG/FO	6.2
#24 — West	135 169	170	927	5983	NG/FO	4.7
#25 — Southeast	80 000	124	1722	2975	NG/FO	6.2
#26 — Southeast	83 117	126	3226	733	NG/FO	8.5
#27 — Central	51 000	97	1569	3478	E	8.8
#28 — Southeast	66 528	120	2929	902	E	9.7
#29 — East	112 000	140	1394	3514	NG/FO	4.3
#30 — Central	202 000	223	1636	3505	NG/FO	4.8
#31 — Southeast	56 000	51	3786	299	NG/FO	7.4
#32 — West	47 434	50	927	5983	NG/E	7.0
#33 — Central	23 835	32	1694	3696	E	10.8
#34 — Southeast	105 000	95	2706	1465	NG/FO	8.3
#35 — West	48 575	60	3042	108	NG/E	7.7
#36 — Southwest	133 000	185	2587	2382	NG/FO	6.3
#37 — Central	42 879	66	1694	3696	E	15.7

* Total beds shown. Beds actually occupied could affect values shown for watts per square foot.

† Degree Days: Normals, Base 65 °F, based on 1941-70 period. From *Local Climatological Data Series*, 1974, NOAA.

‡ NG/FO = Natural Gas/Fuel Oil; E = Electricity. Principal fuel is defined as that used for heating. In all cases, electricity was the fuel used for refrigeration.

§ Watts per square foot based on measured values by utility company meter at service entrance, 1977.

|| Data shown for nearest recorded location.

(Each facility was self-contained, in that refrigeration and air conditioning equipment loads are included in power demands shown.)

phase. As the design proceeds through the preliminary and working drawing phases, these initial estimates should be modified by the actual conditions prevalent in the project.

3.2 SECONDARY VOLTAGE SELECTION

Introduction

Selection of the principal secondary utilization voltage is critical and should be made early in the preliminary design stage of a project. This is a critical decision because it has a significant impact on the cost of the distribution system, distribution equipment, and energy efficiency. The considerations are the same whether new service and distribution systems for a new building are to be considered or a renovation or addition to an existing building is considered. The options in the case of the latter, however, generally offer more limited choices.

Voltage Selection Considerations

The most prevalent secondary distribution voltage in commercial and institutional buildings today is 480Y/277 V, with a solidly grounded neutral. It is also a very common voltage in industrial plants and even in some high-rise, centrally air-conditioned and electrically heated residential buildings, because of the large loads.

The choice between 208Y/120-V and 480Y/277-V secondary distribution for commercial and institutional buildings depends on several factors. The most important of these are size and types of loads and the length of feeders. In general, large motor and fluorescent lighting loads, and long feeders, will tend to make the higher voltages, such as 480Y/277 V, more economical. Very large loads and long runs would indicate the use of medium-voltage distribution and load center unit substations close to the loads. Conversely, small loads, short runs, and a high percentage of incandescent lighting would favor lower utilization voltages such as 208Y/120 V.

The principal advantages of using higher secondary voltages in buildings are:

- Smaller conductors
- Lower voltage drop
- Fewer or smaller circuits
- Lower I^2R losses (thus, more energy efficient)
- Step-down transformers can be used for reregulation of voltage

Overall, the above advantages translate into a cost-effective, energy-efficient system design.

3.3 SHORT-CIRCUIT CALCULATIONS

Introduction

Several sections of the NEC relate to proper overcurrent protection. Safe and reliable application of overcurrent-protective devices based on these sections mandate that a short-circuit study and a selective-coordination study be conducted.

The protection for an electrical system should not only be safe under all service conditions but, to ensure continuity of service, it should be selectively coordinated as well. A coordinated system is one in which only the faulted circuit is isolated without disturbing any other part of the system. Overcurrent protection devices should also provide short-circuit as well as overload protection for system components, such as bus, wire, motor controllers, and so forth.

To obtain reliable, coordinated operation and assure that system components are protected from damage, it is necessary to first calculate the available fault current at various critical points in the electrical system.

Once the short-circuit levels are determined, the electrical design professional can specify proper interrupting rating requirements, selectively coordinate the system, and provide component protection.

General Comments on Short-Circuit Calculations

Short-circuit calculations should be done at all critical points in the electrical system, which would include the service entrance, panelboards, motor control centers, motor starters, transfer switches, and load centers.

Normally, short-circuit studies involve calculating a bolted three-phase fault condition. This can be characterized as all three phases “bolted” together to create a zero-impedance connection. This establishes a worst-case condition that results in maximum thermal and mechanical stress in the system. From this calculation, other types of fault conditions such as line-to-line and line-to ground can be obtained.

Sources of short-circuit current that are normally taken under consideration include utility generation, local generation, synchronous motors, and induction motors. Capacitor discharge currents can generally be neglected due to their short time duration.

Asymmetrical Components

Basically, the short-circuit current is determined by Ohm's law, except that the impedance is not constant because some reactance is included in the system. The effect of reactance in an AC system is to cause the initial current to be high and then decay toward steady-state (the Ohm's

law) value. The fault current consists of an exponentially decreasing direct-current component superimposed upon a decaying alternating current. The rate of decay of both the DC and AC components depends upon the ratio of reactance to resistance (X/R) of the circuit. The greater this ratio, the longer the current remains higher than the steady-state value, which it will eventually reach.

The total fault current is not symmetrical with respect to the time axis because of the direct-current component; hence, it is called asymmetrical current. The DC component depends on the point on the voltage wave at which the fault is initiated (see Figure 3.11).

The AC component is not constant if rotating machines are connected to the system, because the impedance of this apparatus is not constant. The rapid variation of motor and generator impedance is due to these factors:

Subtransient reactance ($X_{d''}$): Determines fault current during the first cycle, and after about six cycles, this value increases to the transient reactance. It is used for the calculation of the momentary and interrupting duties of equipment and/or system.

Transient reactance ($X_{d'}$): Determines fault current after about six cycles, and in $\frac{1}{2}$ to 2 seconds this value increases to the value of the

FIGURE 3.11 Structure of asymmetrical current wave.

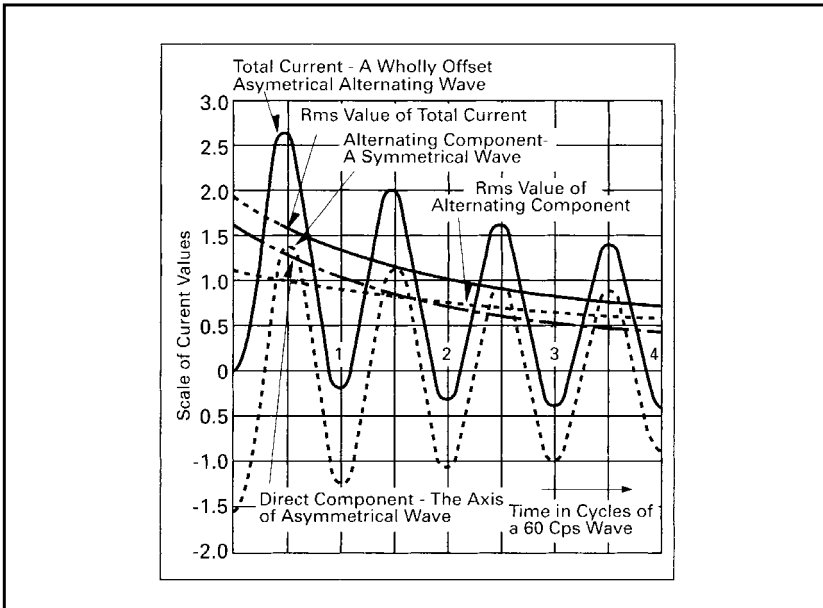

synchronous reactance. It is used in the setting of the phase over-current relays of generators.

Synchronous reactance (X_d): Determines fault current after steady-state condition is reached. It has no effect as far as short-circuit calculations are concerned, but it is useful in the determination of relay settings.

The calculation of asymmetrical currents is a laborious procedure because the degree of asymmetry is not the same on all three phases. It is common practice to calculate the root mean square (rms) symmetrical fault current, with the assumption being made that the DC component has decayed to zero, and then apply a multiplying factor to obtain the first half-cycle rms asymmetrical current, which is called the momentary current. For medium-voltage systems (defined by IEEE as greater than 1,000 V up to 69,000 V), the multiplying factor is established by NEMA and ANSI standards depending upon the operating speed of the breaker; for low-voltage systems (600 V and below), the multiplying factor is usually 1.17 (based on generally accepted use of an X/R ratio of 6.6, representing a source short-circuit power factor of 15 percent). These values take into account that medium-voltage breakers are rated on maximum asymmetry and low-voltage breakers are rated on average asymmetry.

To determine the motor contribution to the first half-cycle fault current when the system motor load is known, the following assumptions are generally made:

Induction motors: Use 4.0 times motor full-load current (impedance value of 25 percent).

Synchronous motors: Use 5.0 times motor full-load current (impedance value of 20 percent).

When the motor load is not known, the following assumptions are generally made:

208Y/120-V systems:

- Assume 50 percent lighting and 50 percent motor load.
- Assume motor feedback contribution of 2.0 times full-load current of transformer.

240-480-600-V three-phase, three-wire systems:

- Assume 100 percent motor load.
- Assume motors 25 percent synchronous and 75 percent induction.
- Assume motor feedback contribution of 4.0 times full-load current of transformer.

480Y/277-V systems in commercial buildings:

- Assume 50 percent induction motor load.
- Assume motor feedback contribution of 2.0 times full-load current of transformer or source.
- For industrial plants, make same assumptions as for three-phase, three-wire systems (above).

Medium-Voltage Motors:

- If known, use actual values. Otherwise, use the values indicated in the above for the same type of motor.

Procedures and Methods, Three-Phase Short-Circuit Calculations

Four basic methods are used to calculate short-circuit currents:

1. Ohmic method
2. Per-unit method
3. Computer software method
4. Point-to-point method

All four methods achieve essentially the same results with a reasonable degree of accuracy. The ohmic method is usually used for very simple systems. The per-unit and computer software methods are often used for more complex systems where there are many branches, buses, and critical points for fault calculations. The computer software method is by far the most popular method used today because of its speed and ability to run multiple system design condition scenarios. Computer software usually uses the per-unit method as the basis for computations.

For the purposes of this handbook, however, the point-to-point method offers a simple, effective, and quick way to determine available short-circuit levels in simple- to medium-complexity three-phase and single-phase electrical distribution systems with a reasonable degree of accuracy.

In any short-circuit calculation method, it must be understood that the calculations are performed without current-limiting devices in the system. Calculations are done as though these devices are replaced with copper bars, to determine the maximum available short-circuit current. This is necessary to project how the system and the current-limiting devices will perform.

Also, current-limiting devices do not operate in series to produce a “compounding” current-limiting effect. The downstream, or load-side, fuse/breaker will operate alone under a short-circuit condition if properly coordinated.

To start, first draw a one-line diagram showing all of the circuit components, parameters (including feeder lengths), and sources of fault current. Second, obtain the utility company–available short circuit in KVA, MVA, or SCA. With this information, the necessary calculations can be made to determine the fault current at any point in the electrical system.

The point-to-point method can best be illustrated by the following figures and table. Figure 3.12 shows the steps and equations needed in the point-to-point method. Figure 3.13 shows one-line diagrams of two systems (A and B) to be used as illustrative examples. Figures 3.14 and 3.15 show the calculations for these two examples. And, Table 3.17 provides the circuit constants needed in the equations for the point-to-point method.

How to Calculate Short-Circuit Currents at Ends of Conductors

Even the most exact methods for calculating fault energy (as in the point-to-point method) use some approximations and assumptions. Therefore, it is appropriate to select a method that is sufficiently accurate for the purpose, but not more burdensome than is justified. The following two methods make use of simplifications that are reasonable under most circumstances and will almost certainly yield answers that are on the safe side.

SHORT-CUT METHOD 1—ADDING Z_s s

This method uses the approximation of adding Z_s instead of the accurate method of R_s and X_s (in complex form). Example:

- For a 480/277-V system with 30,000 amperes symmetrical available at the line side of a conductor run of 100 ft of 2–500 kcmil per phase and neutral, the approximate fault current at the load-side end of the conductors can be calculated as follows:

$$277 \text{ V}/30,000 \text{ A} = 0.00923 \ \Omega \text{ (source impedance).}$$

- Conductor ohms for 500 kcmil conductor from Table 3.18 in magnetic conduit is 0.00546 Ω per 100 ft. For 100 ft and 2 conductors per phase we have:

$$0.00546/2 = 0.00273 \ \Omega \text{ (conductor impedance).}$$

- Add source and conductor impedance or $0.00923 + 0.00273 = 0.01196$ total ohms.
- Next, $277 \text{ V}/0.01196 \ \Omega = 23,160 \text{ A rms}$ at load side of conductors.

For impedance values, refer to Tables 3.18, 3.19, and 3.20.

FIGURE 3.12 Point-to-point method, three-phase short-circuit calculations, basic calculation procedure and formulas.

The application of the point-to-point method permits the determination of available short-circuit currents with a reasonable degree of accuracy at various points for either 3Ø or 1Ø electrical distribution systems. This method can assume unlimited primary short-circuit current (infinite bus).

Basic Point-to-Point Calculation Procedure

Step 1. Determine the transformer full load amperes from either the nameplate or the following formulas:

3Ø Transformer $I_{FL} = \frac{KVA \times 1000}{E_{L-L} \times 1.732}$

1Ø Transformer $I_{FL} = \frac{KVA \times 1000}{E_{L-L}}$

Step 2. Find the transformer multiplier.

Multiplier = $\frac{100}{\%Z_{trans}}$

Note. Transformer impedance (Z) helps to determine what the short circuit current will be at the transformer secondary. Transformer impedance is determined as follows: The transformer secondary is short circuited. Voltage is applied to the primary which causes full load current to flow in the secondary. This applied voltage divided by the rated primary voltage is the impedance of the transformer.
 Example: For a 480 volt rated primary, if 9.6 volts causes secondary full load current to flow through the shorted secondary, the transformer impedance is $9.6/480 = .02 = 2\%Z$.
 In addition, UL listed transformer 25KVA and larger have a $\pm 10\%$ impedance tolerance. Short circuit amperes can be affected by this tolerance.

Step 3. Determine the transformer let-thru short-circuit current**.

$I_{S.C.} = I_{FL} \times \text{Multiplier}$

Note. Motor short-circuit contribution, if significant, may be added to the transformer secondary short-circuit current value as determined in Step 3. Proceed with this adjusted figure through Steps 4, 5 and 6. A practical estimate of motor short-circuit contribution is to multiply the total motor current in amperes by 4.

Step 4. Calculate the "f" factor.

3Ø Faults $f = \frac{1.732 \times L \times I}{C \times E_{L-L}}$

1Ø Line-to-Line (L-L) Faults on 1Ø Center Tapped Transformer $f = \frac{2 \times L \times I}{C \times E_{L-L}}$

1Ø Line-to-Neutral (L-N) Faults on 1Ø Center Tapped Transformer $f = \frac{2 \times L \times I^2}{C \times E_{L-N}}$

Where:
 L = length (feet) of circuit to the fault.
 C = constant from Table 6, page 27. For parallel runs, multiply C values by the number of conductors per phase.
 I = available short-circuit current in amperes at beginning of circuit.

Note. The L-N fault current is higher than the L-L fault current at the secondary terminals of a single-phase center-tapped transformer. The short-circuit current available (I) for this case in Step 4 should be adjusted at L-N center tapped transformer terminals.
I = 1.5 x L-L Short-Circuit Amperes at Transformer Terminals

At some distance from the terminals, depending upon wire size, the L-N fault current is lower than the L-L fault current. The 1.5 multiplier is an approximation and will theoretically vary from 1.33 to 1.67. These figures are based on change in turns ratio between primary and secondary, infinite source available, zero feet from terminals of transformer, and $1.2 \times \%X$ and $1.5 \times \%R$ for L-N vs. L-L resistance and reactance values. Begin L-N calculations at transformer secondary terminals, then proceed point-to-point.

Step 5. Calculate "M" (multiplier).

$M = \frac{1}{1+f}$

Step 6. Calculate the available short-circuit symmetrical RMS current at the point of fault.

$I_{S.C. \text{ sym RMS}} = I_{S.C.} \times M$

Calculation of Short-Circuit Currents at Second Transformer in System

Use the following procedure to calculate the level of fault current at the secondary of a second, downstream transformer in a system when the level of fault current at the transformer primary is known.

Procedure for Second Transformer in System

Step 1. Calculate the "f" factor ($I_{S.C. \text{ primary}}$ known)

3Ø Transformer ($I_{S.C. \text{ primary}}$ and $I_{S.C. \text{ secondary}}$ are 3Ø fault values)
 $f = \frac{I_{S.C. \text{ primary}} \times V_{\text{primary}} \times 1.73 (\%Z)}{100,000 \times KVA_{\text{trans}}}$

1Ø Transformer ($I_{S.C. \text{ primary}}$ and $I_{S.C. \text{ secondary}}$ are 1Ø fault values; $I_{S.C. \text{ secondary}}$ is L-L)
 $f = \frac{I_{S.C. \text{ primary}} \times V_{\text{primary}} \times (\%Z)}{100,000 \times KVA_{\text{trans}}}$

Step 2. Calculate "M" (multiplier).

$M = \frac{1}{1+f}$

Step 3. Calculate the short-circuit current at the secondary of the transformer. (See Note under Step 3 of "Basic Point-to-Point Calculation Procedure".)

$I_{S.C. \text{ secondary}} = \frac{V_{\text{primary}}}{V_{\text{secondary}}} \times M \times I_{S.C. \text{ primary}}$

FIGURE 3.13 System A and system B circuit diagrams for sample calculations using point-to-point method.

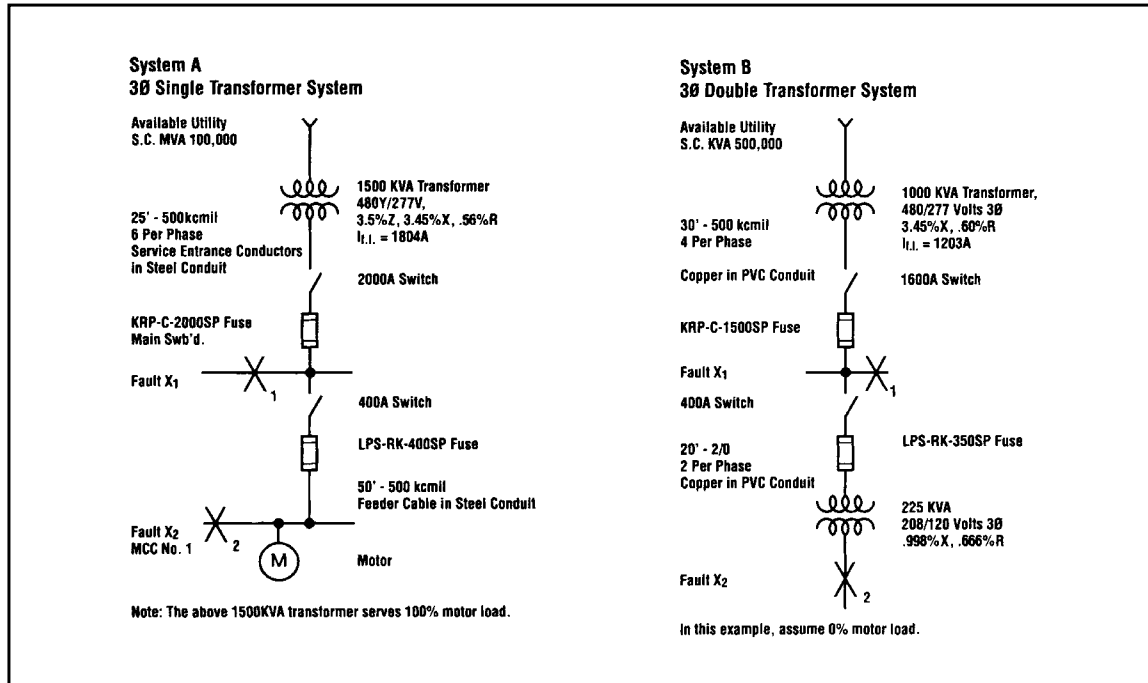

FIGURE 3.14 Point-to-point calculations for system A, to faults X₁ and X₂.

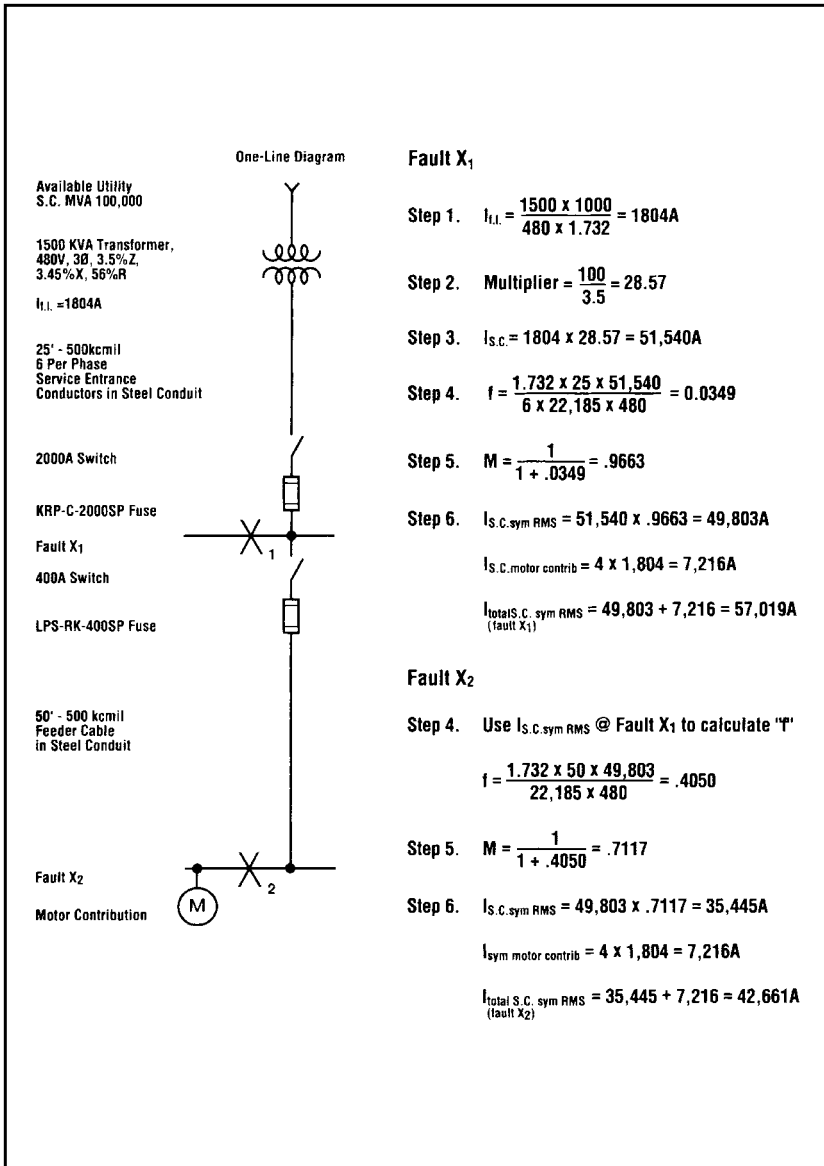

FIGURE 3.15 Point-to-point calculations for system B, to faults X_1 and X_2 .

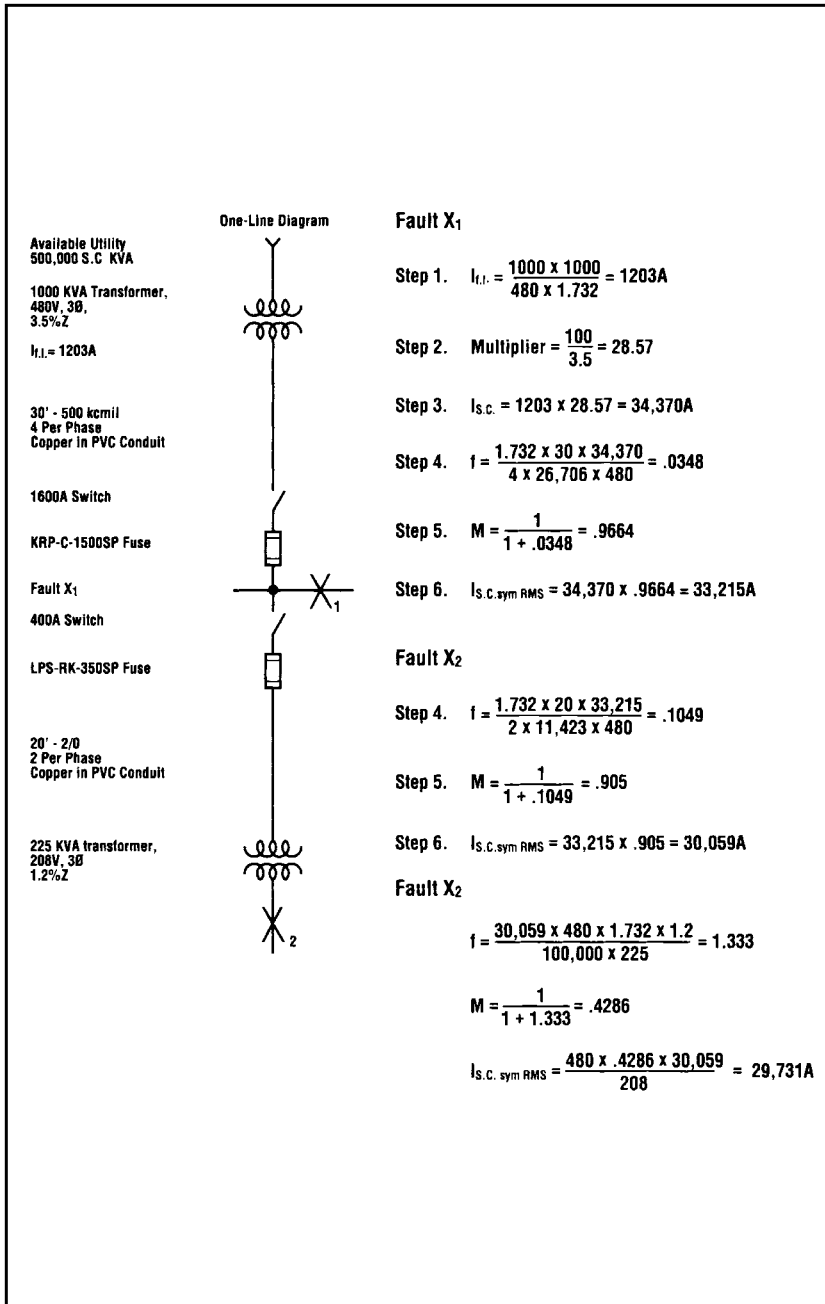

TABLE 3.17 "C" Values for Conductors and Busway

Copper AWG or kcmil	Three-Conductor Cable													
	Three Single Conductors or Conduit Steel					Conduit Steel								
	Nonmagnetic		Nonmagnetic		Nonmagnetic		Nonmagnetic		Nonmagnetic					
600V	5KV	15KV	600V	5KV	15KV	600V	5KV	15KV	600V	5KV	15KV	600V	5KV	15KV
14	389	389	389	389	389	389	389	389	389	389	389	389	389	389
12	617	617	617	617	617	617	617	617	617	617	617	617	617	617
10	981	981	981	981	981	981	981	981	981	981	981	981	981	981
8	1557	1551	1557	1558	1555	1558	1559	1557	1557	1559	1559	1559	1558	1559
6	2425	2406	2389	2430	2417	2406	2431	2424	2424	2414	2433	2433	2428	2420
4	3806	3750	3695	3825	3789	3752	3830	3811	3778	3778	3837	3837	3823	3798
3	4760	4760	4760	4802	4802	4802	4760	4790	4760	4760	4802	4802	4802	4802
2	5906	5736	5574	6044	5926	5809	5989	5929	5827	5827	6087	6087	6022	5957
1	7292	7029	6758	7493	7306	7108	7454	7364	7188	7188	7579	7579	7507	7364
1/0	8924	8543	7973	9317	9033	8590	9209	9086	8707	8707	9472	9472	9372	9052
2/0	10755	10061	9389	11423	10877	10318	11244	11045	10500	10500	11703	11703	11528	11052
3/0	12843	11804	11021	13923	13048	12360	13656	13333	12613	12613	14410	14410	14118	13461
4/0	15082	13605	12542	16673	15351	14347	16391	15890	14813	14813	17482	17482	17019	16012
250	16483	14924	13643	18593	17120	15865	18310	17850	16465	16465	19779	19779	19352	18001
300	18176	16292	14768	20867	18975	17408	20617	20051	18318	18318	22524	22524	21938	20163
350	19703	17385	15678	22736	20526	18672	19557	21914	19821	19821	22736	22736	24126	21982
400	20565	18235	16365	24296	21786	19731	24253	23371	21042	21042	26915	26915	26044	23517
500	22185	19172	17492	26706	23277	21329	26980	25449	23125	23125	30028	30028	28712	25916
600	22965	20567	47962	28033	25203	22097	28752	27974	24896	24896	32236	32236	31258	27766
750	24136	21386	18888	28303	25430	22690	31050	30024	26932	26932	32404	32404	31338	28303
1000	25278	22539	19923	31490	28083	24887	33864	32688	29320	29320	37197	37197	35748	31959

TABLE 3.17 "C" Values for Conductors and Busway (Continued)

Aluminum												
14	236	236	236	236	236	236	236	236	236	236	236	236
12	375	375	375	375	375	375	375	375	375	375	375	375
10	598	598	598	598	598	598	598	598	598	598	598	598
8	951	950	951	950	951	951	951	951	951	951	951	951
6	1480	1476	1472	1481	1478	1476	1481	1480	1478	1482	1481	1479
4	2345	2332	2319	2350	2341	2333	2351	2347	2339	2353	2349	2344
3	2948	2948	2948	2958	2958	2958	2948	2956	2948	2958	2958	2958
2	3713	3669	3626	3729	3701	3672	3733	3719	3693	3739	3724	3709
1	4645	4574	4497	4678	4631	4580	4686	4663	4617	4699	4681	4646
1/0	5777	5669	5493	5838	5766	5645	5852	5820	5717	5875	5851	5771
2/0	7186	6968	6733	7301	7152	6986	7327	7271	7109	7372	7328	7201
3/0	8826	8466	8163	9110	8851	8627	9077	8980	8750	9242	9164	8977
4/0	10740	10167	9700	11174	10749	10386	11184	11021	10642	11408	11277	10968
250	12122	11460	10848	12862	12343	11847	12796	12636	12115	13236	13105	12661
300	13909	13009	12192	14922	14182	13491	14916	14698	13973	15494	15299	14658
350	15484	14280	13288	16812	15857	14954	15413	16490	15540	16812	17351	16500
400	16670	15355	14188	18505	17321	16233	18461	18063	16921	19587	19243	18154
500	18755	16827	15657	21390	19503	18314	21394	20606	19314	22987	22381	20978
600	20093	18427	16484	23451	21718	19635	23633	23195	21348	25750	25243	23294
750	21766	19685	17686	23491	21769	19976	26431	25789	23750	25682	25141	23491
1000	23477	21235	19005	28778	26109	23482	29864	29049	26608	32938	31919	29135

TABLE 3.17 “C” Values for Conductors and Busway (*Continued*)

Ampacity	Busway				
	Plug-In	Feeder		High Impedance	
	Copper	Aluminum	Copper	Aluminum	Copper
225	28700	23000	18700	12000	—
400	38900	34700	23900	21300	—
600	41000	38300	36500	31300	—
800	46100	57500	49300	44100	—
1000	69400	89300	62900	56200	15600
1200	94300	97100	76900	69900	16100
1350	119000	104200	90100	84000	17500
1600	129900	120500	101000	90900	19200
2000	142900	135100	134200	125000	20400
2500	143800	156300	180500	166700	21700
3000	144900	175400	204100	188700	23800
4000	—	—	277800	256400	—

SHORT-CUT METHOD 2—CHART APPROXIMATE METHOD

The chart method is based on the following:

Motor Contribution Assumptions

120/208-V systems	50 percent motor load
	4 times motor FLA contribution
240- and 480-V systems	100 percent motor load
	4 times motor FLA contribution

Feeder Conductors

The conductor sizes most commonly used for feeders from molded case circuit breakers are shown. For conductor sizes not shown, the following table has been included for conversion to equivalent arrangements. In some cases, it may be necessary to interpolate for unusual feeder ratings. Table 3.21 is based on using copper conductor.

Short-Circuit Current Readout

The readout obtained from the charts is the rms symmetrical amperes available at the given distance from the transformer. The circuit breaker should have an interrupting capacity at least as large as this value.

HOW TO USE THE SHORT-CIRCUIT CHARTS

Step 1: Obtain the following data:

- System voltage
- Transformer kVA rating
- Transformer impedance
- Primary source fault energy available in KVA

TABLE 3.18 Average Characteristics of 600-Volt Conductors (Ohms per 100 ft)—Two or Three Single Conductors

Wire Size, AWG or kcmil	Copper Conductors						Aluminum Conductors					
	Magnetic Conduit			Nonmagnetic Conduit			Magnetic Conduit			Nonmagnetic Conduit		
	R	X	Z	R	X	Z	R	X	Z	R	X	Z
14	.3130	.00780	.3131	.3130	.00624	.3131	-	-	-	-	-	-
12	.1968	.00730	.1969	.1968	.00584	.1969	-	-	-	-	-	-
10	.1230	.00705	.1232	.1230	.00564	.1231	-	-	-	-	-	-
8	.0789	.00691	.0792	.0789	.00553	.0791	-	-	-	-	-	-
6	.0490	.00640	.0494	.0490	.00512	.0493	.0833	.00509	.0835	.0833	.00407	.0834
4	.0318	.00591	.0323	.0318	.00473	.0321	.0530	.00490	.0532	.0530	.00392	.0531
2	.0203	.00548	.0210	.0203	.00438	.0208	.0335	.00457	.0338	.0335	.00366	.0337
1	.0162	.00533	.0171	.0162	.00426	.0168	.0267	.00440	.0271	.0267	.00352	.0269
1/0	.0130	.00519	.01340	.0129	.00415	.01360	.0212	.00410	.0216	.0212	.00328	.0215
2/0	.0104	.00511	.01159	.0103	.00409	.01108	.0170	.00396	.0175	.0170	.00317	.0173
3/0	.00843	.00502	.00981	.00803	.00402	.00898	.01380	.00386	.0143	.01380	.00309	.01414
4/0	.00696	.00489	.00851	.00666	.00391	.00772	.01103	.00381	.0117	.01097	.00305	.01139
250	.00588	.00487	.00763	.00578	.00390	.00697	.00936	.00375	.01008	.00933	.00300	.00980
300	.00512	.00484	.00705	.00501	.00387	.00633	.00810	.00366	.00899	.00797	.00293	.00849
350	.00391	.00480	.00619	.00380	.00384	.00540	.00694	.00360	.00782	.00688	.00288	.00746
400	.00369	.00476	.00602	.00356	.00381	.00521	.00618	.00355	.00713	.00610	.00284	.00673
450	.00330	.00467	.00595	.00310	.00374	.00486	.00548	.00350	.00650	.00536	.00280	.00605
500	.00297	.00458	.00546	.00275	.00366	.00458	.00482	.00346	.00593	.00470	.00277	.00546
600	.00261	.00455	.00525	.00241	.00364	.00437	.00409	.00355	.00542	.00395	.00284	.00486
700	.00247	.00448	.00512	.00247	.00358	.00435	.00346	.00340	.00485	.00330	.00272	.00428
750	.00220	.00441	.00493	.00198	.00353	.00405	.00308	.00331	.00452	.00278	.00265	.00384
1000	-	-	-	-	-	-	.00250	.00330	.00414	.00230	.00264	.00350

194



TABLE 3.19 Average Characteristics of 600-Volt Conductors (Ohms per 100 ft)—Three Conductor Cables (and Interlocked Armored Cable)

Wire Size, AWG or kcmil	Copper Conductors						Aluminum Conductors					
	Magnetic Conduit			Nonmagnetic Conduit			Magnetic Conduit			Nonmagnetic Conduit		
	R	X	Z	R	X	Z	R	X	Z	R	X	Z
14	.3130	.00597	.3131	.3130	.00521	.3130	—	—	—	—	—	—
12	.1968	.00558	.1969	.1968	.00487	.1969	—	—	—	—	—	—
10	.1230	.00539	.1231	.1230	.00470	.1231	—	—	—	—	—	—
8	.0789	.00529	.0790	.0789	.00461	.0790	—	—	—	—	—	—
6	.0490	.00491	.0492	.0490	.00427	.0492	.0833	.00509	.0834	.0833	.00407	.0834
4	.0318	.00452	.0321	.0318	.00394	.0320	.0530	.00490	.0532	.0530	.00392	.0531
2	.0203	.00420	.0207	.0203	.00366	.0206	.0335	.00457	.0338	.0335	.00366	.0337
1	.0162	.00408	.0167	.0162	.00355	.0166	.0267	.00440	.0271	.0267	.00352	.0269
1/0	.0130	.00398	.0136	.0129	.00346	.0134	.0212	.00410	.0216	.0212	.00328	.0215
2/0	.0104	.00390	.0111	.0103	.00341	.0108	.0170	.00396	.0175	.0170	.00317	.0173
3/0	.00843	.00384	.00926	.00803	.00335	.00870	.01380	.00389	.0143	.01380	.00309	.01414
4/0	.00696	.00375	.00791	.00666	.00326	.00742	.01103	.00381	.0117	.01097	.00305	.01139
250	.00588	.00373	.00696	.00578	.00325	.00663	.00936	.00375	.01006	.00933	.00300	.00980
300	.00512	.00370	.00632	.00501	.00323	.00596	.00810	.00366	.00889	.00797	.00293	.00849
350	.00391	.00365	.00535	.00380	.00320	.00497	.00694	.00360	.00782	.00688	.00288	.00746
400	.00369	.00360	.00516	.00356	.00318	.00477	.00618	.00355	.00713	.00610	.00284	.00673
450	.00360	.00351	.00503	.00310	.00312	.00440	.00548	.00350	.00650	.00536	.00280	.00605
500	.00297	.00343	.00454	.00275	.00305	.00411	.00482	.00346	.00593	.00470	.00277	.00546
600	.00261	.00337	.00426	.00241	.00303	.00387	.00409	.00355	.00542	.00395	.00284	.00486
700	.00247	.00330	.00412	.00227	.00298	.00375	.00346	.00341	.00486	.00330	.00272	.00428
750	.00220	.00323	.00391	.00198	.00294	.00354	.00308	.00331	.00452	.00278	.00265	.00384
1000	—	—	—	—	—	—	.00250	.00330	.00414	.00230	.00264	.00350

① Resistance and reactance are phase-to-neutral values, based on 60 Hertz ac, 3-phase, 4-wire distribution, in ohms per 100 feet of circuit length (not total conductor lengths).

② Based upon conductivity of 100% for copper, 61% for aluminum.

③ Based on conductor temperatures of 75°C. Reactance values will have negligible variation with temperature. Resistance of both copper and aluminum conductors will be approximately 5% lower at 60°C or 5% higher at 90°C. Data shown in tables may be used without significant error between 60°C and 90°C.

④ For interlocked armored cable, use magnetic conduit data for steel armor and non-magnetic conduit data for aluminum armor.

$$⑤ = \sqrt{X^2 + R}$$

⑥ For busway impedance data, see page 477.



TABLE 3.20 LV Busway, R, X, and Z (Ohms per 100 ft)

Ampere Rating	Plug-in			Feeder		
	Resistance	Reactance	Impedance	Resistance	Reactance	Impedance
Aluminum						
225	.00737	.00323	.00805	.00737	.00323	.00805
400	.00371	.00280	.00465	.00371	.00280	.00465
600	.00291	.00212	.00360	.00289	.00127	.00316
800	.00248	.00114	.00273	.00244	.000660	.00253
1000	.00188	.00100	.00213	.00197	.000552	.00205
1200	.00155	.000755	.00172	.00159	.000490	.00166
1350	.00130	.000600	.00143	.00134	.000385	.00139
1600	.00106	.000480	.00116	.00112	.000350	.00117
2000	.000841	.000449	.000953	.000864	.000310	.000918
2500	.000648	.000290	.000710	.000664	.000250	.000710
3000	.000521	.000183	.000552	.000558	.000197	.000592
4000	.000397	.000175	.000434	.000409	.000135	.000431
Copper						
225	.00425	.00323	.00534	.00425	.00323	.00534
400	.00291	.00301	.00419	.00291	.00301	.00419
600	.00212	.00234	.00316	.00202	.00170	.00264
800	.00169	.00212	.00271	.00188	.00149	.00240
1000	.00144	.00114	.00184	.00158	.000965	.00185
1200	.00112	.00100	.00150	.00120	.000552	.00132
1350	.00101	.000960	.00139	.00108	.000510	.00119
1600	.000898	.000716	.00115	.000920	.000480	.00104
2000	.000667	.000562	.000872	.000724	.000434	.000844
2500	.000494	.000449	.000668	.000520	.000305	.000603
3000	.000465	.000355	.000585	.000488	.000290	.000568
4000	.000336	.000242	.000414	.000378	.000203	.000429
5000000264	.000139	.000298

TABLE 3.21 Conductor Conversion (Based on Using Copper Conductor)

If Your Conductor is:	Use Equivalent Arrangement
3 – No. 4/0 cables	2 – 500 MCM
4 – No. 2/0 cables	2 – 500 MCM
3 – 2000 MCM cables	4 – 750 MCM
5 – 400 MCM cables	4 – 750 MCM
6 – 300 MCM cables	4 – 750 MCM
800 Amp busway	2 – 500 MCM
1000 Amp busway	2 – 500 MCM
1600 Amp busway	4 – 750 MCM

- Step 2:* Select the applicable chart from Figure 3.16 (Charts 1–13). The charts are grouped by secondary system voltage, which is listed with each transformer. Within each group, the chart for the lowest kVA transformer is shown first, followed in ascending order to the highest-rated transformer.
- Step 3:* Select the family of curves that is closest to the “available source kVA.” The upper-value line family of curves is for a source of 500,000 kVA. The lower-value line family of curves is for a source of 50,000 kVA. You may interpolate between curves if necessary, but for values above 100,000 kVA, it is appropriate to use the 500,000 kVA curves.
- Step 4:* Select the specific curve for the conductor size being used. If your conductor size is something other than the sizes shown on the chart, refer to the conductor conversion Table 3.21.
- Step 5:* Enter the chart along the bottom horizontal scale with the distance (in feet) from the transformer to the fault point. Draw a vertical line up the chart to the point at which it intersects the

FIGURE 3.16 Charts 1 through 13 for calculating short-circuit currents using chart approximate method.

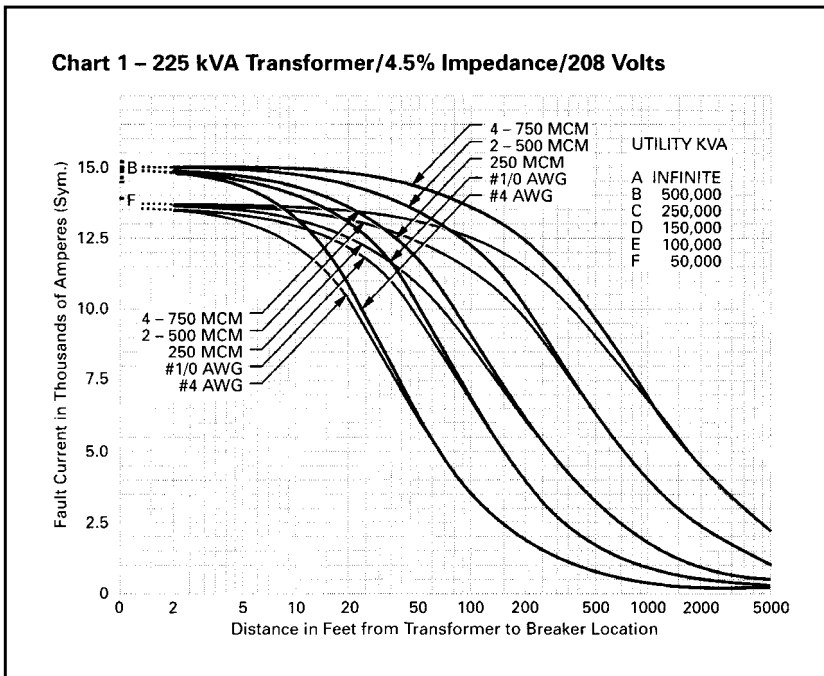

FIGURE 3.16 Charts 1 through 13 for calculating short-circuit currents using chart approximate method. (Continued)

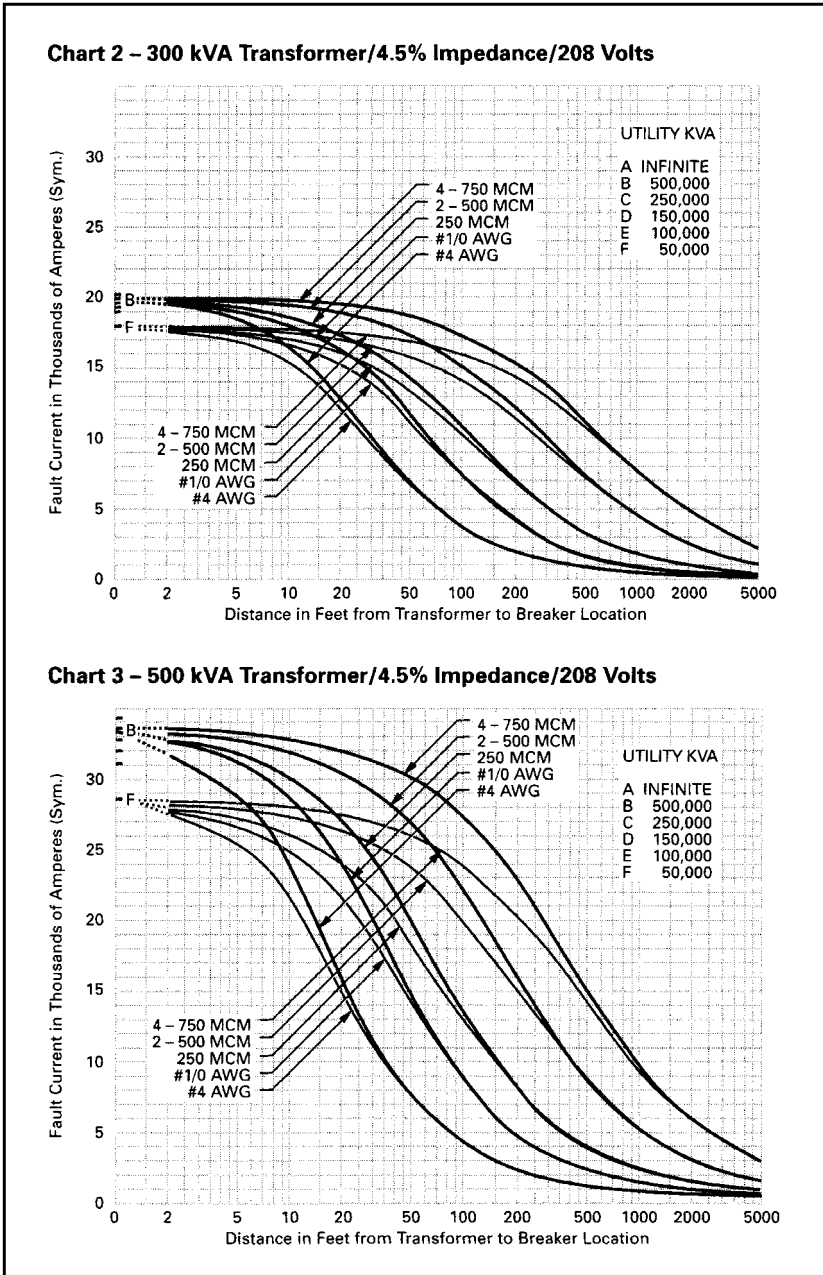

FIGURE 3.16 Charts 1 through 13 for calculating short-circuit currents using chart approximate method. (Continued)

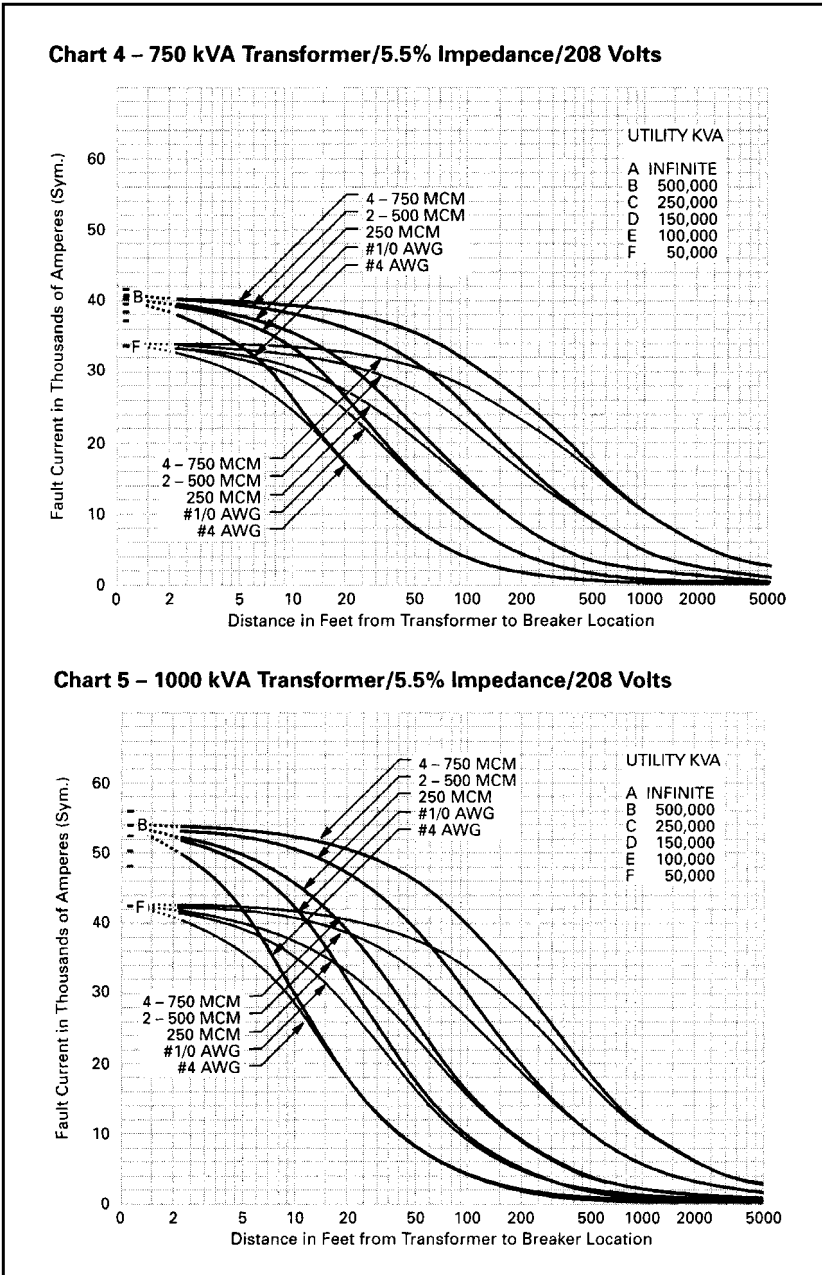

FIGURE 3.16 Charts 1 through 13 for calculating short-circuit currents using chart approximate method. (Continued)

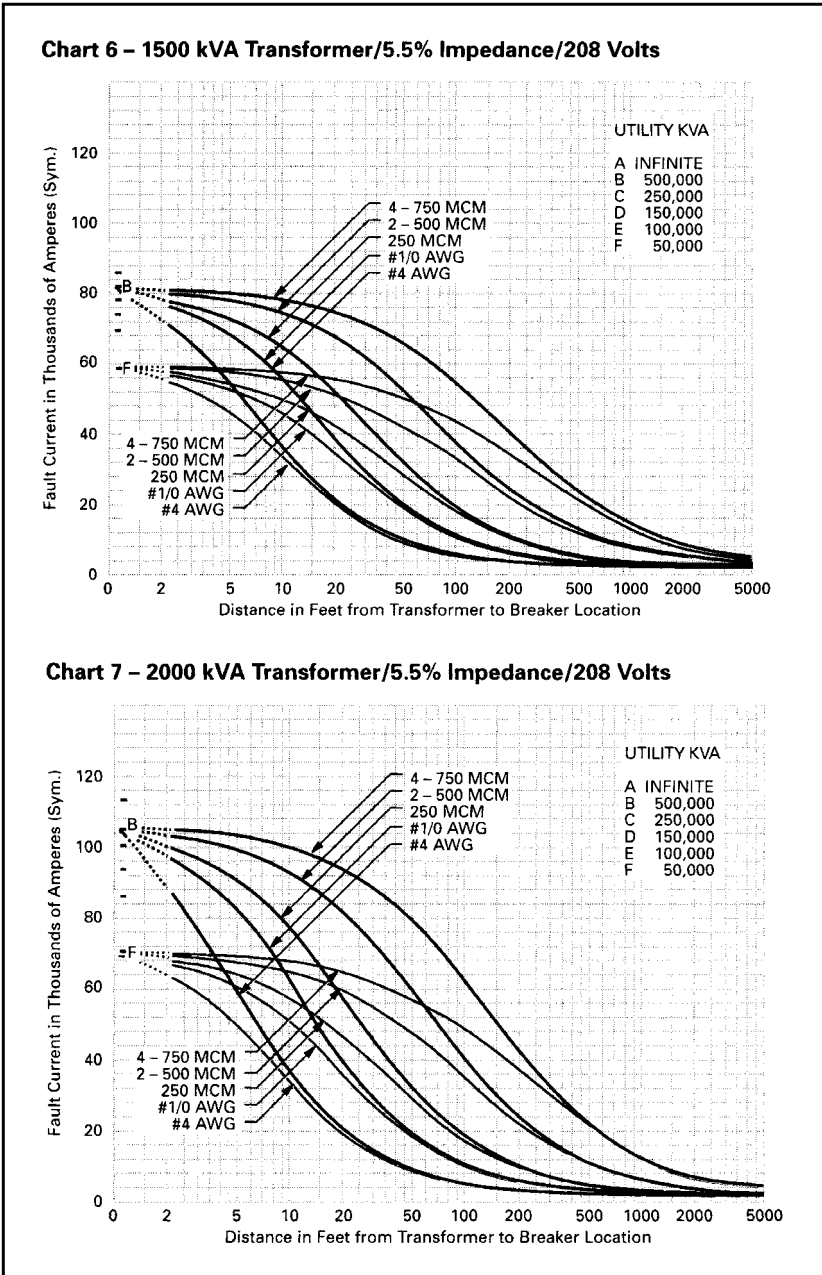

FIGURE 3.16 Charts 1 through 13 for calculating short-circuit currents using chart approximate method. (Continued)

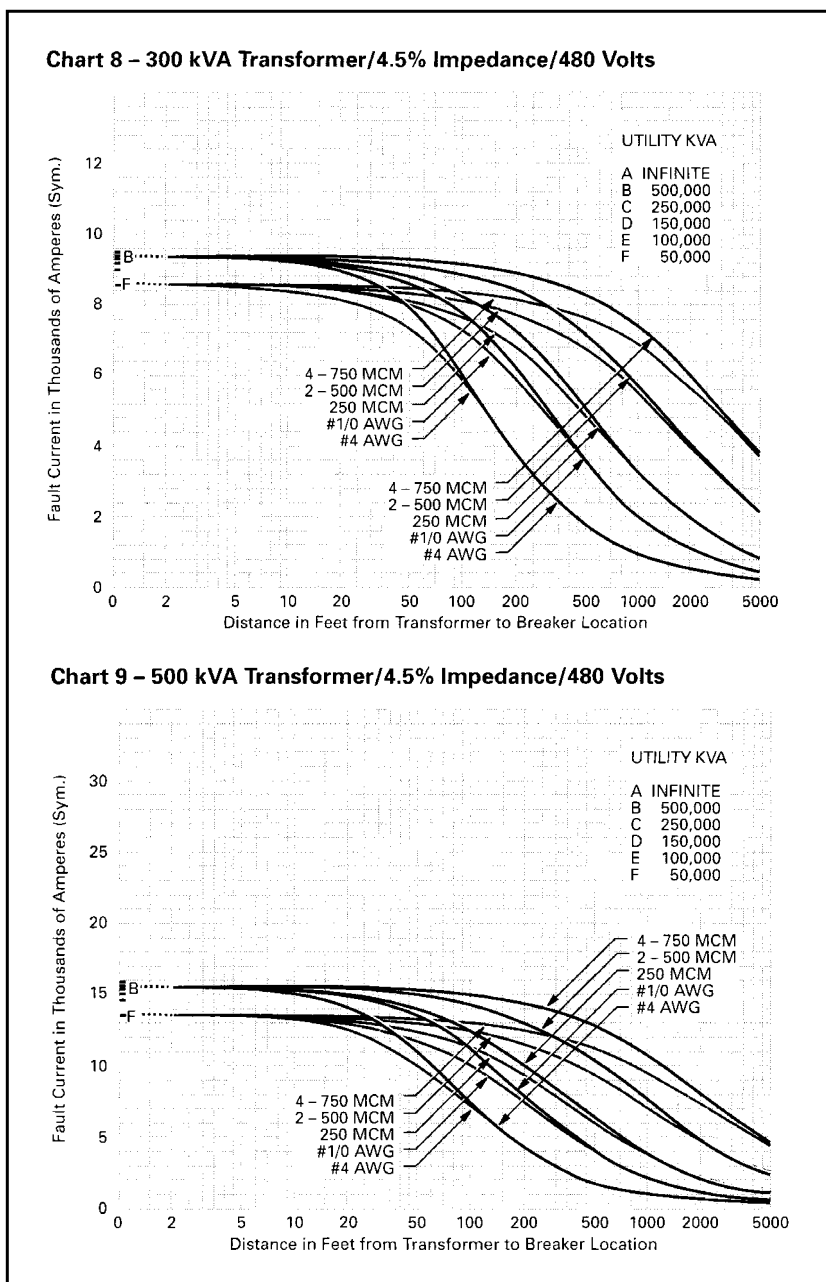

FIGURE 3.16 Charts 1 through 13 for calculating short-circuit currents using chart approximate method. (Continued)

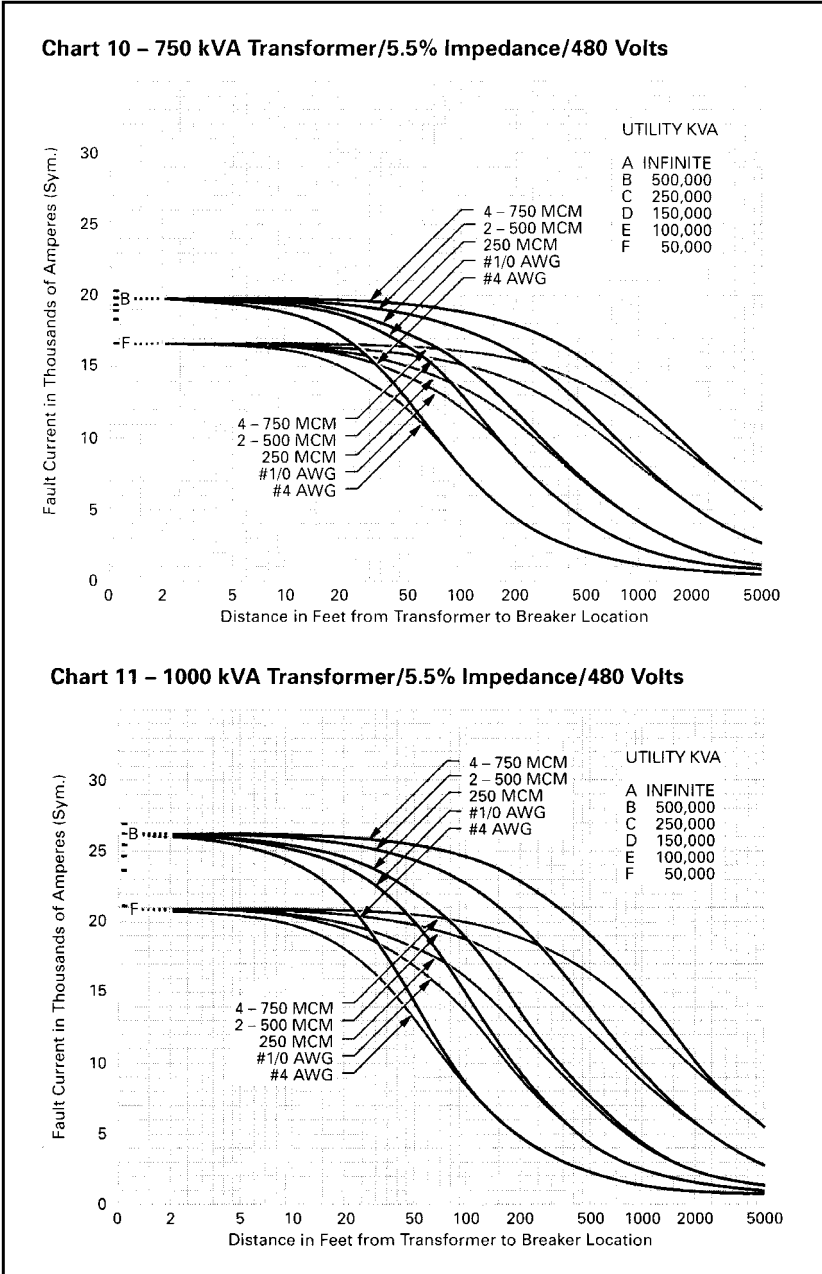
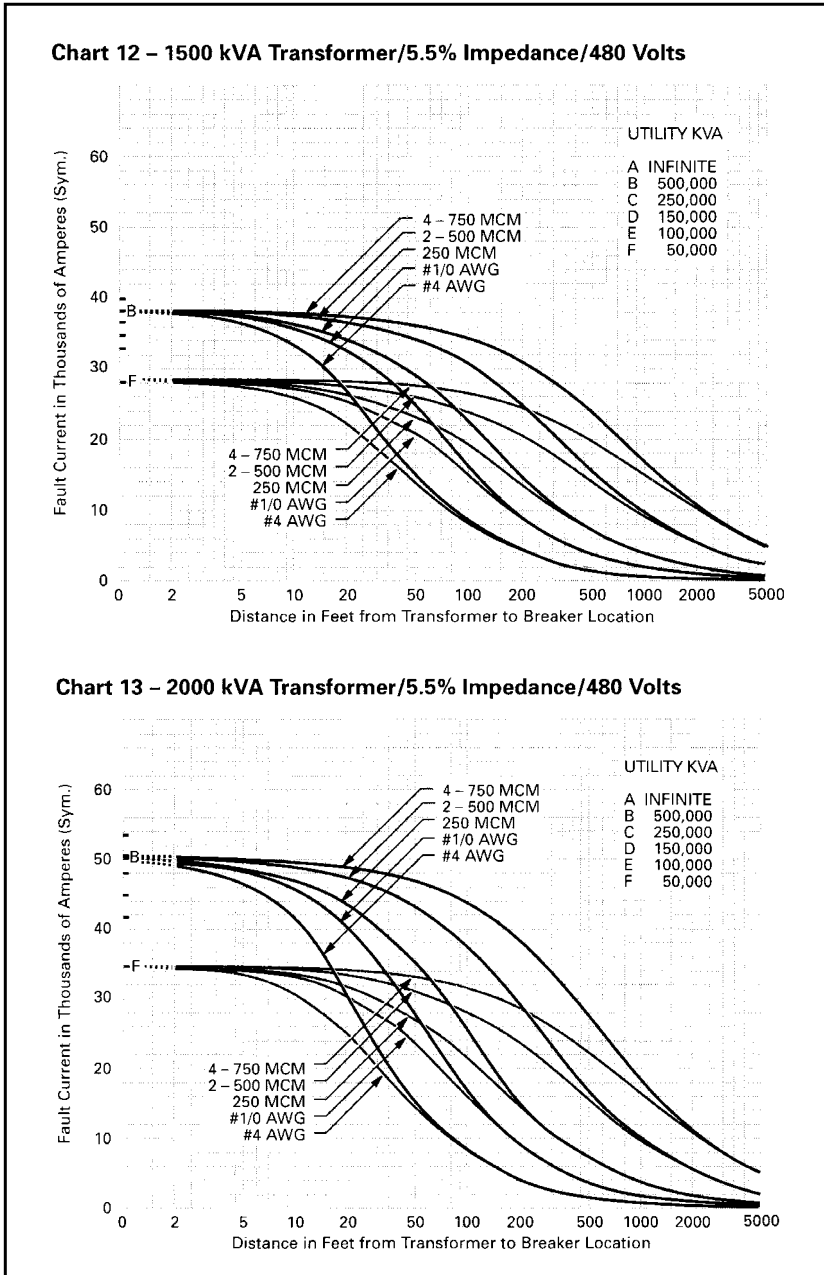

FIGURE 3.16 Charts 1 through 13 for calculating short-circuit currents using chart approximate method. (Continued)



selected curve. Then draw a horizontal line to the left from this point to the scale along the left side of the chart.

Step 6: The value obtained from the left-hand vertical scale is the fault current (in thousands of amperes) available at the fault point.

Table 3.22 shows secondary short-circuit capacity of typical power transformers.

3.4 SELECTIVE COORDINATION OF OVERCURRENT-PROTECTIVE DEVICES

Introduction

It is not enough to select protective devices based solely on their ability to carry the system load current and interrupt the maximum fault current at their respective levels. A properly engineered system will allow *only* the protective device nearest the fault to open, leaving the remainder of the system undisturbed and preserving continuity of service.

We may then define selective coordination as *the act of isolating a faulted circuit from the remainder of the electrical system, thereby eliminating unnecessary power outages. The faulted circuit is isolated by the selective operation of only that overcurrent-protective device closest to the overcurrent condition.*

Popular Methods of Performing a Selective Coordination Study

Currently, two methods are most often used to perform a coordination study:

- Overlays of time-current curves, which use a light table and manufacturers' published data, then hand-plot on log-log paper.
- Computer programs, which use a PC and allow the designer to select time-current curves published by the manufacturers and transfer to a plotter or printer, following proper selections.

This text will apply to both methods.

Recommended Procedures

The following steps are recommended when conducting a selective coordination study.

1. *One-line diagram:* Obtain or develop the electrical system one-line diagram that identifies important system components, as given hereafter.

TABLE 3.22 Secondary Short-Circuit Capacity of Typical Power Transformers

Trans-Former Rating 3-Phase kVA and Impedance Percent	Maximum Short Circuit kVA Available From Primary System	208 Volts, 3-Phase				240 Volts, 3-Phase				480 Volts, 3-Phase				600 Volts, 3-Phase							
		Rated Load Continuous Current, Amps	Short-Circuit Current RMS Symmetrical Amps			Rated Load Continuous Current, Amps	Short-Circuit Current RMS Symmetrical Amps			Rated Load Continuous Current, Amps	Short-Circuit Current RMS Symmetrical Amps			Rated Load Continuous Current, Amps	Short-Circuit Current RMS Symmetrical Amps						
			Trans-former Alone ①	50% Motor Load ②	Com-bined		Trans-former Alone ①	100% Motor Load ②	Com-bined		Trans-former Alone ②	100% Motor Load ①	Com-bined		Trans-former Alone ②	100% Motor Load ①	Com-bined				
300 5%	50000	834	14900	1700	16600	722	12900	2900	15800	361	6400	1400	7800	289	5200	1200	6400				
	100000		15700				17400				13600				16500			6800	8200	5500	6700
	150000		16000				17700				13900				16800			6900	8300	5600	6800
	250000		16300				18000				14100				17000			7000	8400	5600	6800
	500000		16500				18200				14300				17200			7100	8500	5700	6900
Unlimited	16700	18400	14400	17300	7200	8600	5800	7000													
500 5%	50000	1388	21300	2800	25900	1203	20000	4800	24800	601	10000	2400	12400	481	8000	1900	9900				
	100000		25200				28000				21900				26700			10900	13300	8700	10600
	150000		26000				28800				22500				27300			11300	13700	9000	10900
	250000		26700				29500				23100				27900			11600	14000	9300	11200
	500000		27200				30000				23600				28400			11800	14200	9400	11300
Unlimited	27800	30600	24100	28900	12000	14400	9600	11500													
750 5.75%	50000	2080	28700	4200	32900	1804	24900	7200	32100	902	12400	3600	16000	722	10000	2900	12900				
	100000		32000				36200				27800				35000			13900	17500	11100	14000
	150000		33300				37500				28900				36100			14400	18000	11600	14500
	250000		34400				38600				29800				37000			14900	18500	11900	14800
	500000		35200				39400				30600				37800			15300	18900	12200	15100
Unlimited	36200	40400	31400	38600	15700	19300	12600	15500													
1000 5.75%	50000	2776	35900	5600	41500	2406	31000	9600	40600	1203	15500	4800	20300	962	12400	3900	16300				
	100000		41200				46800				35600				45200			17800	22600	14300	18200
	150000		43300				48900				37500				47100			18700	23500	15000	18900
	250000		45200				50800				39100				48700			19600	24400	15600	19500
	500000		46700				52300				40400				50000			20200	25000	16200	20100
Unlimited	48300	53900	41800	51400	20900	25700	16700	20600													

TABLE 3.22 Secondary Short-Circuit Capacity of Typical Power Transformers (*Continued*)

Trans-Former Rating 3-Phase kVA and Impedance Percent	Maximum Short Circuit kVA Available From Primary System	208 Volts, 3-Phase				240 Volts, 3-Phase				480 Volts, 3-Phase				600 Volts, 3-Phase			
		Rated Load Continuous Current, Amps	Short-Circuit Current RMS Symmetrical Amps			Rated Load Continuous Current, Amps	Short-Circuit Current RMS Symmetrical Amps			Rated Load Continuous Current, Amps	Short-Circuit Current RMS Symmetrical Amps			Rated Load Continuous Current, Amps	Short-Circuit Current RMS Symmetrical Amps		
			Transformer Alone ①	50% Motor Load ②	Com-bined		Transformer Alone ①	100% Motor Load ②	Com-bined		Transformer Alone ②	100% Motor Load ①	Com-bined		Transformer Alone ②	100% Motor Load ①	Com-bined
1500 5.75%	50000 100000 150000 250000 500000 Unlimited	4164	47600 57500 61800 65600 68800 72500	8300	55900 65800 70100 73900 77100 80800	3609	41200 49800 53500 56800 59600 62800	14400	55600 64200 57900 71200 74000 77200	1804	20600 24900 26700 28400 29800 31400	7200	27800 32100 33900 35600 37000 38600	1444	16500 20000 21400 22700 23900 25100	5800	22300 25800 27200 28500 29700 30900
2000 5.75%	50000 100000 150000 250000 500000 Unlimited									2406	24700 31000 34000 36700 39100 41800	9600	34300 40600 43600 46300 48700 51400	1924	19700 24800 27200 29400 31300 33500	7800	27500 32600 35000 37200 39100 41300
2500 5.75%	50000 100000 150000 250000 500000 Unlimited									3008	28000 36500 40500 44600 48100 52300	12000	40000 48500 52500 56600 60100 64300	2405	22400 29200 32400 35600 38500 41800	9600	32000 38800 42000 45200 48100 51400

① Short-circuit capacity values shown correspond to kVA and impedances shown in this table. For impedances other than these, short-circuit currents are inversely proportional to impedance.

② The motor's short-circuit current contributions are computed on the basis of motor characteristics that will give four times normal current. For 208 volts, 50% motor load is assumed while for

other voltages 100% motor load is assumed. For other percentages, the motor short-circuit current will be in direct proportion.

- a. *Transformers*: Obtain the following data for protection and coordination information of transformers:
- kVA rating
 - Inrush points
 - Primary and secondary connections
 - Impedance
 - Damage curves
 - Primary and secondary voltages
 - Liquid or dry type

- b. *Conductors*: Check phase, neutral, and equipment grounding. The one-line diagram should include information such as:
- Conductor size
 - Number of conductors per phase
 - Material (copper or aluminum)
 - Insulation
 - Conduit (magnetic or nonmagnetic)

From this information, short-circuit withstand curves can be developed. This provides information on how overcurrent devices will protect conductors from overload *and* short-circuit damage.

- c. *Motors*: The system one-line diagram should include motor information such as:
- Full-load currents
 - Horsepower
 - Voltage
 - Type of starting characteristic (e.g., across the line)
 - Type of overload relay (Class 10, 20, 30)

Overload protection of the motor and motor circuit can be determined from this data.

- d. *Fuse characteristics*: Fuse types/classes should be identified on the one-line diagram.
- e. *Circuit breaker characteristics*: Circuit breaker types should be identified on the one-line diagram.
- f. *Relay characteristics*: Relay types should be identified on the one-line diagram.

2. *Short-circuit study*: Perform a short-circuit analysis, calculating maximum available short-circuit currents at critical points in the distribution system (such as transformers, main switchgear, panelboards, motor control centers, load centers, and large motors and generators). Refer to the previous section.

3. *Helpful hints*:

- a. *Determine the ampere scale selection*: It is most convenient to place the time-current curves in the center of the log-log paper.

This is accomplished by multiplying or dividing the ampere scale by a factor of 10.

- b. *Determine the reference (base) voltage:* The best reference voltage is the voltage level at which most of the devices being studied fall. On most low-voltage industrial and commercial studies, the reference voltage will be 208, 240, or 480 V. Devices at other voltage levels will be shifted by a multiplier based on the transformer turn ratio. The best reference voltage will require the least amount of manipulation. Most computer programs will automatically make these adjustments when the voltage levels of the devices are identified by the input data.
- c. *Commencing the analysis:* The starting point can be determined by the designer. Typically, studies begin with the main circuit devices and work down through the feeders and branches. (Right to left on your log-log paper.)
- d. *Multiple branches:* If many branches are taken off one feeder, and the branch loads are similar, the largest rated branch-circuit device should be checked for coordination with upstream devices. If the largest branch device will coordinate, and the branch devices are similar, they generally will coordinate as well. (The designer may wish to verify other areas of protection on those branches, conductors, and so forth.)
- e. *Don't overcrowd the study:* Many computer-generated studies will allow a maximum of 10 device characteristics per page. It is good practice, however, to have a minimum of 3 devices in a coordination sequence, so that there is always one step of overlap.
- f. *Existing systems:* The designer should be aware that when conducting a coordination study on an existing system, optimum coordination cannot always be achieved and compromise may be necessary. It is then necessary to exercise experience and judgment to achieve the best coordination possible to mitigate the effects of blackout conditions. The designer must set priorities within the constraints of the system under study.
- g. *Conductor short-circuit protection:* In low-voltage (600 V or less) systems, it is generally safe to ignore possible damage to conductors from short circuits, because the philosophy is to isolate a fault as quickly as possible; thus, the I^2t energy damage curves don't have enough time to come into play (become a factor). In medium- and high-voltage systems, however, in which the philosophy is to have the overcurrent protection "hang in" as long as possible, the contrary is true; therefore, it can be a significant factor.
- h. *One-line diagram:* A one-line diagram of the study should be drawn for future reference.

Example of Selective Coordination Study

INTRODUCTION

The following example will analyze in detail the system shown in Figure 3.17. It is understood that a short-circuit study has been completed, and all protective devices have adequate interrupting ratings. A selective coordination analysis is the next step.

FIGURE 3.17 Example system one-line diagram for selective coordination study.

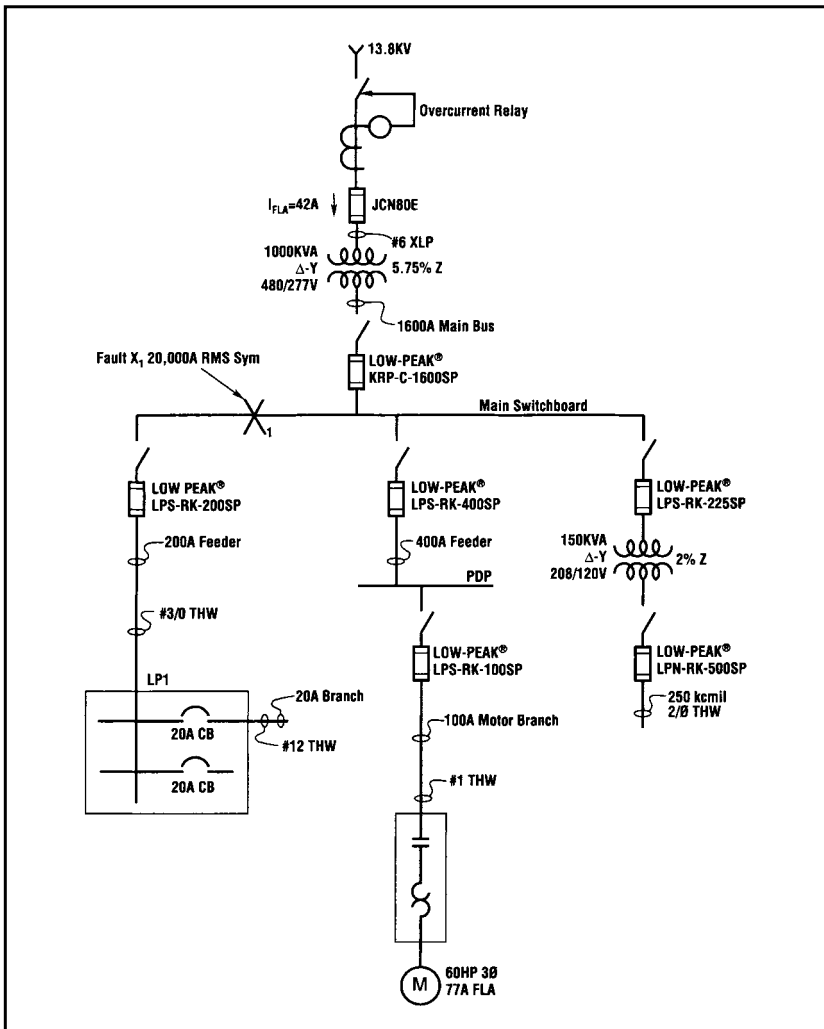

The simple radial system will involve three separate time-current studies, applicable to the three feeder/branches shown. The three time-current curves and their accompanying notes are self-explanatory (Figures 3.18 through 3.20).

FIGURE 3.18 Time-current curve No. 1 for system shown in Figure 3.17 with analysis notes and comments.

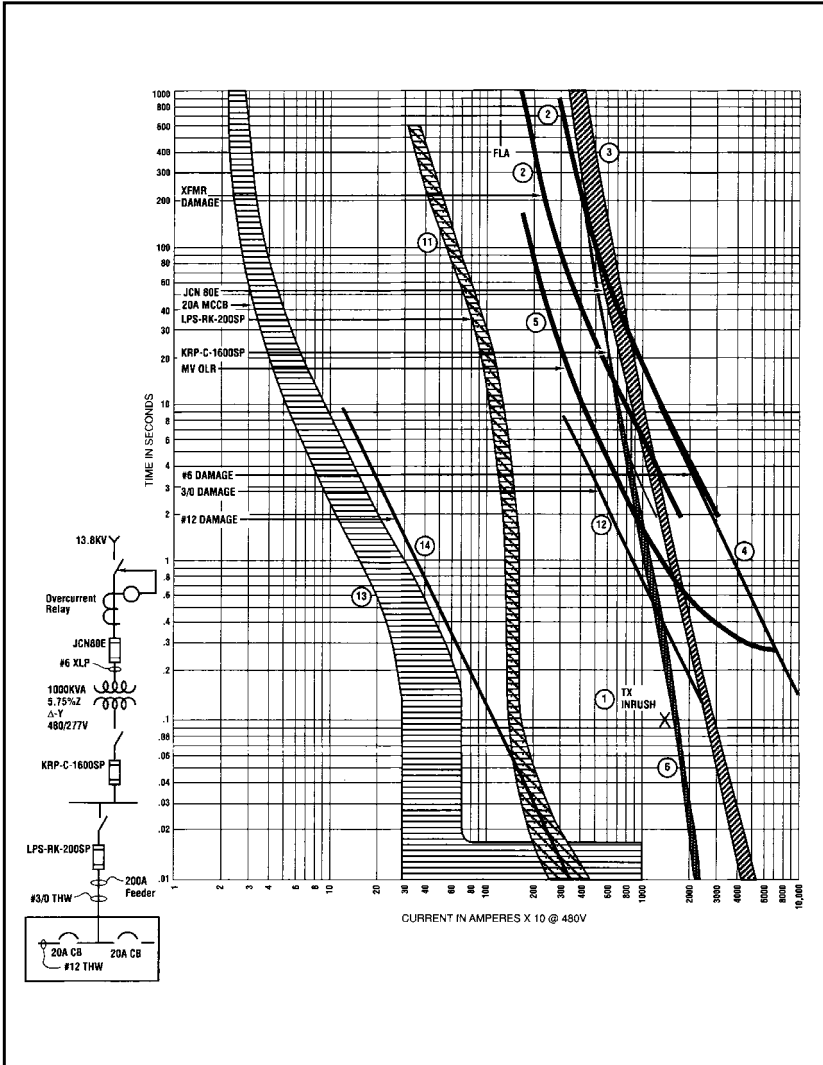

FIGURE 3.18 Time-current curve No. 1 for system shown in Figure 3.17 with analysis notes and comments. (*Continued*)

Notes:

1. TCC1 includes the primary fuse, secondary main fuse, 200 ampere feeder fuse, and 20 ampere branch circuit breaker from LP1.
2. Analysis will begin at the main devices and proceed down through the system.
3. Reference (base) voltage will be 480 volts, arbitrarily chosen since most of the devices are at this level.
4. Selective coordination between the feeder and branch circuit is not attainable for faults above 2500 amperes that occur on the 20 amp branch circuit, from LP1. Notice the overlap of the 200 ampere fuse and 20 ampere circuit breaker.
5. The required minimum ratio of 2:1 is easily met between the KRP-C-1600SP and the LPS-RK-200SP.

<u>Device ID</u>	<u>Description</u>	<u>Comments</u>
①	1000KVA XFMR Inrush Point	12 x FLA @ .1 Seconds
②	1000KVA XFMR Damage Curves	5.75%Z, liquid filled (Footnote 1) (Footnote 2)
③	JCN 80E	E-Rated Fuse
④	#6 Conductor Damage Curve	Copper, XLP Insulation
⑤	Medium Voltage Relay	Needed for XFMR Primary Overload Protection
⑥	KRP-C-1600SP	Class L Fuse
⑪	LPS-RK-200SP	Class RK1 Fuse
⑫	3/0 Conductor Damage Curve	Copper THW Insulation
⑬	20A CB	Thermal Magnetic Circuit Breaker
⑭	#12 Conductor Damage Curve	Copper THW Insulation

Footnote 1: Transformer damage curves indicate when it will be damaged, thermally and/or mechanically, under overcurrent conditions.

Transformer impedance, as well as primary and secondary connections, and type, all will determine their damage characteristics.

Footnote 2: A Δ-Y transformer connection requires a 15% shift, to the right, of the L-L thermal damage curve. This is due to a L-L secondary fault condition, which will cause 1.0 p.u. to flow through one primary phase, and .666 p.u. through the two faulted secondary phases. (These currents are p.u. of 3-phase fault current.)

FIGURE 3.19 Time-current curve No. 2 for system shown in Figure 3.17 with analysis notes and comments.

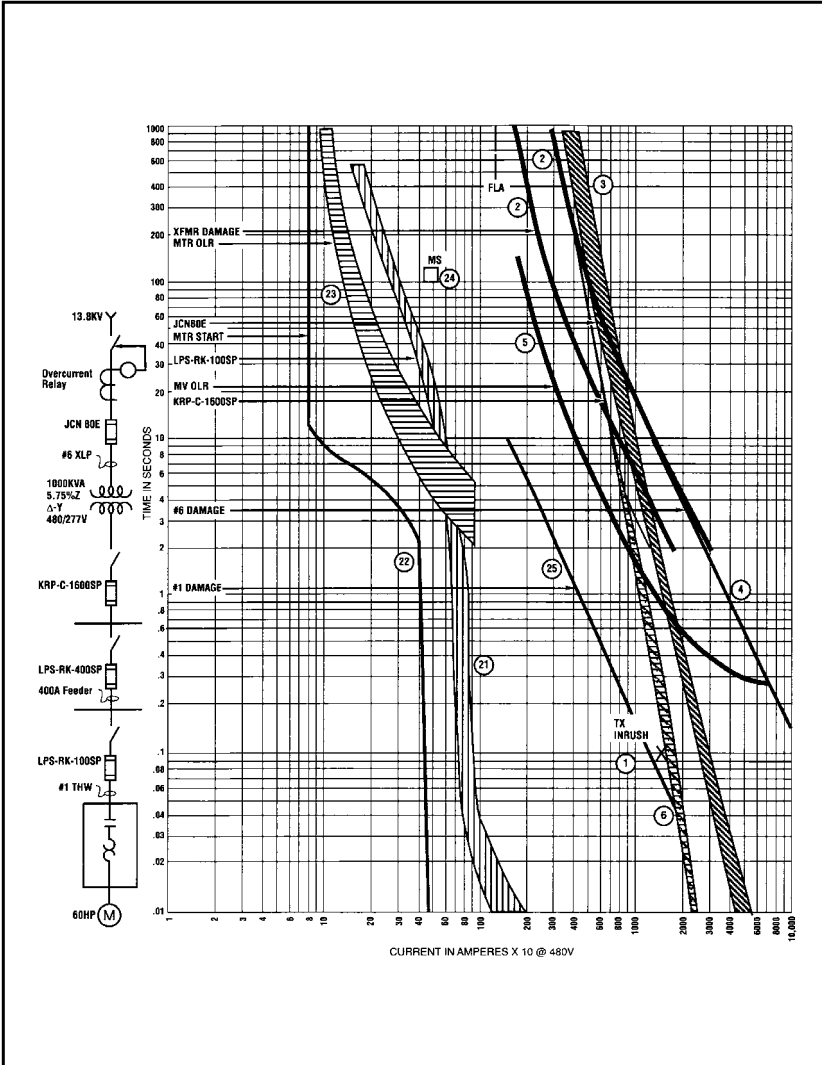

FIGURE 3.19 Time-current curve No. 2 for system shown in Figure 3.17 with analysis notes and comments. (*Continued*)

Notes:

1. TCC2 includes the primary fuse, secondary main fuse, 400 ampere feeder fuse, 100 ampere motor branch fuse, 77 ampere motor and overload relaying.
2. Analysis will begin at the main devices and proceed down through the system.
3. Reference (base) voltage will be 480 volts, arbitrarily chosen since most of the devices are at this level.

<u>Device ID</u>	<u>Description</u>	<u>Comment</u>
①	1000KVA XFMR Inrush Point	12 x FLA @ .1 seconds
②	1000KVA XFMR Damage Curves	5.75%Z, liquid filled (Footnote 1) (Footnote 2)
③	JCN 80E	E-Rated Fuse
④	#6 Conductor Damage Curve	Copper, XLP Insulation
⑤	Medium Voltage Relay	Needed for XFMR Primary Overload Protection
⑥	KRP-C-1600SP	Class L Fuse
⑰	LPS-RK-100SP	Class RK1 Fuse
⑳	Motor Starting Curve	Across the Line Start
㉓	Motor Overload Relay	Class 10
㉔	Motor Stall Point	Part of a Motor Damage Curve
㉕	#1 Conductor Damage Curve	Copper THW Insulation

Footnote 1: Transformer damage curves indicate when it will be damaged, thermally and/or mechanically, under overcurrent conditions.

Transformer impedance, as well as primary and secondary connections, and type, all will determine their damage characteristics.

Footnote 2: A Δ-Y transformer connection requires a 15% shift, to the right, of the L-L thermal damage curve. This is due to a L-L secondary fault condition, which will cause 1.0 p.u. to flow through one primary phase, and .866 p.u. through the two faulted secondary phases. (These currents are p.u. of 3-phase fault current.)

FIGURE 3.20 Time-current curve No. 3 for system shown in Figure 3.17 with analysis notes and comments.

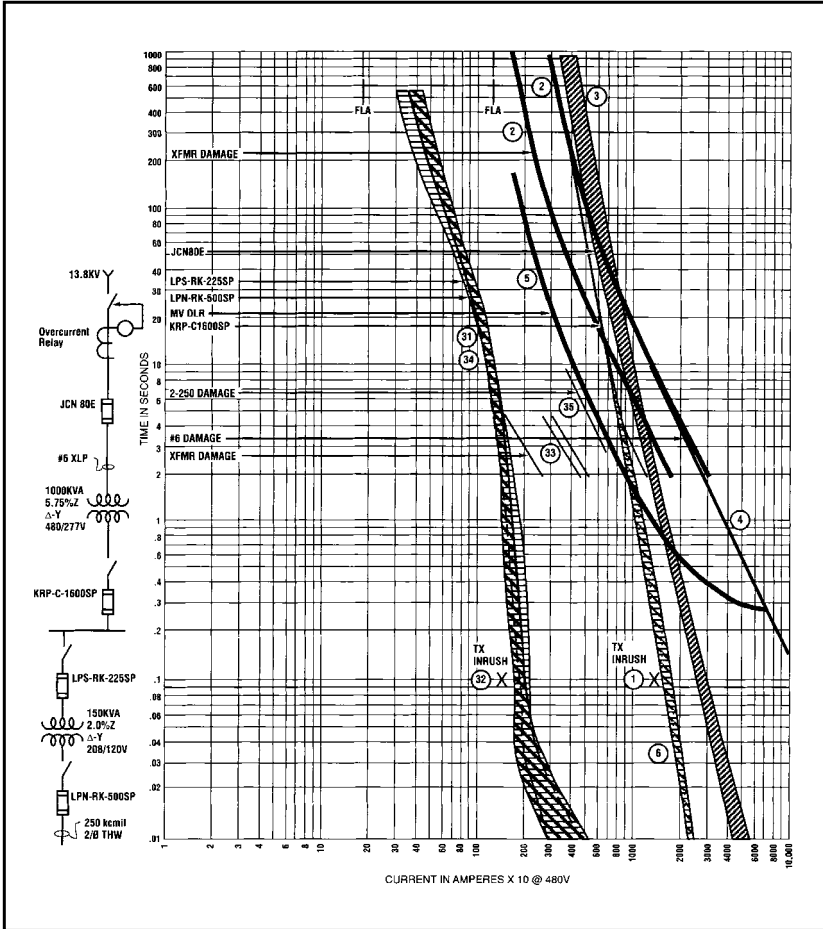

Short-Cut Ratio Method

INTRODUCTION

The selectivity ratio guide in Table 3.23 may be used for an easy check on fuse selectivity regardless of the short-circuit current levels involved. It may also be used for fixed thermal-magnetic trip circuit breakers (exercising good judgment) with a reasonable degree of accuracy. Where medium- and high-voltage primary fuses and relays are involved, the time-current characteristic curves should be plotted on standard log-log graph paper for proper study.

FIGURE 3.20 Time-current curve No. 3 for system shown in Figure 3.17 with analysis notes and comments. (Continued)

Notes:

1. TCC3 includes the primary fuse, secondary main fuse, 225 ampere feeder/transformer primary and secondary fuses.
2. Analysis will begin at the main devices and proceed down through the system.
3. Reference (base) voltage will be 480 volts, arbitrarily chosen since most of the devices are at this level.
4. Relative to the 225 ampere feeder, coordination between primary and secondary fuses is not attainable, noted by overlap of curves.
5. Overload and short circuit protection for the 150 KVA transformer is afforded by the LPS-RK-225SP fuse.

<u>Device ID</u>	<u>Description</u>	<u>Comment</u>
①	1000KVA XFMR Inrush Point	12 x FLA @ .1 seconds
②	1000KVA XFMR Damage Curves	5.75%Z, liquid filled (Footnote 1) (Footnote 2)
③	JCN 80E	E-Rated Fuse
④	#6 Conductor Damage Curve	Copper, XLP Insulation
⑤	Medium Voltage Relay	Needed for XFMR Primary Overload Protection
⑥	KRP-C-1600SP	Class L Fuse
③1	LPS-RK-225SP	Class RK1 Fuse
③2	150 KVA XFMR Inrush Point	12 x FLA @.1 Seconds
③3	150 KVA XFMR Damage Curves	2.00% Dry Type (Footnote 3)
③4	LPN-RK-500SP	Class RK1 Fuse
③5	2-250kcmil Conductors Damage Curve	Copper THW Insulation

Footnote 1: Transformer damage curves indicate when it will be damaged, thermally and/or mechanically, under overcurrent conditions.

Transformer impedance, as well as primary and secondary connections, and type, all will determine their damage characteristics.

Footnote 2: A Δ-Y transformer connection requires a 15% shift, to the right, of the L-L thermal damage curve. This is due to a L-L secondary fault condition, which will cause 1.0 p.u. to flow through one primary phase, and .866 p.u. through the two faulted secondary phases. (These currents are p.u. of 3-phase fault current.)

Footnote 3: Damage curves for a small KVA (<500KVA) transformer, illustrate thermal damage characteristics for Δ-Y connected. From right to left, these reflect damage characteristics, for a line-line fault, 3Ø fault, and L-G fault condition.

TABLE 3.23 Selectivity Ratio Guide

Circuit Current Rating Type	Load-Side Fuse									
	601-6000A Time-Delay (L)	601-4000A Time-Delay (L)	0-600A Dual-Element Time-Delay (L)	601-6000A Time-Delay (L)	601-6000A Fast-Acting (L)	0-600A Fast-Acting (L)	0-1200A T-TRON (J)	0-600A Fast-Acting (J)	0-600A Time-Delay (G)	0-600A Time-Delay (N/A)
Trade Name & Class	LOW-PEAK (L)	LIMITRON (L)	LOW-PEAK (RK1)	FUSETRON (L)	LIMITRON (L)	FUSETRON (RK1)	T-TRON (J)	LIMITRON (RK1)	SC (G)	
Buss Symbol	KRP-CSP	KLU	LPN-RKSP LPS-RKSP LPJSP**	FRN-R FRS-R	KTU	FRN-R FRS-R	JUN JJS	KTN-R KTS-R	SC (G)	
601 to 6000A Delay (L)	2:1	2.5:1	2:1	2:1	2:1	4:1	2:1	2:1	2:1	N/A
601 to 4000A Delay (L)	2:1	2:1	2:1	2:1	2:1	4:1	2:1	2:1	2:1	N/A
0 to 600A Element	–	–	2:1	2:1	–	8:1	3:1	3:1	3:1	4:1
600A Element (RK5)	–	–	1.5:1	1.5:1	–	2:1	1.5:1	1.5:1	1.5:1	1.5:1
601 to 6000A (L)	2:1	2.5:1	2:1	2:1	2:1	6:1	2:1	2:1	2:1	N/A
0 to Fast-Acting (RK1)	–	–	3:1	3:1	–	8:1	–	3:1	3:1	4:1
0 to T-TRON (T)	–	–	3:1	3:1	–	8:1	–	3:1	3:1	4:1
0 to 600A (J)	–	–	2:1	2:1	–	8:1	–	3:1	3:1	4:1
0 to Time-Delay (G)	–	–	3:1	3:1	–	4:1	–	2:1	2:1	2:1

* Note: At some values of fault current, specified ratios may be lowered to permit closer fuse sizing. Plot fuse curves or consult with Busmann.

** Consult Busmann for latest LPJSP ratios.

3.5 COMPONENT SHORT-CIRCUIT PROTECTION

Introduction

This section analyzes the protection of electrical system components from fault currents. It gives the specifier the necessary information regarding the withstand rating of electrical circuit components, such as wire, bus, motor starters, and so on. Proper protection of circuits will improve reliability and reduce the possibility of injury. Electrical systems can be destroyed if the overcurrent devices do not limit the short-circuit current to within the withstand rating of the system's components. Merely matching the ampere rating of a protective device will not assure component protection under short-circuit conditions.

The NEC covers component protection in several sections. The first section to note is NEC Section 110-10.

NEC SECTION 110.10: CIRCUIT IMPEDANCE AND OTHER CHARACTERISTICS

The overcurrent-protective devices, the total impedance, the component short-circuit current ratings, and other characteristics of the circuit to be protected shall be so selected and coordinated as to permit the circuit-protective devices used to clear a fault without the occurrence of extensive damage to the electrical components of the circuit. This fault shall be assumed to be either between two or more circuit conductors, or between any circuit conductor and the grounding conductor or enclosing metal raceway.

This requires that overcurrent-protective devices such as fuses and circuit breakers be selected in such a manner that the short-circuit withstand ratings of the system components will not be exceeded should a short circuit occur.

The *short-circuit withstand rating* is the maximum short-circuit current that a component can safely withstand. Failure to provide adequate protection may result in component destruction under short-circuit conditions.

CALCULATING SHORT-CIRCUIT CURRENTS

Before proceeding with a systems analysis of wire, cable, and other component protection requirements, it will be necessary to establish the short-circuit current levels available at various points in the electrical system. This can be accomplished by using the techniques given in Section 3.3 ("Short-Circuit Calculations"). After calculating the fault levels throughout the electrical system, the next step is to check the withstand ratings of wire and cable, bus, circuit breakers, transfer switches, motor starters, and so forth, not only under overload conditions, but also under short-circuit conditions.

NOTE The let-thru energy of the protective device must be equal to or less than the short-circuit withstand rating of the component being protected.

PROTECTING SYSTEM COMPONENTS—A PRACTICAL APPROACH

Most electrical equipment has a withstand rating that is defined in terms of a root mean square (rms) symmetrical short-circuit current, and in some cases, peak let-thru current. These values have been established through short-circuit testing of that equipment according to an accepted industry standard. Or, as is the case with conductors, the withstand rating is based on a mathematical calculation and is also expressed as an rms symmetrical short-circuit current.

The following provides the short-circuit withstand data of each system component. Please note that where industry standards are given (for example, NEMA), individual manufacturers of equipment often have withstand ratings that exceed industry standards.

- A.** Wire and cable (Figures 3.21 through 3.26 and Table 3.24)
- B.** Bus (busway, switchboards, motor control centers, and panelboards; Table 3.25)
- C.** Low-voltage motor controllers (Table 3.26)
- D.** Molded case circuit breakers (Table 3.27)
- E.** Transformers (Table 3.28)
- F.** Transfer switches (Table 3.29)
- G.** HVAC equipment (Table 3.30)

Current Limitation

DEFINITION OF CURRENT LIMITATION

Today, most electrical distribution systems are capable of delivering very high short-circuit currents, some in excess of 200,000 A. If the components are not capable of handling these short-circuit currents, they could easily be damaged or destroyed. The current-limiting ability of today's modern fuses and current-limiting breakers (with current-limiting fuses) allows components with low short-circuit withstand ratings to be specified in spite of high available fault currents.

NEC Article 240.2 offers the following definition of a current-limiting overcurrent-protective device: A device that, when interrupting currents in its current-limiting range, reduces the current flowing in the faulted circuit to a magnitude substantially less than that obtainable in the same circuit if the device were replaced with a solid conductor having comparable impedance."

FIGURE 3.21 Short-circuit current withstand chart for copper cables with paper, rubber, or varnished cloth insulation.

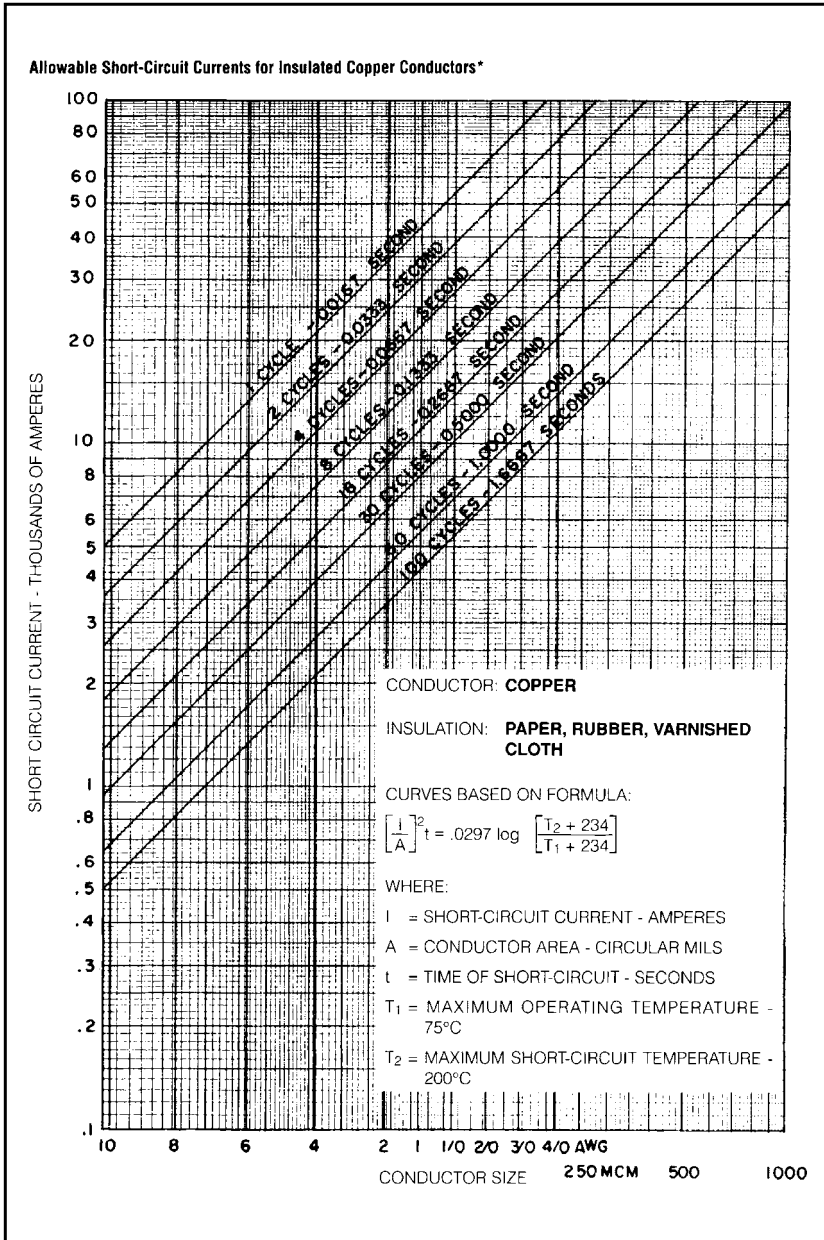

FIGURE 3.22 Short-circuit current withstand chart for copper cables with thermoplastic insulation.

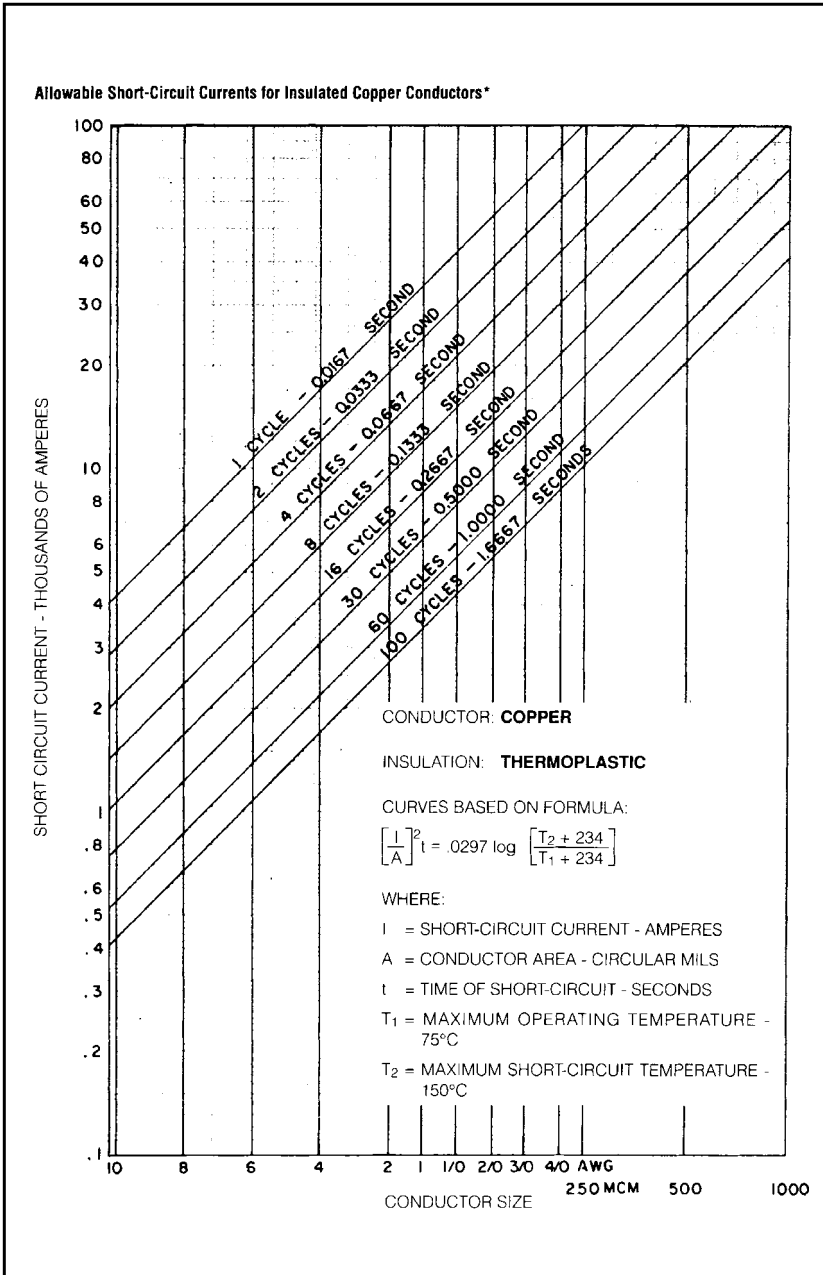

FIGURE 3.23 Short-circuit current withstand chart for copper cables with cross-linked polyethylene and ethylene propylene rubber insulation.

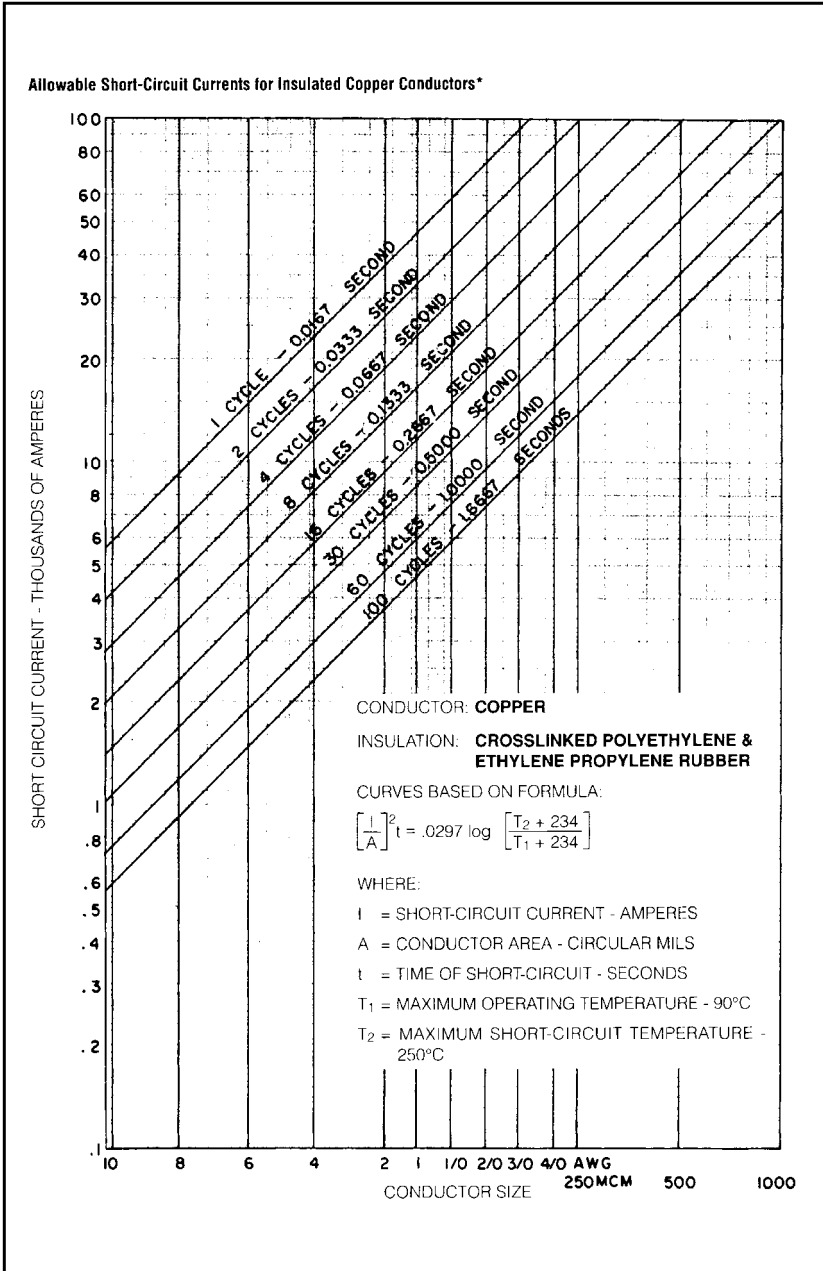

FIGURE 3.24 Short-circuit current withstand chart for aluminum cables with paper, rubber, or varnished cloth insulation.

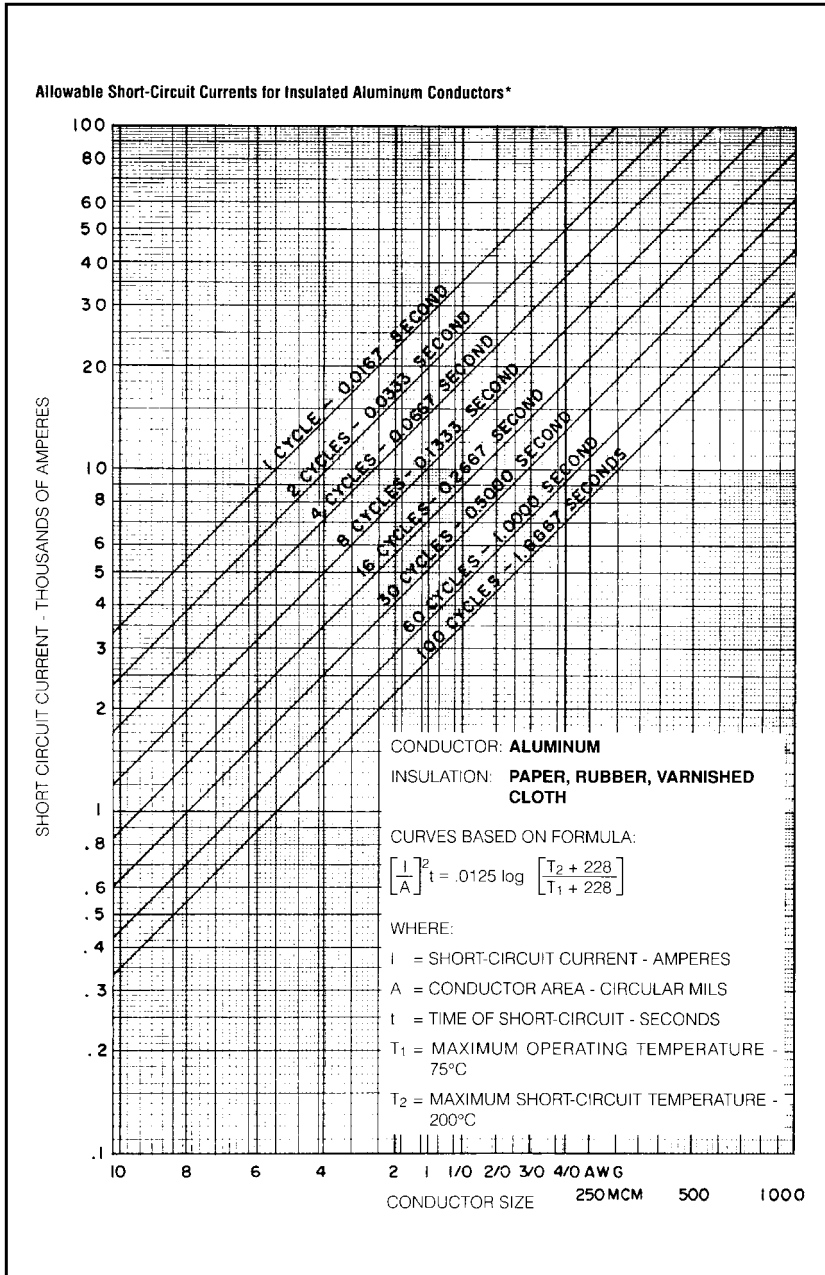

FIGURE 3.25 Short-circuit current withstand chart for aluminum cables with thermoplastic insulation.

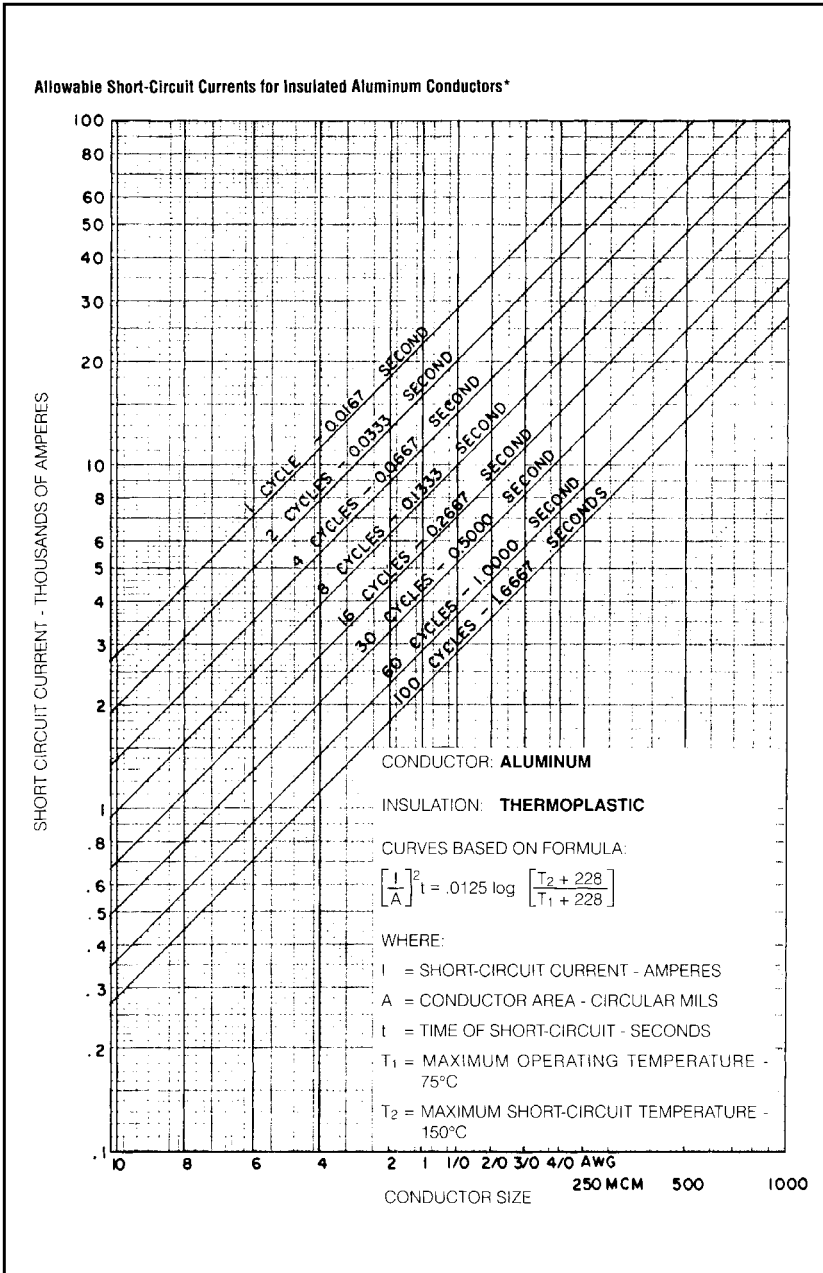

FIGURE 3.26 Short-circuit current withstand chart for aluminum cables with cross-linked polyethylene and ethylene propylene rubber insulation.

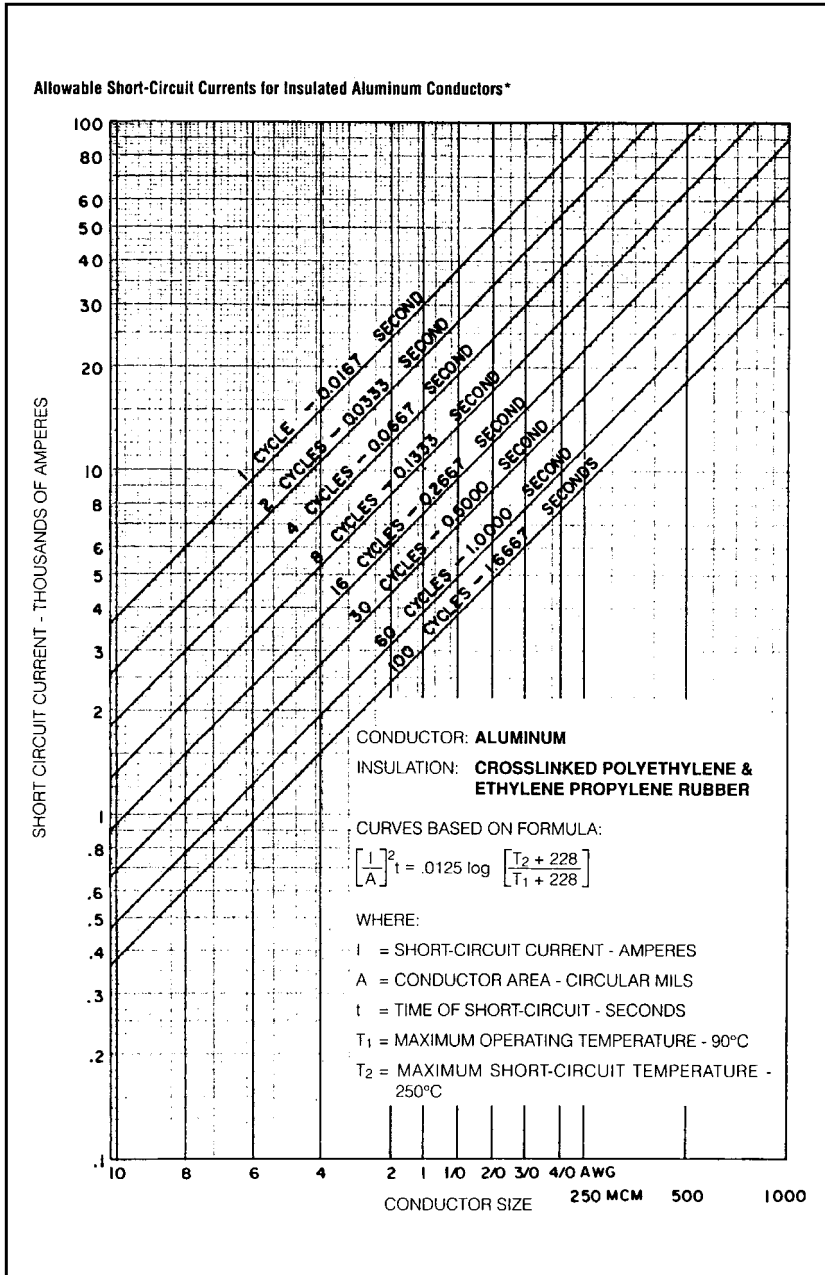

TABLE 3.24 Comparison of Equipment Grounding Conductor Short-Circuit Withstand Ratings

Conductor Size	5 Sec. Rating (Amps)			I²t Rating x10 ⁶ (Ampere Squared Seconds)		
	ICEA P32-382 Insulation Damage	Soares 1 Amp/30 cm Validity	Onderdonk Melting Point	ICEA P32-382 Insulation Damage	Soares 1 Amp/30 cm Validity	Onderdonk Melting Point
	150°C	250°C	1,083°C	150°C	250°C	1,083°C
14	97	137	253	.047	.094	.320
12	155	218	401	.120	.238	.804
10	246	346	638	.303	.599	2.03
8	391	550	1,015	.764	1.51	5.15
6	621	875	1,613	1.93	3.83	13.0
4	988	1,391	2,565	4.88	9.67	32.9
3	1,246	1,754	3,234	7.76	15.4	52.3
2	1,571	2,212	4,078	12.3	24.5	83.1
1	1,981	2,790	5,144	19.6	38.9	132.0
1/0	2,500	3,520	6,490	31.2	61.9	210.0
2/0	3,150	4,437	8,180	49.6	98.4	331.0
3/0	3,972	5,593	10,313	78.9	156.0	532.0
4/0	5,009	7,053	13,005	125.0	248.0	845.0
250	5,918	8,333	15,365	175.0	347.0	1,180.0
300	7,101	10,000	18,438	252.0	500.0	1,700.0
350	8,285	11,667	21,511	343.0	680.0	2,314.0
400	9,468	13,333	24,584	448.0	889.0	3,022.0
500	11,835	16,667	30,730	700.0	1,389.0	4,721.0
600	14,202	20,000	36,876	1,008.0	2,000.0	6,799.0
700	16,569	23,333	43,022	1,372.0	2,722.0	9,254.0
750	17,753	25,000	46,095	1,576.0	3,125.0	10,623.0
800	18,936	26,667	49,168	1,793.0	3,556.0	12,087.0
900	21,303	30,000	55,314	2,269.0	4,500.0	15,298.0
1,000	23,670	33,333	61,460	2,801.0	5,555.0	18,867.0

TABLE 3.25 NEMA (Standard Short-Circuit Ratings of Busway)

Continuous Current Rating of Busway (Amperes)	Short-Circuit Current Ratings (Symmetrical Amperes)	
	Plug-In Duct	Feeder Duct
100	10,000	—
225	14,000	—
400	22,000	—
600	22,000	42,000
800	22,000	42,000
1000	42,000	75,000
1200	42,000	75,000
1350	42,000	75,000
1600	65,000	100,000
2000	65,000	100,000
2500	65,000	150,000
3000	85,000	150,000
4000	85,000	200,000
5000	—	200,000

Table 3 pertains to feeder and plug-in busway. For switchboard and panelboard standard ratings refer to manufacturer.

U.L. Standard 891 details short-circuit durations for busway within switchboards for a minimum of three cycles, unless the main overcurrent device clears the short in less than three cycles.

*Reprinted with permission of NEMA, Pub. No. BU1-1988.

The concept of current limitation is pointed out in Figure 3.27, where the prospective available fault current is shown in conjunction with the limited current resulting when a current-limiting fuse clears. The area under the current curve indicates the amount of short-circuit energy being dissipated in the circuit. Because both magnetic forces and thermal energy are directly proportional to the square of the current, it is important to limit the short-circuit current to as small a value as possible. Magnetic forces vary as the square of the peak current, and thermal energy varies as the square of the rms current.

Thus, the current-limiting fuse in this example would limit the let-thru energy to a fraction of the value that is available from the system. In the first major loop of the fault current, standard non-current-limiting, electromechanical devices would let through approximately 100 times as much destructive energy as the fuse would let through.

TABLE 3.26 U.L. #508 Motor Controller Short-Circuit Test Ratings

Motor Controller HP Rating	Test Short Circuit Current Available
1HP or less and 300V or less	1,000A
50HP or less	5,000A
Greater than 50HP to 200HP	10,000A
201HP to 400HP	18,000A
401HP to 600HP	30,000A
601HP to 900HP	42,000A
901HP to 1600HP	85,000A

It should be noted that these are basic short-circuit requirements. Higher, combination ratings are attainable if tested to an applicable standard. However, damage is usually allowed.

ANALYSIS OF CURRENT-LIMITING FUSE LET-THRU CHARTS

The degree of current limitation of a given size and type of fuse depends, in general, upon the available short circuit that can be delivered by the electrical system. Current limitation of fuses is best described in the form of a let-thru chart, which, when applied from a practical point of view, is useful to determine the let-thru currents when a fuse opens.

Fuse let-thru charts are similar to the one shown in Figure 3.28 and are plotted from actual test data. The test circuit that establishes line A-B corresponds to a short-circuit power factor of 15 percent, which is associated with an X/R ratio of 6.6. The fuse curves represent the cutoff value of the prospective available short-circuit current under the given circuit conditions. Each type or class of fuse has its own family of let-thru curves.

The let-thru data has been generated by actual short-circuit tests of current-limiting fuses. It is important to understand how the curves are generated, and what circuit parameters affect the let-thru curve data. Typically, there are three circuit parameters that can affect fuse let-thru performance for a given available short-circuit current. These are:

1. Short-circuit power factor
2. Short-circuit closing angle
3. Applied voltage

Current-limiting fuse let-thru curves are generated under worst-case conditions, based on these three variable parameters. The benefit to the user is a conservative resultant let-thru current (both I_p and I_{rms}). Under actual field conditions, changing any one or a combination of these will result in lower let-thru currents. This provides for an additional degree of reliability when applying fuses for equipment protection.

TABLE 3.27 Molded-Case Circuit Breaker Interrupting Capacities

SIEMENS						SQUARE D				
Frame Size	Maximum Voltage Rating	Breaker Type	Ampere Rating	UL Interruption Capacity Symm./RMS	Dimensions (inches)	Breaker Type	Ampere Rating	UL Interruption Capacity Symm./RMS/AC	Dimensions (inches)	
100A	Standard/Interrupting 240V AC 250V DC	ED2	15-100	120V AC 10 kA-1 Pole	W-1 H-1 D-1	FAL	15-100	120V AC 10 kA-1 Pole	W-1 1/2 H-3 D-3 1/2	
				240V AC 10 kA-2, 3 Pole	W-2 H-2 D-2			240V AC 10 kA-2, 3 Pole	W-2 1/2 H-3 D-3 1/2	
	Standard/Interrupting 480V AC 250V DC	ED4	15-125	120V AC 65 kA-1 Pole	W-1 H-1 D-1	FAL	15-100	120V AC 25 kA-1 Pole	W-1 1/2 H-3 D-3 1/2	
				240V AC 65 kA-2, 3 Pole	W-2 H-2 D-2			240V AC 25 kA-2, 3 Pole	W-2 1/2 H-3 D-3 1/2	
	Standard/Interrupting 600V AC 500V DC	ED6	15-125	120V AC 100 kA-1 Pole	W-1 H-1 D-1	FAL	15-100	240V AC 25 kA-2, 3 Pole	W-1 1/2 H-3 D-3 1/2	
				240V AC 100 kA-2, 3 Pole	W-2 H-2 D-2			480V AC 18 kA-2, 3 Pole	W-1 1/2 H-3 D-3 1/2	
125A	High/Interrupting 600V AC 250V DC	HED6	15-125	120V AC 100 kA-1 Pole	W-1 H-1 D-1	FCL	15-100	240V AC 100 kA-2, 3 Pole	W-3 H-3 D-3 1/2	
				277V AC (15-30 Ampere) 65 kA-1 Pole	W-1 1/2 H-1 1/2 D-1			480V AC 65 kA-2, 3 Pole	W-3 H-3 D-3 1/2	
	High/Interrupting 600V AC 500V DC	HFD6	15-125	240V AC 100 kA-2, 3 Pole	W-2 H-2 D-2	FHL	15-100	240V AC 65 kA-2, 3 Pole	W-2 1/2 H-3 D-3 1/2	
				480V AC 30 kA-2, 3 Pole	W-2 1/2 H-2 1/2 D-2			480V AC 25 kA-2, 3 Pole	W-2 1/2 H-3 D-3 1/2	
	Current Limiting 600V AC 500V DC	CED6	15-125	240V AC 200 kA-2, 3 Pole	W-2 H-2 D-2	FL	15-100	240V AC 200 kA-2, 3 Pole	W-4 1/2 H-3 D-3 1/2	
				480V AC 700 kA-2, 3 Pole	W-2 1/2 H-2 1/2 D-2			480V AC 200 kA-2, 3 Pole	W-4 1/2 H-3 D-3 1/2	
225A	240V AC 2 or 3 Pole Construction	QJ2	60-725	240V AC 10 kA-2, 3 Pole	W-3 H-3 D-3 1/2	QZL	100-225	240V AC 10 kA-2, 3 Pole	W-3 H-3 D-3 1/2	
		QJH2	60-725	240V AC 22 kA-2, 3 Pole	W-3 H-3 D-3 1/2		100-225	240V AC 22 kA-2, 3 Pole	W-3 H-3 D-3 1/2	
		QJ2-H	60-725	240V AC 42 kA-2, 3 Pole	W-3 H-3 D-3 1/2		100-225	240V AC 42 kA-2, 3 Pole	W-3 H-3 D-3 1/2	
250A	Standard/Interrupting 600V AC 500V DC	FXD6	70-250	240V AC 65 kA-2, 3 Pole	W-4 H-4 D-4	KAL	70-250	240V AC 42 kA-2, 3 Pole	W-4 1/2 H-4 D-4 1/2	
		FXD6	70-250	480V AC 25 kA-2, 3 Pole	W-4 H-4 D-4		70-250	480V AC 25 kA-2, 3 Pole	W-4 1/2 H-4 D-4 1/2	
	High/Interrupting 600V AC 500V DC	HFD6	70-250	240V AC 100 kA-2, 3 Pole	W-4 H-4 D-4	KHL	70-250	240V AC 65 kA-2, 3 Pole	W-4 1/2 H-4 D-4 1/2	
		HFD6	70-250	480V AC 30 kA-2, 3 Pole	W-4 H-4 D-4			480V AC 25 kA-2, 3 Pole	W-4 1/2 H-4 D-4 1/2	
	Current Limiting 600V AC 500V DC	CFD6	70-250	240V AC 200 kA-2, 3 Pole	W-4 H-4 D-4	KIL	110-250	240V AC 200 kA-2, 3 Pole	W-4 1/2 H-4 D-4 1/2	
		CFD6	70-250	480V AC 100 kA-2, 3 Pole	W-4 H-4 D-4		110-250	480V AC 100 kA-2, 3 Pole	W-4 1/2 H-4 D-4 1/2	
400A	Standard/Interrupting 600V AC 500V DC	JXD2	200-400	240V AC 65 kA-2, 3 Pole	W-7 H-7 D-7	DL	250-400	240V AC 25 kA-2, 3 Pole	W-6 H-6 D-6 1/2	
		JXD6	200-400	240V AC 65 kA-2, 3 Pole	W-7 H-7 D-7		125-400	240V AC 42 kA-2, 3 Pole	W-6 H-6 D-6 1/2	
	High/Interrupting 600V AC 500V DC	HXD6	200-400	240V AC 100 kA-2, 3 Pole	W-7 H-7 D-7	LHL	125-400	240V AC 65 kA-2, 3 Pole	W-7 1/2 H-7 1/2 D-7 1/2	
		HXD6	200-400	480V AC 35 kA-2, 3 Pole	W-7 H-7 D-7			240V AC 25 kA-2, 3 Pole	W-7 1/2 H-7 1/2 D-7 1/2	
		High/Interrupting 600V AC	HHXD6	200-400	240V AC 200 kA-2, 3 Pole	W-7 H-7 D-7	Not Available	200-400	240V AC 100 kA-2, 3 Pole	W-7 1/2 H-7 1/2 D-7 1/2
			HHXD6	200-400	480V AC 100 kA-2, 3 Pole	W-7 H-7 D-7			480V AC 25 kA-2, 3 Pole	W-7 1/2 H-7 1/2 D-7 1/2
	Current Limiting 600V AC 500V DC	CJD6	200-400	240V AC 200 kA-2, 3 Pole	W-7 H-7 D-7	LH	300-400	240V AC 200 kA-2, 3 Pole	W-7 1/2 H-7 1/2 D-7 1/2	
		CJD6	200-400	480V AC 100 kA-2, 3 Pole	W-7 H-7 D-7		300-400	480V AC 100 kA-2, 3 Pole	W-7 1/2 H-7 1/2 D-7 1/2	
	Standard/Interrupting 600V AC	SJD6	200-400	240V AC 65 kA-2, 3 Pole	W-7 H-7 D-7	Not Available	200-400	240V AC 25 kA-2, 3 Pole	W-7 1/2 H-7 1/2 D-7 1/2	
		SJD6	200-400	480V AC 35 kA-2, 3 Pole	W-7 H-7 D-7			240V AC 100 kA-2, 3 Pole	W-7 1/2 H-7 1/2 D-7 1/2	
	High/Interrupting 600V AC	SHJD6	200-400	240V AC 100 kA-2, 3 Pole	W-7 H-7 D-7	LHL	300-400	240V AC 65 kA-2, 3 Pole	W-7 1/2 H-7 1/2 D-7 1/2	
		SHJD6	200-400	480V AC 35 kA-2, 3 Pole	W-7 H-7 D-7			480V AC 25 kA-2, 3 Pole	W-7 1/2 H-7 1/2 D-7 1/2	
	Current Limiting 600V AC	SCJD6	200-400	240V AC 200 kA-2, 3 Pole	W-7 H-7 D-7	Not Available	300-400	240V AC 200 kA-2, 3 Pole	W-7 1/2 H-7 1/2 D-7 1/2	
		SCJD6	200-400	480V AC 100 kA-2, 3 Pole	W-7 H-7 D-7			480V AC 100 kA-2, 3 Pole	W-7 1/2 H-7 1/2 D-7 1/2	

WESTINGHOUSE				GENERAL ELECTRIC				CUTLER-HAMMER			
Breaker Type	Ampere Rating	UL Interruption Capacity System RMS (A/C)	Dimensions inches	Breaker Type	Ampere Rating	UL Interruption Capacity System RMS (A/C)	Dimensions inches	Breaker Type	Ampere Rating	UL Interruption Capacity System RMS (A/C)	Dimensions inches
EB	15-100	120V AC 10 kA-2.3 Pole 240V AC 10 kA-2.3 Pole 125V DC 5 kA-1 Pole 250V DC 5 kA-2.3 Pole	W-1 1/2 (1 Pole) W-2 1/2 (2 Pole) W-3 1/2 (3 Pole) H-1 1/2 D-3 1/2	TEB	15-100	120V AC 10 kA-1 Pole 240V AC 10 kA-2.3 Pole 125V DC 5 kA-1 Pole 250V DC 5 kA-2.3 Pole	W-1 1/2 (1 Pole) W-2 1/2 (2 Pole) W-3 1/2 (3 Pole) H-1 1/2 D-3 1/2	FS	15-100	120V AC 65 kA-1 Pole (15-30 Amperes) 240V AC 10 kA-2.3 Pole 250V DC 10 kA-2 Pole	W-1 1/2 (1 Pole) (2 Pole) (3 Pole) H-1 1/2 D-3 1/2
E+D	15-100	240V AC 18 kA-2.3 Pole 277V AC 14 kA-1 Pole 480V AC 14 kA-2.3 Pole 125V DC 10 kA-1 Pole 250V DC 10 kA-2.3 Pole	W-1 1/2 (1 Pole) W-2 1/2 (2 Pole) W-3 1/2 (3 Pole) H-1 1/2 D-3 1/2	TED	15-100	240V AC 18 kA-2.3 Pole 277V AC 14 kA-1 Pole 480V AC 14 kA-2.3 Pole 250V DC 10 kA-2.3 Pole	W-1 1/2 (1 Pole) W-2 1/2 (2 Pole) W-3 1/2 (3 Pole) H-1 1/2 D-3 1/2	FS	15-150	2120V AC 65 kA-1 Pole 277V AC 22 kA-2 Pole (15-30 Amperes) 240V AC 22 kA-2.3 Pole 480V AC 14 kA-2.3 Pole 250V DC 10 kA-2 Pole	W-1 1/2 (1 Pole) W-2 1/2 (2 Pole) (3 Pole) H-1 1/2 D-3 1/2
HD	15-150	240V AC 65 kA-2.3 Pole 480V AC 25 kA-2.3 Pole 600V AC 18 kA-2.3 Pole 250V DC 10 kA-2.3 Pole		THD	15-100	240V AC 18 kA-2.3 Pole 480V AC 18 kA-2.3 Pole 600V AC 14 kA-2.3 Pole 250V DC 10 kA-2 Pole 500V DC 10 kA-3 Pole		FS	15-150	240V AC 22 kA-3 Pole 480V AC 14 kA-3 Pole 600V AC 14 kA-3 Pole 250V DC 10 kA-3 Pole	W-1 1/2 (1 Pole) W-2 1/2 (2 Pole) (3 Pole) H-1 1/2 D-3 1/2
HFD	15-150	240V AC 100 kA-2.3 Pole 277V AC 65 kA-1 Pole 480V AC 65 kA-2.3 Pole 125V DC 10 kA-1 Pole 250V DC 10 kA-2.3 Pole	W-1 1/2 (1 Pole) W-2 1/2 (2 Pole) W-3 1/2 (3 Pole) H-1 1/2 D-3 1/2	THED	15-150	240V AC (15-100 Amperes) 65 kA-2.3 Pole 277V AC (110-150 Amperes) 42 kA-2.3 Pole 277V AC (15-30 Amperes) 65 kA-1 Pole 480V AC 25 kA-2.3 Pole 250V DC 10 kA-2.3 Pole	W-1 1/2 (1 Pole) W-2 1/2 (2 Pole) W-3 1/2 (3 Pole) H-1 1/2 D-3 1/2	FH	15-150	240V AC 100 kA-3 Pole 480V AC 30 kA-3 Pole	W-1 1/2 (1 Pole) W-2 1/2 (2 Pole) (3 Pole) H-1 1/2 D-3 1/2
HFD	15-150	240V AC 100 kA-2.3 Pole 480V AC 65 kA-2.3 Pole 600V AC 25 kA-2.3 Pole 250V DC 10 kA-2.3 Pole		THED	15-150	240V AC (15-100 Amperes) 65 kA-2.3 Pole 277V AC (110-150 Amperes) 42 kA-2.3 Pole 277V AC (15-30 Amperes) 65 kA-1 Pole 480V AC 25 kA-2.3 Pole 250V DC 10 kA-2.3 Pole		FH	15-150	240V AC 100 kA-3 Pole 480V AC 30 kA-3 Pole 600V AC 18 kA-3 Pole 250V DC 10 kA-2.3 Pole	
FDC	15-150	240V AC 200 kA-2.3 Pole 480V AC 100 kA-2.3 Pole 600V AC 65 kA-2.3 Pole 250V DC 25 kA-2.3 Pole		THFC1	15-150	240V AC 200 kA-3 Pole 480V AC (15-30 Amperes) 150 kA-2 Pole 600V AC (60-150 Amperes) 200 kA-3 Pole 600V AC 50 kA-3 Pole		FL Type Circuit Breaker	15-100	240V AC 200 kA-2.3 Pole 480V AC 100 kA-2.3 Pole 600V AC 25 kA-2.3 Pole 250V DC 10 kA-2.3 Pole	W-1 1/2 (1 Pole) H-1 1/2 D-3 1/2
CA	125-225	240V AC 10 kA-2.3 Pole		TQD	240V AC 10 kA-2.3 Pole			CC	60-225	240V AC 10 kA-2.3 Pole	W-2 1/2 (2 Pole) W-3 1/2 (3 Pole) H-1 1/2 D-3 1/2
CAH	125-225	240V AC 22 kA-2.3 Pole		THQD	240V AC 22 kA-2.3 Pole			CCH	125-225	240V AC 28 kA-2.3 Pole	W-4 1/2 (4 Pole) (3 Pole) H-1 1/2 D-3 1/2
HCA	125-225	240V AC 42 kA-2.3 Pole						CHH	60-225	240V AC 100 kA-2.3 Pole	W-4 1/2 (4 Pole) H-1 1/2 D-3 1/2
JDB Air-Trap Interchangeable Trip	70-250	240V AC 65 kA-2.3 Pole 480V AC 25 kA-2.3 Pole 600V AC 18 kA-2.3 Pole 250V DC 10 kA-2 Pole	W-4 1/2 (4 Pole) H-1 1/2 D-3 1/2	THFK Interchangeable Trip	70-250	240V AC 25 kA-2.3 Pole 480V AC 18 kA-2.3 Pole 600V AC 14 kA-2.3 Pole	W-4 1/2 (4 Pole) H-1 1/2 D-3 1/2	JS Air-Trap	100-250	240V AC 25 kA-3 Pole 480V AC 22 kA-3 Pole 600V AC 14 kA-3 Pole 250V DC 10 kA-3 Pole	W-4 1/2 (4 Pole) H-1 1/2 D-3 1/2
HJD Interchangeable Trip	70-250	240V AC 100 kA-2.3 Pole 480V AC 65 kA-2.3 Pole 600V AC 25 kA-2.3 Pole 250V DC 22 kA-2 Pole 500V DC 20 kA-3 Pole		THFC Interchangeable Trip	70-250	240V AC 100 kA-3 Pole 480V AC 65 kA-3 Pole 600V AC 25 kA-3 Pole		JH Air-Trap	100-250	240V AC 100 kA-3 Pole 480V AC 30 kA-3 Pole 600V AC 18 kA-3 Pole 250V DC 10 kA-3 Pole	
Not Available				Not Available				Not Available			
JDC Interchangeable Trip	70-250	240V AC 200 kA-2.3 Pole 480V AC 100 kA-2.3 Pole 600V AC 65 kA-2.3 Pole 250V DC 25 kA-2.3 Pole		THLC2 Intertrip	125-225	240V AC 200 kA-3 Pole 480V AC 200 kA-3 Pole 600V DC 50 kA-3 Pole	W-5 1/2 (5 Pole) H-1 1/2 D-3 1/2	JL Air-Trap Interchangeable Trip	100-250	240V AC 200 kA-3 Pole 480V AC 100 kA-3 Pole 600V AC 25 kA-3 Pole 250V DC 10 kA-3 Pole	
DK Air-Trap	250-400	240V AC 65 kA-2.3 Pole 250V DC 10 kA-2.3 Pole	W-5 1/2 (5 Pole) H-1 1/2 D-3 1/2	TJD Air-Trap	250-400	240V AC 22 kA-2.3 Pole 250V DC 10 kA-2 Pole	W-5 1/2 (5 Pole) H-1 1/2 D-3 1/2	KS Air-Trap	250-400	240V AC 65 kA-2.3 Pole 250V DC 10 kA-2.3 Pole	
KDB Air-Trap	130-400	240V AC 65 kA-2.3 Pole 480V AC 25 kA-2.3 Pole 600V AC 18 kA-2.3 Pole 250V DC 10 kA-2.3 Pole		TJJ Air-Trap	125-400	240V AC 42 kA-2.3 Pole 480V AC 30 kA-2.3 Pole 600V AC 22 kA-2.3 Pole 250V DC 10 kA-2 Pole 500V DC 20 kA-2 Pole		KS Air-Trap	100-400	240V AC 42 kA-3 Pole 480V AC 30 kA-3 Pole 600V AC 14 kA-3 Pole 250V DC 10 kA-3 Pole	W-5 1/2 (5 Pole) H-1 1/2 D-3 1/2 400 D-3 1/2
KD Interchangeable Trip	130-400	240V AC 65 kA-2.3 Pole 480V AC 25 kA-2.3 Pole 600V AC 18 kA-2.3 Pole 250V DC 10 kA-2.3 Pole		TJK Interchangeable Trip	125-400	240V AC 65 kA-2.3 Pole 480V AC 30 kA-2.3 Pole 600V AC 22 kA-2.3 Pole 250V DC 10 kA-2 Pole 500V DC 20 kA-2 Pole		KH Air-Trap	100-400	240V AC 65 kA-3 Pole 480V AC 30 kA-3 Pole 600V AC 18 kA-3 Pole 250V DC 10 kA-3 Pole	
HKD Interchangeable Trip	130-400	240V AC 100 kA-2.3 Pole 480V AC 65 kA-2.3 Pole 600V AC 25 kA-2.3 Pole 250V DC 22 kA-2.3 Pole 500V DC 25 kA-3 Pole	W-6 1/2 (6 Pole) H-1 1/2 D-3 1/2	THJK Interchangeable Trip	125-400	240V AC 100 kA-3 Pole 480V AC 65 kA-3 Pole 600V AC 25 kA-3 Pole 250V DC 10 kA-2 Pole	W-6 1/2 (6 Pole) H-1 1/2 D-3 1/2				
Current-Limiting FDC Interchangeable Trip	130-400	240V AC 200 kA-2.3 Pole 480V AC 100 kA-2.3 Pole 600V AC 65 kA-2.3 Pole 250V DC 22 kA-2.3 Pole		Current-Limiting THLB Air-Trap	250-400	240V AC 100 kA-3 Pole 480V DC 65 kA-3 Pole 600V AC 25 kA-3 Pole		Not Available			
Current-Limiting LCL Air-Trap	125-400	240V AC 200 kA-2.3 Pole 480V AC 100 kA-2.3 Pole 600V AC 100 kA-2.3 Pole	W-8 1/2 (8 Pole) H-1 1/2 D-3 1/2	THLC4 Air-Trap	250-400	240V AC 200 kA-3 Pole 480V AC 200 kA-3 Pole 600V AC 50 kA-3 Pole	W-5 1/2 (5 Pole) H-1 1/2 D-3 1/2	Not Available			
SoftStart KD	125-400	240V AC 65 kA-3 Pole 480V AC 25 kA-3 Pole 600V DC 25 kA-3 Pole	W-5 1/2 (5 Pole) H-1 1/2 D-3 1/2	SoftStart THJLV	150-400	240V AC 65 kA-3 Pole 480V AC 30 kA-3 Pole 600V AC 25 kA-3 Pole		SoftStart KS	400	240V AC 42 kA-3 Pole 480V AC 22 kA-3 Pole 600V AC 14 kA-3 Pole	W-5 1/2 (5 Pole) H-1 1/2 D-3 1/2
SoftStart HKD	125-400	240V AC 100 kA-3 Pole 480V AC 65 kA-3 Pole 600V AC 25 kA-3 Pole	W-5 1/2 (5 Pole) H-1 1/2 D-3 1/2	SoftStart THJVV	150-400	240V AC 100 kA-3 Pole 480V AC 65 kA-3 Pole 600V AC 30 kA-3 Pole		SoftStart KH	400	240V AC 65 kA-3 Pole 480V AC 35 kA-3 Pole 600V AC 22 kA-3 Pole	W-5 1/2 (5 Pole) H-1 1/2 D-3 1/2
SoftStart KDC	125-400	240V AC 200 kA-3 Pole 480V AC 100 kA-3 Pole 600V AC 60 kA-3 Pole	W-5 1/2 (5 Pole) H-1 1/2 D-3 1/2	Not Available				Not Available			

TABLE 3.27 Molded-Case Circuit Breaker Interrupting Capacities
(Continued)

SIEMENS					SQUARE D				
600A	Standard Interrupting 600V AC 500V DC	LD6 Interchangeable Trip	250-600	240V AC 65 kA-2, 3 Pole 480V AC 35 kA-2, 3 Pole 600V AC 25 kA-2, 3 Pole 250V DC 30 kA-2 Pole 500V DC 25 kA-3 Pole		Not Available			
	High Interrupting 600V AC 600V DC	HLXD6 Interchangeable Trip	250-600	240V AC 100 kA-2, 3 Pole 480V AC 65 kA-2, 3 Pole 600V AC 35 kA-2, 3 Pole 250V DC 30 kA-2 Pole 500V DC 25 kA-3 Pole	W-77b H=11 D=4	LCL Type	300-600	240V AC 100 kA-2, 3 Pole 480V AC 65 kA-2, 3 Pole 600V AC 35 kA-2, 3 Pole	W-77b H=17 1/2 D=4
	High Interrupting ^① 600 Amperes 600V AC	HHLXD6S Sika Trip HHLXD6Z Sika Trip	250-600	240V AC 200 kA-2, 3 Pole 480V AC 100 kA-2, 3 Pole 600V AC 50 kA-2, 3 Pole		Not Available			
	Current Limiting 600V AC 600V DC	CLD6 Type	450-600	240V AC 200 kA-3 Pole 480V AC 150 kA-3 Pole 600V AC 100 kA-3 Pole 250V DC 30 kA-2 Pole 500V DC 20 kA-2 Pole	W-77c H=17 1/2 D=4	UL Type	450-600	240V AC 200 kA-2, 3 Pole 480V AC 100 kA-2, 3 Pole 600V AC 100 kA-2, 3 Pole	W-77c H=17 1/2 D=4
800A	Standard Interrupting 600V AC	Sika Trip SLD6	300-600	240V AC 65 kA-3 Pole 480V AC 35 kA-3 Pole 600V AC 25 kA-3 Pole	W-77c H=11 D=4	Not Available			
	High Interrupting 600V AC	Sika Trip SHLD6	300-600	240V AC 100 kA-3 Pole 480V AC 65 kA-3 Pole 600V AC 50 kA-3 Pole		UL Type	400-600	240V AC 100 kA-3 Pole 480V AC 65 kA-3 Pole 600V AC 35 kA-3 Pole	W-77c H=11 1/2 D=5 1/2
	Current Limiting 600V AC	Sika Trip SCLD6	300-600	240V AC 200 kA-3 Pole 480V AC 150 kA-3 Pole 600V AC 100 kA-3 Pole	W-77c H=17 1/2 D=4	UL Type	400-600	240V AC 200 kA-3 Pole 480V AC 200 kA-3 Pole 600V AC 100 kA-3 Pole	W-77c H=17 1/2 D=5 1/2
	Standard Interrupting 600V AC 500V DC	MND6 Interchangeable Trip	500-800	240V AC 65 kA-2, 3 Pole 480V AC 35 kA-2, 3 Pole 600V AC 25 kA-2, 3 Pole 250V DC 30 kA-2 Pole 500V DC 25 kA-3 Pole	W-9 H=16 D=6 1/2	MNL Type	300-1000	240V AC 65 kA-2, 3 Pole 480V AC 35 kA-2, 3 Pole 600V AC 25 kA-2, 3 Pole 250V DC 30 kA-2 Pole 500V DC 25 kA-3 Pole	W-9 H=14
High Interrupting 600V AC 500V DC	HHLND6 Interchangeable Trip	500-800	240V AC 100 kA-2, 3 Pole 480V AC 65 kA-2, 3 Pole 600V AC 50 kA-2, 3 Pole 250V DC 30 kA-2 Pole 500V DC 25 kA-3 Pole		MHL Type	300-1000	240V AC 65 kA-2, 3 Pole 480V AC 35 kA-2, 3 Pole 600V AC 25 kA-2, 3 Pole 250V DC 30 kA-2 Pole 500V DC 25 kA-3 Pole	W-9 H=14 D=6 1/2	
Current Limiting ^② 600V AC 500V DC	CLND6 Type	500-800	240V AC 200 kA-3 Pole 480V AC 100 kA-3 Pole 600V AC 65 kA-3 Pole 250V DC 30 kA-2 Pole 500V DC 50 kA-3 Pole		Not Available				
Standard Interrupting 600V AC	Sika Trip SMD6	600-800	240V AC 65 kA-3 Pole 480V AC 50 kA-3 Pole 600V AC 25 kA-3 Pole		UL Type	450-800	240V AC 65 kA-3 Pole 480V AC 65 kA-3 Pole 600V AC 25 kA-3 Pole	W-9 H=14 1/2 D=6 1/2	
High Interrupting 600V AC	Sika Trip SHMD6	600-800	240V AC 100 kA-3 Pole 480V AC 65 kA-3 Pole 600V AC 50 kA-3 Pole		Not Available				
Current Limiting 600V AC	Sika Trip SCLMD6	600-800	240V AC 200 kA-3 Pole 480V AC 100 kA-3 Pole 600V AC 65 kA-3 Pole		Not Available				
1200A	Standard Interrupting 600V AC 500V DC	NXD6 Interchangeable Trip	800-1200	240V AC 65 kA-2, 3 Pole 480V AC 50 kA-2, 3 Pole 600V AC 25 kA-2, 3 Pole 250V DC 30 kA-3 Pole 500V DC 25 kA-3 Pole		NAL Type	600-1200	240V AC 100 kA-2, 3 Pole 480V AC 50 kA-2, 3 Pole 600V AC 25 kA-2, 3 Pole	W-14 1/2 H=12 1/2 D=6 1/2
	High Interrupting 600V AC 500V DC	HHLXD6 Interchangeable Trip	800-1200	240V AC 100 kA-2, 3 Pole 480V AC 65 kA-2, 3 Pole 600V AC 50 kA-2, 3 Pole 250V DC 30 kA-2 Pole 500V DC 50 kA-3 Pole		NCL Type	600-1200	240V AC 125 kA-2, 3 Pole 480V AC 100 kA-2, 3 Pole 600V AC 65 kA-2, 3 Pole	
	Current Limiting ^③ 600V AC 500V DC	CLND6 Type	900-1200	240V AC 200 kA-3 Pole 480V AC 100 kA-3 Pole 600V AC 65 kA-3 Pole 250V DC 30 kA-2 Pole 500V DC 50 kA-3 Pole	W-9 H=16 D=6 1/2	Not Available			
	Standard Interrupting 600V AC	Sika Trip SND6	800-1200	240V AC 65 kA-3 Pole 480V AC 50 kA-3 Pole 600V AC 25 kA-3 Pole		Not Available			
	High Interrupting 600V AC	Sika Trip SHND6	800-1200	240V AC 100 kA-3 Pole 480V AC 65 kA-3 Pole 600V AC 50 kA-3 Pole		UL Type	600-1200	240V AC 125 kA-3 Pole 480V AC 100 kA-3 Pole 600V AC 65 kA-3 Pole	W-14 1/2 H=12 1/2 D=6 1/2
	Current Limiting 600V AC	Sika Trip SCLND6	900-1200	240V AC 200 kA-3 Pole 480V AC 100 kA-3 Pole 600V AC 65 kA-3 Pole		Not Available			

WESTINGHOUSE				GENERAL ELECTRIC				CUTLER-HAMMER			
LDB Interchangeable Type	320-600	240V AC 65 kA-2.3 Pole 480V AC 30 kA-2.3 Pole 600V AC 25 kA-2.3 Pole 250V DC 10 kA-2.3 Pole	W=8 1/4 H=10 1/2 D=4 1/2	TJK6 Interchangeable Type	250-600	240V AC 42 kA-2.3 Pole 480V AC 30 kA-2.3 Pole 600V AC 22 kA-2.3 Pole 250V DC 10 kA-2.3 Pole 500V DC 20 kA-3 Pole	W=8 1/4 H=10 1/2 D=3 3/8	LS-E Type LS-E Interchangeable Type	250-600	240V AC 65 kA-3 Pole 480V AC 35 kA-3 Pole 600V AC 25 kA-3 Pole 250V DC 10 kA-3 Pole	W=8 1/4 H=10 1/2 D=3 3/8
HLD Interchangeable Type	250-600	240V AC 100 kA-2.3 Pole 480V AC 65 kA-2.3 Pole 600V AC 35 kA-2.3 Pole 250V DC 20 kA-2.3 Pole		THUK6 Interchangeable Type	250-600	240V AC 65 kA-2.3 Pole 480V AC 35 kA-2.3 Pole 600V AC 25 kA-2.3 Pole 250V DC 10 kA-2.3 Pole		LH-E Interchangeable Type	250-600	240V AC 100 kA-3 Pole 480V AC 65 kA-3 Pole 600V AC 35 kA-3 Pole 250V DC 10 kA-3 Pole	
Current-Limiting LDC Interchangeable Type	320-600	240V AC 200 kA-2.3 Pole 480V AC 200 kA-2.3 Pole 600V AC 50 kA-2.3 Pole 250V DC 25 kA-2.3 Pole		Not Available	Not Available	Not Available		LL-E Type Current-Limiting	250-600	240V AC 200 kA-3 Pole 480V AC 150 kA-3 Pole 600V AC 100 kA-3 Pole 250V DC 50 kA-3 Pole	
Not Available				Not Available				Not Available			
Solid State LD	600	240V AC 65 kA-3 Pole 480V AC 35 kA-3 Pole 600V AC 25 kA-3 Pole	W=8 1/4 H=10 1/2 D=4 1/2	Solid State THUV	150-600	240V AC 65 kA-3 Pole 480V AC 35 kA-3 Pole 600V AC 25 kA-3 Pole	W=8 1/4 H=10 1/2 D=3 3/8	Not Available			
Solid State HLD	600	240V AC 100 kA-3 Pole 480V AC 65 kA-3 Pole 600V AC 35 kA-3 Pole		Solid State TJLV	150-600	240V AC 100 kA-3 Pole 480V AC 65 kA-3 Pole 600V AC 30 kA-3 Pole		Not Available			
Solid State LDC		240V AC 200 kA-3 Pole 480V AC 100 kA-3 Pole 600V AC 50 kA-3 Pole		Not Available				Not Available			
ML Interchangeable Type	175-800	240V AC 42 kA-2.3 Pole 480V AC 30 kA-2.3 Pole 600V AC 22 kA-2.3 Pole 250V DC 20 kA-2.3 Pole	W=8 1/4 H=10 1/2 D=4 1/2	TKM6 Interchangeable Type	300-800	240V AC 42 kA-2.3 Pole 480V AC 30 kA-2.3 Pole 600V AC 22 kA-2.3 Pole 250V DC 10 kA-2.3 Pole 500V DC 20 kA-3 Pole	W=8 1/4 H=10 1/2 D=5 1/2	NS Type	350-800	240V AC 42 kA-2.3 Pole 480V AC 30 kA-2.3 Pole 600V AC 22 kA-2.3 Pole 250V DC 10 kA-3 Pole (30-600DNI)	W=8 1/4 H=10 1/2 D=5 1/2
IRJA Interchangeable Type	125-800	240V AC 65 kA-2.3 Pole 480V AC 35 kA-2.3 Pole 600V AC 25 kA-2.3 Pole 250V DC 20 kA-2.3 Pole		THKJ6 Interchangeable Type	300-800	240V AC 65 kA-2.3 Pole 480V AC 35 kA-2.3 Pole 600V AC 25 kA-2.3 Pole 250V DC 10 kA-2.3 Pole 500V DC 10 kA-3 Pole		NH Type	350-800	240V AC 65 kA-3 Pole 480V AC 35 kA-3 Pole 600V AC 25 kA-2.3 Pole 250V DC 10 kA-3 Pole (50-600DNI)	
Not Available				Not Available				Not Available			
Solid State ND	600-800	240V AC 65 kA-3 Pole 480V AC 50 kA-3 Pole 600V AC 25 kA-3 Pole	W=8 1/4 H=16 D=5 1/2	Solid State TKAV	800	240V AC 42 kA-3 Pole 480V AC 30 kA-3 Pole 600V AC 27 kA-3 Pole	W=8 1/4 H=13 1/2 D=3 1/8	Not Available			
Solid State HND	600-800	240V AC 100 kA-3 Pole 480V AC 65 kA-3 Pole 600V AC 35 kA-3 Pole		Solid State TKLV	800	240V AC 100 kA-3 Pole 480V AC 65 kA-3 Pole 600V AC 30 kA-3 Pole		Not Available			
Solid State NDC	600-800	240V AC 200 kA-3 Pole 480V AC 100 kA-3 Pole 600V AC 50 kA-3 Pole		Not Available				Not Available			
NB Interchangeable Type	700-1200	240V AC 42 kA-2.3 Pole 480V AC 30 kA-2.3 Pole 600V AC 22 kA-2.3 Pole	W=8 1/4 H=16 D=5 1/2	TKM12 Interchangeable Type	600-1200	240V AC 42 kA-2.3 Pole 480V AC 30 kA-2.3 Pole 600V AC 27 kA-2.3 Pole	W=8 1/4 H=15 1/2 D=3 3/8	NS Type	700-1200	240V AC 42 kA-3 Pole 480V AC 35 kA-3 Pole 600V AC 23 kA-3 Pole	W=8 1/4 H=16 D=5 1/2
HNB Interchangeable Type	700-1200	240V AC 65 kA-2.3 Pole 480V AC 35 kA-2.3 Pole 600V AC 25 kA-2.3 Pole		THKM12 Interchangeable Type	600-1200	240V AC 65 kA-2.3 Pole 480V AC 35 kA-2.3 Pole 600V AC 25 kA-2.3 Pole		NH Type	700-1200	240V AC 65 kA-3 Pole 480V AC 30 kA-3 Pole 600V AC 22 kA-3 Pole	
Not Available				Not Available				Not Available			
Solid State ND	600-1200	240V AC 65 kA-3 Pole 480V AC 50 kA-3 Pole 600V AC 25 kA-3 Pole	W=8 1/4 H=16 D=5 1/2	Solid State TKRV	800-1200	240V AC 42 kA-3 Pole 480V AC 30 kA-3 Pole 600V AC 25 kA-3 Pole	W=8 1/4 H=15 1/2 D=5 1/2	Not Available			
Solid State HND	600-1200	240V AC 100 kA-3 Pole 480V AC 65 kA-3 Pole 600V AC 35 kA-3 Pole		Solid State TKLV	800-1200	240V AC 100 kA-3 Pole 480V AC 65 kA-3 Pole 600V AC 30 kA-3 Pole		Not Available			
Solid State NDC	600-1200	240V AC 200 kA-3 Pole 480V AC 100 kA-3 Pole 600V AC 50 kA-3 Pole		Not Available				Not Available			

TABLE 3.27 Molded-Case Circuit Breaker Interrupting Capacities
(Continued)

SIEMENS				SQUARE D					
1600A	Standard Interrupting 600V AC 500V DC	PXD6 P1=1/2" PDE Interchangeable Trip	1200-1600	240V AC 65 kA-3 Pole 480V AC 50 kA-3 Pole 600V AC 25 kA-3 Pole 250V DC 30 kA-2 Pole 500V DC 25 kA-2 Pole	W=9 H=16 D=8 7/8"	Not Available			
	High Interrupting 600V AC 500V DC	HPXD6 P1=1/2" HPDE Interchangeable Trip	1200-1600	240V AC 100 kA-3 Pole 480V AC 65 kA-3 Pole 600V AC 50 kA-3 Pole 250V DC 30 kA-2 Pole 500V DC 50 kA-3 Pole		Not Available			
	Current Limiting 600V AC 500V DC	CPD6 P1=1/2"	1200-1600	240V AC 200 kA-3 Pole 480V AC 100 kA-3 Pole 600V AC 55 kA-3 Pole 250V DC 30 kA-2 Pole 500V DC 50 kA-3 Pole		Not Available			
	Standard Interrupting 600V AC	Slow-Stroke SPD6	1400-1600	240V AC 65 kA-3 Pole 480V AC 50 kA-3 Pole 600V AC 25 kA-3 Pole		Not Available			
2000A	High Interrupting 600V AC	Slow-Stroke SHPD6	1400-1600	240V AC 100 kA-3 Pole 480V AC 65 kA-3 Pole 600V AC 50 kA-3 Pole	W=9 H=16 D=8 7/8"	Slow-Stroke PXK	1400-1600	240V AC 125 kA-3 Pole 480V AC 100 kA-3 Pole 600V AC 65 kA-3 Pole	W=23 1/2" H=26 7/8" D=13 7/8"
	Standard Interrupting 600V AC 500V DC	RXD6 P1=1/2" RDE Interchangeable Trip	1800-2000	240V AC 65 kA-3 Pole 480V AC 50 kA-3 Pole 600V AC 25 kA-3 Pole 250V DC 30 kA-2 Pole 500V DC 25 kA-2 Pole		PAF P1=1/2" PAF,DC	600-2000	240V AC 65 kA-3 Pole 480V AC 50 kA-3 Pole 600V AC 42 kA-2.3 Pole 500V DC 25 kA-3 Pole	W=12 1/2" H=20 7/8" D=7 1/4"
	High Interrupting 600V AC 500V DC	HRXD6 P1=1/2" HRDE Interchangeable Trip	1600-2000	240V AC 100 kA-3 Pole 480V AC 65 kA-3 Pole 600V AC 50 kA-3 Pole 250V DC 30 kA-2 Pole 500V DC 50 kA-3 Pole	PHF P1=1/2"	600-2000	240V AC 125 kA-3 Pole 480V AC 100 kA-3 Pole 600V AC 65 kA-3 Pole		

1 Meets UL criteria for current limiting @ 240 VAC
 2 Meets UL criteria for current limiting @ 240 and 480 VAC
 3 Current limiting @ 240 and 480 VAC

TABLE 3.28 NEC Table 450.3 (A): Maximum Rating or Setting of
Overcurrent Protection for Transformers over 600 Volts (as a Percentage
of Transformer-Rated Current)

Location Limitations	Transformer Rated Impedance	Secondary Protection (See Note 2.)				
		Primary Protection Over 600 Volts		Over 600 Volts		600 Volts or Below
		Circuit Breaker (See Note 4.)	Fuse Rating	Circuit Breaker (See Note 4.)	Fuse Rating	Circuit Breaker or Fuse Rating
Any location	Not more than 6%	600% (See Note 1.)	300% (See Note 1.)	300% (See Note 1.)	250% (See Note 1.)	125% (See Note 1.)
	More than 6% and not more than 10%	400% (See Note 1.)	300% (See Note 1.)	250% (See Note 1.)	225% (See Note 1.)	125% (See Note 1.)
Supervised locations only (See Note 3.)	Any	300% (See Note 1.)	250% (See Note 1.)	Not required	Not required	Not required
	Not more than 6%	600%	300%	300% (See Note 5.)	250% (See Note 5.)	250% (See Note 5.)
	More than 6% and not more than 10%	400%	300%	250% (See Note 5.)	225% (See Note 5.)	250% (See Note 5.)

Notes:

- Where the required fuse rating or circuit breaker setting does not correspond to a standard rating or setting, a higher rating or setting that does not exceed the next higher standard rating or setting shall be permitted.
- Where secondary overcurrent protection is required, the secondary overcurrent device shall be permitted to consist of not more than six circuit breakers or six sets of fuses grouped in one location. Where multiple overcurrent devices are utilized, the total of all the device ratings shall not exceed the allowed value of a single overcurrent device. If both circuit breakers and fuses are used as the overcurrent device, the total of the device ratings shall not exceed that allowed for fuses.
- A supervised location is a location where conditions of maintenance and supervision ensure that only qualified persons monitor and service the transformer installation.
- Electronically actuated fuses that may be set to open at a specific current shall be set in accordance with settings for circuit breakers.
- A transformer equipped with a coordinated thermal overload protection by the manufacturer shall be permitted to have separate secondary protection omitted.

WESTINGHOUSE				GENERAL ELECTRIC				CUTLER-HAMMER	
Not Available				Not Available				Not Available	
Not Available				Not Available				Not Available	
Not Available				Not Available				Not Available	
Sole Size RID	800-1600	240V AC 125 kA-3 Pole 480V AC 65 kA-3 Pole 600V AC 50 kA-3 Pole	W=15 1/2 H=16 D=9 1/4	Sole Size TRLA	800-1600	240V AC 100 kA-3 Pole 480V AC 65 kA-3 Pole 600V AC 50 kA-3 Pole	W=12 1/2 H=17 1/2 D=8 9/16	Not Available	
Sole Size RDC	800-1600	240V AC 200 kA-3 Pole 480V AC 100 kA-3 Pole 600V AC 65 kA-3 Pole		Sole Size TRPA	600-1200	240V AC 125 kA-3 Pole 480V AC 100 kA-3 Pole 600V AC 65 kA-3 Pole		Not Available	
Not Available				Not Available				Not Available	
Not Available				Not Available				Not Available	

TABLE 3.29 U.L. 1008 Minimum Withstand Test Requirement

Automatic Transfer Switch Rating	U.L. Minimum Current Amps	U.L. Test Current Power Factor
100 Amps or less	5,000	40% to 50%
101-400 Amps	10,000	40% to 50%
401 Amps and greater	20 times rating but not less than 10,000 Amps	40% to 50% for current of 10,000 Amps. OR 25% to 30% for currents of 20,000 Amps or less. OR 20% or less for current greater than 20,000 Amps.

TABLE 3.30 Short-Circuit Test Currents—Table 55.1 of U.L. Standard 1995

Product Ratings, A				
110-120V	Single-Phase			Circuit Capacity, A
	200-208V	220-240V	254-277V	
9.8 or less	5.4 or less	4.9 or less	—	200
9.9-16.0	5.5-8.8	5.0-8.0	6.65 or less	1000
16.1-34.0	8.9-18.6	8.1-17.0	—	2000
34.1-80.0	18.7-44.0	17.1-40.0	—	3500
Over 80.0	Over 44.0	Over 40.0	Over 6.65	5000
3-Phase				
200-208V	220-240V	440-480V	550-600V	Circuit Capacity, A
	2.12 or less	2.0 or less	—	
2.13-3.7	2.1-3.5	1.8 or less	1.4 or less	1000
3.8-9.5	3.6-9.0	—	—	2000
9.6-23.3	9.1-22.0	—	—	3500
Over 23.3	Over 22.0	Over 1.8	Over 1.4	5000

*Table 55.1 of U.L. Standard 1995.

FIGURE 3.27 Current-limiting effect of fuses.

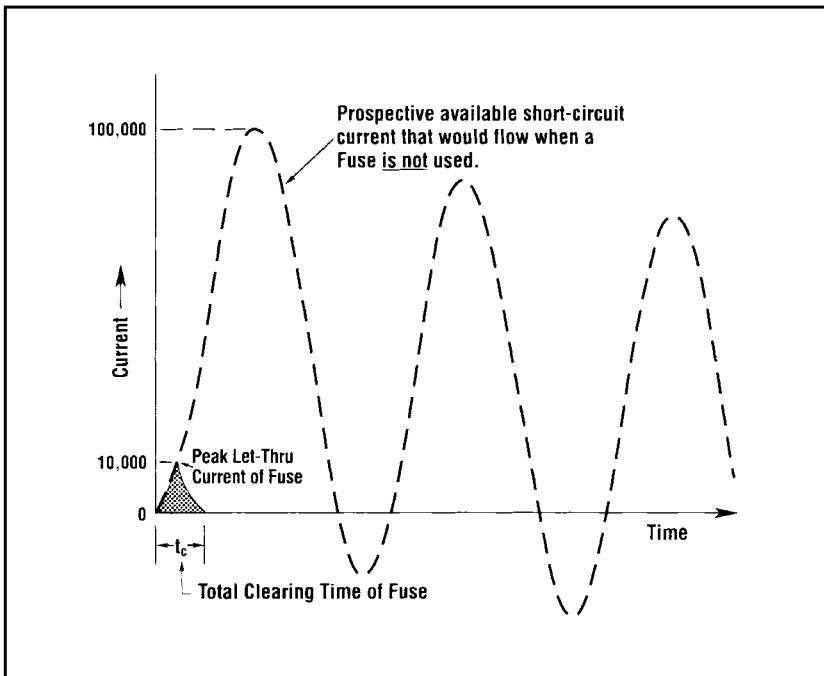
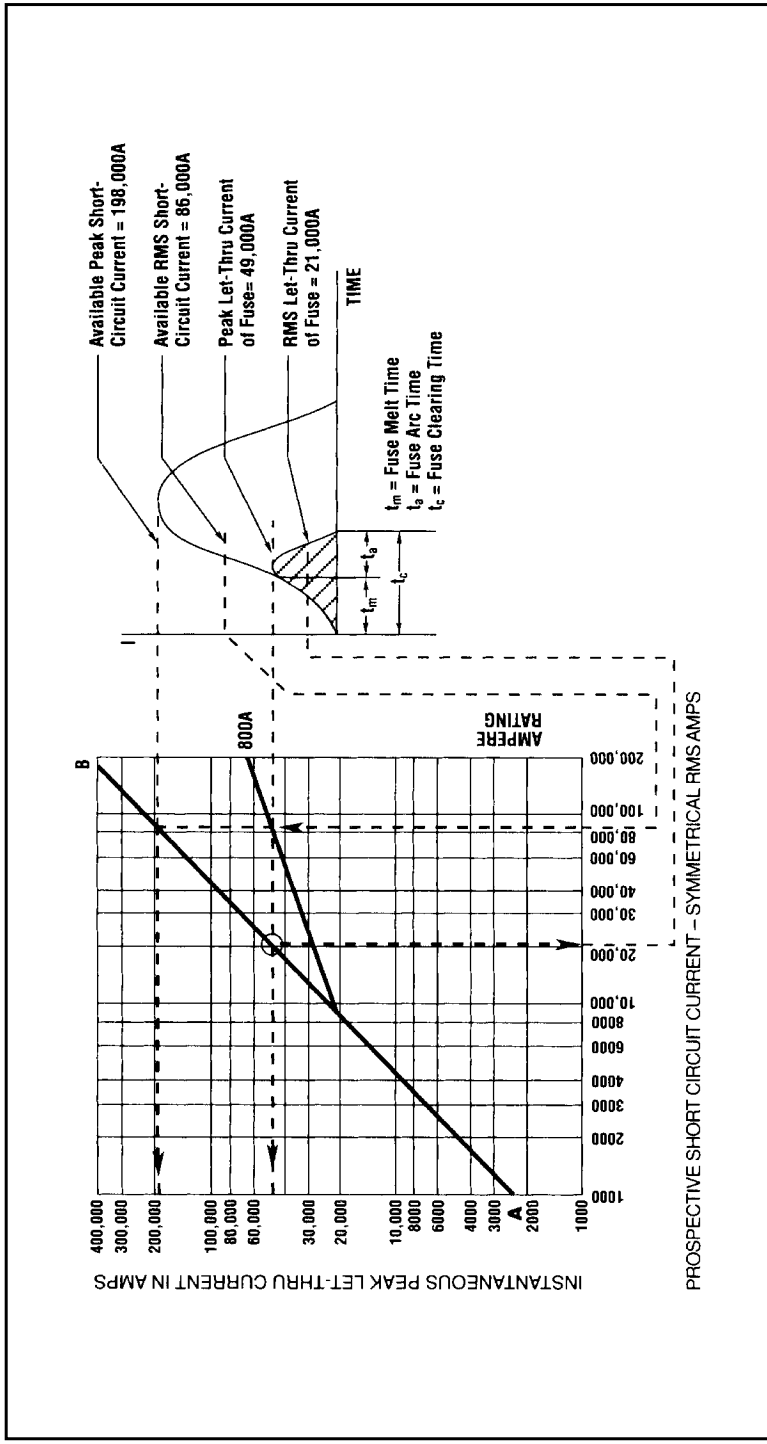

FIGURE 3.28 Analysis of a current-limiting fuse.



LET-THRU DATA PERTINENT TO EQUIPMENT WITHSTAND

Prior to using the Fuse Let-Thru Charts, it must be determined what let-thru data is pertinent to equipment withstand ratings.

Equipment withstand ratings can be describe as: How much fault current can the equipment handle, and for how long? Based on standards currently available, the most important data that can be obtained from the Fuse Let-Thru Charts and their physical effects are the following:

- *Peak let-thru current:* mechanical forces
- *Apparent prospective rms symmetrical let-thru current:* heating effect

Figure 3.29 is a typical example showing the short-circuit current available to an 800-A circuit, an 800-A Bussmann Low-Peak current-limiting time-delay fuse, and the let-thru data of interest.

HOW TO USE THE LET-THRU CHARTS

Using the example given in Figure 3.29, one can determine the pertinent let-thru data for the Bussmann KRP-C800SP ampere Low-Peak fuse. The Let-Thru Chart pertaining to the 800-A Low-Peak fuse is illustrated in Figure 3.30.

Determine the Peak Let-Thru Current

- Step 1:* Enter the chart on the Prospective Short-Circuit current scale at 86,000 A and proceed vertically until the 800-A fuse curve is intersected.
- Step 2:* Follow horizontally until the Instantaneous Peak Let-Thru Current scale is intersected.
- Step 3:* Read the Peak Let-Thru Current as 49,000 A. (If a fuse had not been used, the peak current would have been 198,000 A.)

Determine the Apparent Prospective rms Symmetrical Let-Thru Current

- Step 1:* Enter the chart on the Prospective Short-Circuit Current scale at 86,000 A and proceed vertically until the 800-A fuse curve is intersected.
- Step 2:* Follow horizontally until line A-B is intersected.
- Step 3:* Proceed vertically down to the Prospective Short-Circuit Current.
- Step 4:* Read the Apparent Prospective RMS Symmetrical Let-Thru Current as 21,000 A. (The RMS Symmetrical Let-Thru Current would be 86,000 A if there were no fuse in the circuit.)

FIGURE 3.29 800-A Low-Peak® current-limiting time-delay fuse and associated let-thru data.

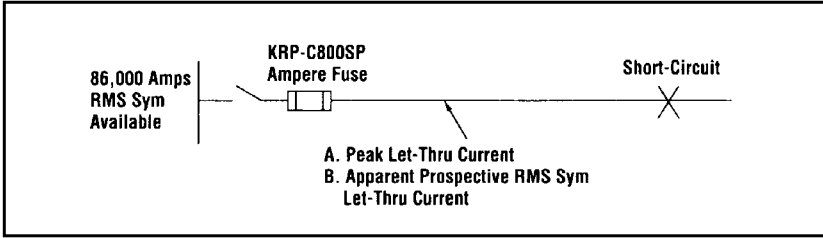
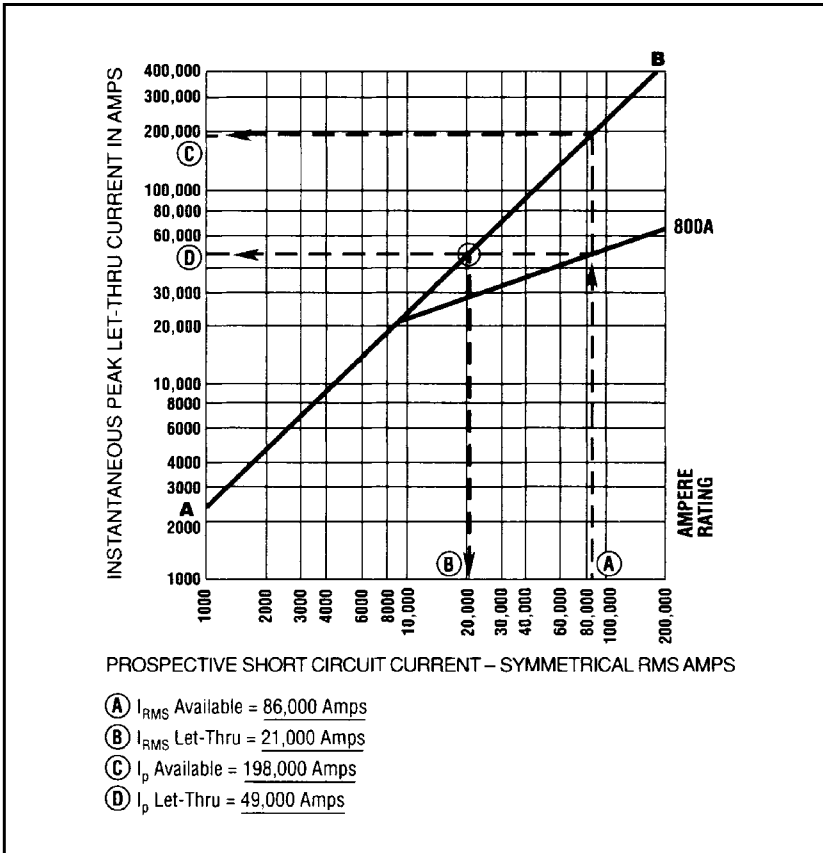

FIGURE 3.30 Current-limitation curves-Bussmann Low-Peak® time-delay fuse KRP-C800SP.



Refer to different fuse manufacturers' current limitation characteristics for applications of different fuse types and sizes under various circuit conditions.

3.6 TRANSFORMER ELECTRICAL CHARACTERISTICS

Introduction

Transformers are a critical part of electrical distribution systems because they are most often used to change voltage levels. This affects voltage, current (both load and fault current levels), and system capacity. They can also be used to isolate, suppress harmonics, derive neutrals through a zig-zag grounding arrangement, and reregulate voltage. Their electrical characteristics are as follows (see Tables 3.31–3.34 and Figure 3.31).

Auto Zig-Zag Grounding Transformers

Three single-phase transformers can be connected in an autotransformer arrangement for developing a neutral from a three-phase, three-wire supply (phase-shifting). For proper overcurrent protection, refer to NEC Article 450.4. Figure 3.32 shows the one line and wiring diagrams for this arrangement.

Table 3.35 shows the nameplate kVA for each transformer, number of transformers required, three-phase kVA rating, and maximum continuous amp load per phase (@ 277 V) for a primary input of 480 V, three-phase, three-wire, to a secondary output of 480Y/277 V, three-phase, four-wire.

Buck-Boost/Autotransformers

INTRODUCTION

Buck-boost transformers are small, single-phase transformers designed to reduce (buck) or raise (boost) line voltage from 5 to 20 percent. The most common example is boosting 208 V to 230 V, usually to operate a 230-V motor, such as an air-conditioner compressor, from a 208-V supply line.

Buck-boosts are a standard type of single-phase distribution transformer, with primary voltages of 120, 240, or 480 V and secondaries typically of 12, 16, 24, 32, or 48 V. They are available in sizes ranging from 50 VA to 10 kVA.

Buck-boost transformers are insulating-type transformers. When their primary and secondary lead wires are connected together electrically in a recommended bucking or boosting connection, however, they are in all respects an autotransformer.

TABLE 3.31 Transformer Full-Load Current, Three-Phase, Self-Cooled Ratings

Voltage, Line-to-Line													
kVA	208	240	480	600	2,400	4,160	7,200	12,000	12,470	13,200	13,800	22,900	34,400
30	83.3	72.2	36.1	28.9	7.22	4.16	2.41	1.44	1.39	1.31	1.26	0.75	0.50
45	125	108	54.1	43.3	10.8	6.25	3.61	2.17	2.08	1.97	1.88	1.13	0.76
75	208	180	90.2	72.2	18.0	10.4	6.01	3.61	3.47	3.28	3.14	1.89	1.26
112½	312	271	135	108	27.1	15.6	9.02	5.41	5.21	4.92	4.71	2.84	1.89
150	416	361	180	144	36.1	20.8	12.0	7.22	6.94	6.56	6.28	3.78	2.52
225	625	541	271	217	54.1	31.2	18.0	10.8	10.4	9.84	9.41	5.67	3.78
300	833	722	361	289	72.2	41.6	24.1	14.4	13.9	13.1	12.6	7.56	5.04
500	1,388	1,203	601	481	120	69.4	40.1	24.1	23.1	21.9	20.9	12.6	8.39
750	2,082	1,804	902	722	180	104	60.1	36.1	34.7	32.8	31.4	18.9	12.6
1,000	2,776	2,406	1,203	962	241	139	80.2	48.1	46.3	43.7	41.8	25.2	16.8
1,500	4,164	3,608	1,804	1,443	361	208	120	72.2	69.4	65.6	62.8	37.8	25.2
2,000	4,811	2,406	1,925	481	278	160	96.2	92.6	87.5	83.7	50.4	33.6
2,500	3,007	2,406	601	347	200	120	116	109	105	63.0	42.0
3,000	3,609	2,887	722	416	241	144	139	131	126	75.6	50.4
3,750	4,511	3,608	902	520	301	180	174	164	157	94.5	62.9
5,000	4,811	1,203	694	401	241	231	219	209	126	83.9
7,500	1,804	1,041	601	361	347	328	314	189	126
10,000	2,406	1,388	802	481	463	437	418	252	168

TABLE 3.32 Typical Impedances, Three-Phase Transformers

kVA	Liquid-Filled	
	Network	Padmount
37.5
45
50
75	3.4
112.5	3.2
150	2.4
225	3.3
300	5.00	3.4
500	5.00	4.6
750	5.00	5.75
1000	5.00	5.75
1500	7.00	5.75
2000	7.00	5.75
2500	7.00	5.75
3000	6.50
3750	6.50
5000	6.50

① Values are typical. For guaranteed values, refer to transformer manufacturer.

APPLICATIONS

Electrical and electronic equipment is designed to operate on standard supply voltage. When the supply voltage is constantly too low or too high (usually more than ± 5 percent), the equipment fails to operate at maximum efficiency. A buck-and-boost transformer is a simple and economical means of correcting such an off-standard voltage.

Buck-boost transformers are commonly used for boosting 208 V to 230 or 240 V and vice versa for commercial and industrial air-conditioning systems, boosting 110 V to 120 V and 240 V to 277 V for lighting systems, and voltage correction for heating systems and induction motors of all types.

Buck-boost transformers can also be used to power low-voltage circuits for control, lighting, and other applications requiring 12, 16, 24, 32, or 48 V. The unit is connected as an insulating transformer and the nameplate kVA rating is the transformer's capacity.

OPERATION AND CONSTRUCTION

Buck-boost transformers have four windings to make them versatile. Their two primary and two secondary windings can be connected eight different ways to provide a multitude of voltage and kVA outputs. They cannot be used to stabilize voltage, however, because the output voltage

TABLE 3.33 Approximate Transformer Loss and Impedance Data

15 kV Class Oil Liquid-Filled Transformers						
65°C Rise						
kVA	No Load Watts Loss	Full Load Watts Loss	%Z	%R	%X	X/R
112.5	550	2470	5.00	1.71	4.70	2.75
150	545	3360	5.00	1.88	4.63	2.47
225	650	4800	5.00	1.84	4.65	2.52
300	950	5000	5.00	1.35	4.81	3.57
500	1200	8700	5.00	1.50	4.77	3.18
750	1600	12160	5.75	1.41	5.57	3.96
1000	1800	15100	5.75	1.33	5.59	4.21
1500	3000	19800	5.75	1.12	5.64	5.04
2000	4000	22600	5.75	0.93	5.67	6.10
2500	4500	26000	5.75	0.86	5.69	6.61

15 kV Class Primary – Dry-Type Transformers Class H						
150°C Rise						
kVA	No Load Watts Loss	Full Load Watts Loss	%Z	%R	%X	X/R
300	1600	10200	4.50	2.87	3.47	1.21
500	1900	15200	5.75	2.66	5.10	1.92
750	2700	21200	5.75	2.47	5.19	2.11
1000	3400	25000	5.75	2.16	5.33	2.47
1500	4500	32600	5.75	1.87	5.44	2.90
2000	5700	44200	5.75	1.93	5.42	2.81
2500	7300	50800	5.75	1.74	5.48	3.15
80°C Rise						
300	1800	7600	4.50	1.93	4.06	2.10
500	2300	9500	5.75	1.44	5.57	3.87
750	3400	13000	5.75	1.28	5.61	4.38
1000	4200	13500	5.75	0.93	5.67	6.10
1500	5900	19000	5.75	0.87	5.68	6.51
2000	6900	20000	5.75	0.66	5.71	8.72
2500	7200	21200	5.75	0.56	5.72	10.22

is a function of the input voltage; i.e., if the input voltage varies, the output voltage will also vary by the same percentage.

LOAD DATA

The fact that a buck-boost transformer can operate a kVA load many times larger than the kVA rating on its nameplate may seem paradoxical, and consequently, sometimes causes confusion in sizing.

TABLE 3.33 Approximate Transformer Loss and Impedance Data (*Continued*)**600-Volt Primary Class Dry-Type Transformers**

150°C Rise						
kVA	No Load Watts Loss	Full Load Watts Loss	%Z	%R	%X	X/R
3	33	231	7.93	6.60	4.40	0.67
6	58	255	3.70	3.28	1.71	0.52
9	77	252	3.42	1.94	2.81	1.45
15	150	875	5.20	4.83	1.92	0.40
30	200	1600	5.60	4.67	3.10	0.66
45	300	1900	4.50	3.56	2.76	0.78
75	400	3000	4.90	3.47	3.46	1.00
112.5	500	4900	5.90	3.91	4.42	1.13
150	600	6700	6.20	4.07	4.68	1.15
225	700	8600	6.40	3.51	5.35	1.52
300	800	10200	7.10	3.13	6.37	2.03
500	1700	9000	5.50	1.46	5.30	3.63
750	2200	11700	6.30	1.27	6.17	4.87
1000	2800	13600	6.50	1.08	6.41	5.93

600-Volt Primary Class Dry-Type Transformers

115°C Rise						
kVA	No Load Watts Loss	Full Load Watts Loss	%Z	%R	%X	X/R
15	150	700	5.20	3.67	3.69	1.01
30	200	1500	4.60	4.33	1.54	0.36
45	300	1700	3.70	3.11	2.00	0.64
75	400	2300	4.60	2.53	3.84	1.52
112.5	500	3100	6.50	2.31	6.08	2.63
150	600	5900	6.20	3.53	5.09	1.44
225	700	6000	7.20	2.36	6.80	2.89
300	800	6600	6.30	1.93	6.00	3.10
500	1700	6800	5.50	1.02	5.40	5.30
750	1500	9000	4.10	1.00	3.98	3.98

600-Volt Primary Class Dry-Type Transformers

80°C Rise						
kVA	No Load Watts Loss	Full Load Watts Loss	%Z	%R	%X	X/R
15	200	500	2.30	2.00	1.14	0.57
30	300	975	2.90	2.25	1.83	0.81
45	300	1100	2.90	1.78	2.29	1.29
75	400	1950	3.70	2.07	3.07	1.49
112.5	600	3400	4.30	2.49	3.51	1.41
150	700	3250	4.10	1.70	3.73	2.19
225	800	4000	5.30	1.42	5.11	3.59
300	1300	4300	3.30	1.00	3.14	3.14
500	2200	5300	4.50	0.62	4.46	7.19

TABLE 3.34 Transformer Primary (480-Volt, Three-Phase, Delta) and Secondary (208Y/120-Volt, Three-Phase, Four-Wire) Overcurrent Protection, Conductors and Grounding

THREE PHASE TRANSFORMER SCHEDULE					
XFMR NUMBER	480V. PRIMARY (Δ) 3PH, 3W.		120/208V. SECONDARY (Y) 3PH, 4W.		KVA RATING
	O.C.P.D.	PRIMARY FEEDER	O.C.P.D.	SECONDARY FEEDER	
T15	30A	3#10, 1#10 G., 3/4" C.	50A	3#6, 1#6 N., 1#6 G., 1-1/4" C.	15
T30	60A	3#6, 1#10 G., 1" C.	100A	3#1, 1#1 N., 1#6 G., 1-1/2" C.	30
T45	100A	3#4, 1#8 G., 1-1/4" C.	150A	3#1/0, 1#1/0 N., 1#6 G., 2" C.	45
T75	150A	3#1, 1#6 G., 1-1/2" C.	225A	3#250KCMIL, 1#250KCMIL N., 1#2 G., 2-1/2" C.	75
T112.5	200A	3#2/0, 1#6 G., 2" C.	400A	3#500KCMIL, 1#500KCMIL N., 1#1/0 G., 3-1/2" C.	112.5
T150	250A	3#4/0, 1#4 G., 2-1/2" C.	500A	2 SETS OF 3#250KCMIL, 1#250KCMIL N., 1#1/0 G., 2-1/2" C. EACH	150
T225	400A	3#500KCMIL, 1#3 G., 3" C.	800A	2 SETS OF 3#500KCMIL, 1#500KCMIL N., 1#2/0 G., 3-1/2" C. EACH	225
T300	600A	2 SETS OF 3#4/0, 1#1 G., 2-1/2" C. EACH	1000A	3 SETS OF 3#400KCMIL, 1#400KCMIL N., 1#3/0 G., 3-1/2" C. EACH	300
T500	800A	2 SETS OF 3#500KCMIL, 1#1/0 G., 3" C. EACH	1600A	4 SETS OF 3#600KCMIL, 1#600KCMIL N., 1#3/0 G., 3-1/2" C. EACH	500

TRANSFORMER NOTES:

- T1. CONNECT GROUNDING ELECTRODE CONDUCTOR TO THE NEAREST OF THE FOLLOWING:
 - 1. AN EFFECTIVELY GROUNDED STRUCTURAL METAL MEMBER OF THE STRUCTURE.
 - 2. AN EFFECTIVELY GROUNDED METAL WATER PIPE WITHIN 5FT. FROM THE POINT OF ENTRANCE INTO THE BUILDING.
- T2. REFER TO DISTRIBUTION TRANSFORMER GROUNDING DETAIL.
- T3. CONDUCTOR SIZES ARE BASED ON COPPER CONDUCTORS (TYPE THHN/THWN FOR CONDUCTOR SIZES SMALLER THAN #3 AWG AND TYPE XHHW FOR CONDUCTOR SIZES #3 AWG AND LARGER).

K - RATED, THREE PHASE TRANSFORMER SCHEDULE

K - RATED, THREE PHASE TRANSFORMER SCHEDULE					
XFMR NUMBER	480V. PRIMARY (Δ) 3PH, 3W.		120/208V. SECONDARY (Y) 3PH, 4W.		KVA RATING
	O.C.P.D.	PRIMARY FEEDER	O.C.P.D.	SECONDARY FEEDER	
TK15	30A	3#10, 1#10 G., 3/4" C.	50A	3#6, 1#1 N., 1#6 G., 1#6 I.G., 1-1/4" C.	15
TK30	60A	3#6, 1#10 G., 1" C.	100A	3#1, 1#3/0 N., 1#6 G., 1#6 I.G., 2" C.	30
TK45	100A	3#4, 1#8 G., 1-1/4" C.	150A	3#1/0, 2#1/0 N., 1#6 G., 1#6 I.G., 2" C.	45
TK75	150A	3#1, 1#6 G., 1-1/2" C.	225A	3#250KCMIL, 2#250KCMIL N., 1#2 G., 1#4 I.G., 3" C.	75
TK112.5	200A	3#2/0, 1#6 G., 2" C.	400A	3#500KCMIL, 2#500KCMIL N., 1#1/0 G., 1#3 I.G., 4" C.	112.5
TK150	250A	3#4/0, 1#4 G., 2-1/2" C.	500A	2 SETS OF 3#250KCMIL, 2#250KCMIL N., 1#1/0 G., 1#2 I.G., 3" C. EACH	150
TK225	400A	3#500KCMIL, 1#3 G., 3" C.	800A	2 SETS OF 3#500KCMIL, 2#500KCMIL N., 1#2/0 G., 1#1/0 I.G., 4" C. EACH	225
TK300	600A	2 SETS OF 3#4/0, 1#1 G., 2-1/2" C. EACH	1000A	3 SETS OF 3#400KCMIL, 2#400KCMIL N., 1#3/0 G., 1#2/0 I.G., 3-1/2" C. EACH	300

K-RATED TRANSFORMER NOTES:

- TK1. UNLESS OTHERWISE INDICATED ALL TRANSFORMERS HAVE A "K" RATING OF 13, REFER TO SPECIFICATIONS.
- TK2. CONNECT GROUNDING ELECTRODE CONDUCTOR TO THE NEAREST OF THE FOLLOWING:
 - 1. AN EFFECTIVELY GROUNDED STRUCTURAL METAL MEMBER OF THE STRUCTURE.
 - 2. AN EFFECTIVELY GROUNDED METAL WATER PIPE WITHIN 5FEET FROM THE POINT OF ENTRANCE INTO THE BUILDING.
- TK3. NEUTRAL CONDUCTOR IS RATED 200 PERCENT FOR HARMONIC CURRENTS.
- TK4. REFER TO DISTRIBUTION TRANSFORMER GROUNDING DETAIL.
- TK5. CONDUCTOR SIZES ARE BASED ON COPPER CONDUCTORS (TYPE THHN/THWN FOR CONDUCTOR SIZES SMALLER THAN #3 AWG AND TYPE XHHW FOR CONDUCTOR SIZES #3 AWG AND LARGER).

TABLE 3.34 Transformer Primary (480-Volt, Three-Phase, Delta) and Secondary (208Y/120-Volt, Three-Phase, Four-Wire) Overcurrent Protection, Conductors and Grounding (*Continued*)

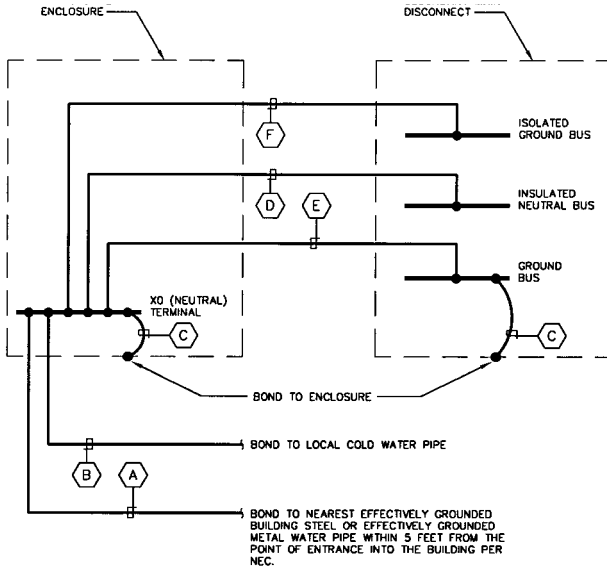

- A** GROUNDING ELECTRODE CONDUCTOR (REFER TO 'GROUND & CONDUIT' COLUMN IN TRANSFORMER SCHEDULES FOR CONDUCTOR AND CONDUIT SIZE).
- B** BONDING JUMPER (REFER TO 'GROUND & CONDUIT' COLUMN IN TRANSFORMER SCHEDULES FOR CONDUCTOR AND CONDUIT SIZE).
- C** BONDING JUMPER (REFER TO GROUND CONDUCTOR SIZE IN 'SECONDARY FEEDER' COLUMN IN TRANSFORMER SCHEDULES).
- D** GROUNDED (NEUTRAL) CONDUCTOR (REFER TO 'SECONDARY FEEDER' COLUMN FOR CONDUCTOR SIZE)
- E** MAIN BONDING JUMPER CONDUCTOR (REFER TO GROUND CONDUCTOR SIZE IN 'SECONDARY FEEDER' COLUMN IN TRANSFORMER SCHEDULES). MAIN BONDING JUMPER CONDUCTOR TO BE RUN IN EACH CONDUIT CONTAINING PHASE CONDUCTORS BETWEEN TRANSFORMER AND MAIN SECONDARY DISCONNECT.
- F** ISOLATED EQUIPMENT GROUND CONDUCTOR (REFER TO 'SECONDARY FEEDER' COLUMN IN TRANSFORMER SCHEDULES FOR ISOLATED GROUND CONDUCTOR SIZE).

DISTRIBUTION TRANSFORMER GROUNDING DETAIL

N. T. S.

NOTES:

ISOLATED GROUND BUS AND ASSOCIATED ISOLATED EQUIPMENT GROUND CONDUCTOR SHALL BE PROVIDED BETWEEN K-RATED TRANSFORMERS AND SECONDARY MAIN DISCONNECT SERVING ELECTRONIC GRADE PANELBOARDS WITH INTEGRAL TVSS.

FIGURE 3.31 Electrical connection diagrams.

**CONNECTION DIAGRAMS
For Transformers**

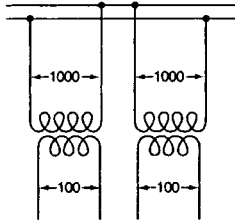

Single-phase transformers on a single phase system.

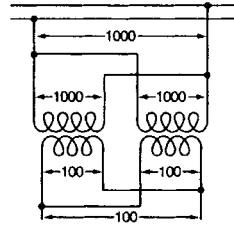

Single-phase transformers, secondaries in parallel.

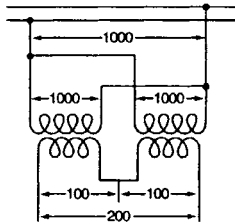

Single-phase transformers secondaries in series.

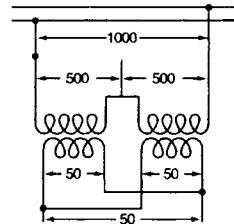

Single-phase transformers primaries in series, secondaries in parallel.

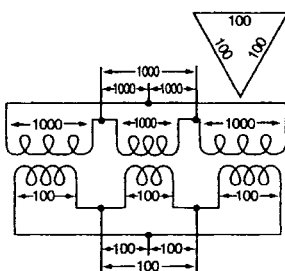

Three single-phase transformers connected delta-delta to a three-phase system.

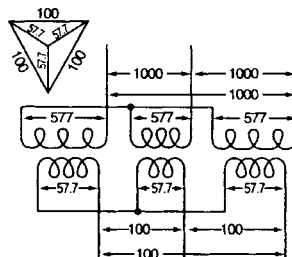

Three single-phase transformers connected star-star to a three-phase system.

FIGURE 3.31 Electrical connection diagrams. (Continued)

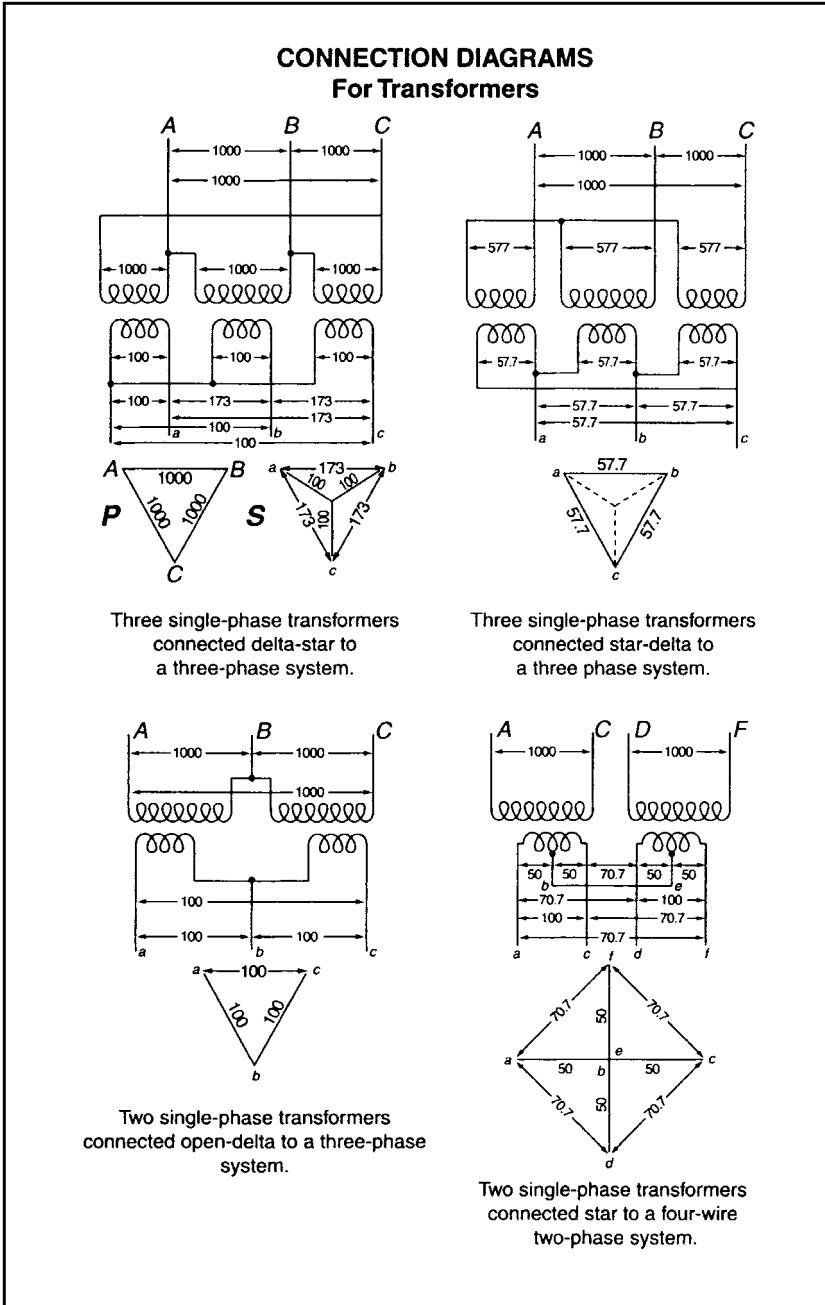
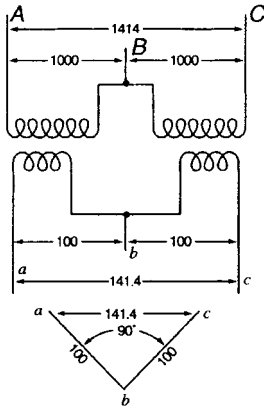
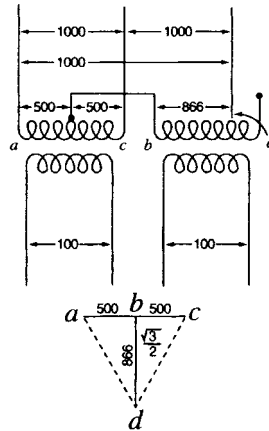

FIGURE 3.31 Electrical connection diagrams. (Continued)

**CONNECTION DIAGRAMS
For Transformers**



Two single-phase transformers connected to a three-wire two-phase system.



Two single-phase transformers connected T to a three-phase two-phase system. Scott Connection.

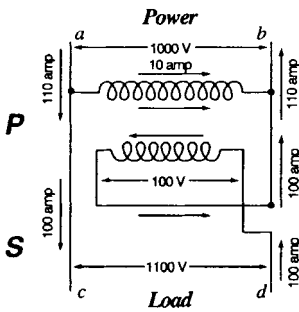

Single phase transformer used as a booster.

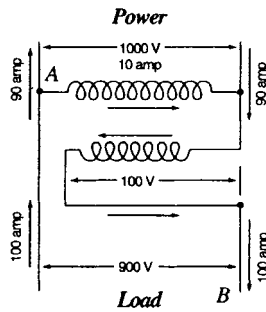

Single phase transformer connected to lower the E.M.F.

FIGURE 3.32 Auto zig-zag grounding transformers for deriving a neutral—schematic and wiring diagram.

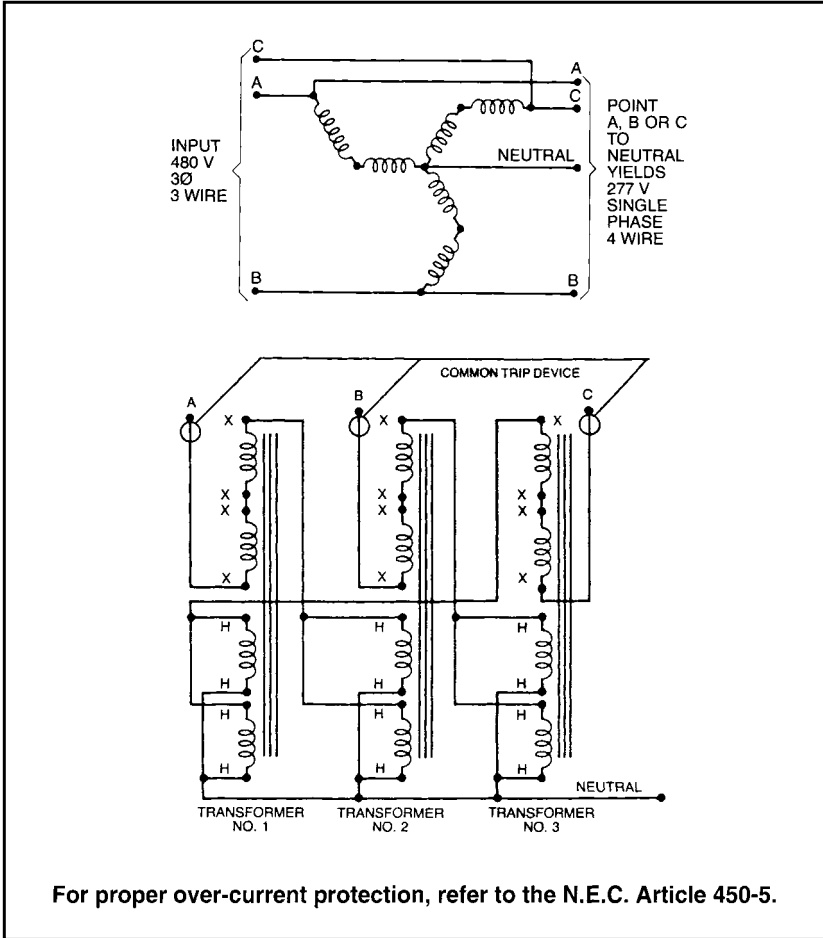

To cite an example, a buck-boost transformer has a nameplate rating of 1 kVA, but when it's connected as an autotransformer boosting 208 V to 230 V, its kVA capacity increases to 9.58 kVA. The key to understanding the operation of buck-boost transformers lies in the fact that the secondary windings are the only parts of the transformer that do the work of transforming voltage and current. In the example given, only 22 V are being transformed (boosted): $208\text{ V} + 22\text{ V} = 230\text{ V}$. This 22-V transformation is carried out by the secondary windings, which are designed to operate at a maximum current of 41.67 A (determined by wire size of windings).

TABLE 3.35 Auto Zig-Zag Grounding Transformer Ratings

3Ø, 3 WIRE		*50/60 Hz			3Ø, 4 WIRE	
Use 3 Pieces of Type No.	Available In	Nameplate KVA For Each Tmtr.	No. of Tmtr. Required	Three Phase KVA	Max. Continuous Amp. Load Per Phase (277 Volts)	
T-2-53010-S	No Taps Only	1.0	3	10.8	12.50	
T-2-53011-S	No Taps Only	1.5	3	15.6	18.75	
T-2-53012-S	No Taps Only	2.0	3	20.7	25.00	
T-2-53013-4S	Taps & No Taps	3.0	3	31.2	37.50	
T-2-53014-4S	Taps & No Taps	5.0	3	51.9	62.50	
T-2-53515-3S	With Taps Only	7.5	3	78.0	93.50	
T-2-53516-3S	With Taps Only	10.0	3	103.8	125.00	
T-2-53517-3S	With Taps Only	15.0	3	156.0	187.50	
T-2-53518-3S	With Taps Only	25.0	3	259.5	312.00	
T-1-53019-3S	With Taps Only	37.5	3	390.0	468.00	
T-1-53020-3S	With Taps Only	50.0	3	519.0	625.00	
T-1-53021-3S	With Taps Only	75.0	3	780.0	935.00	
T-1-53022-3S	With Taps Only	100.0	3	1038.0	1250.00	
T-1-53023-3S	With Taps Only	167.0	3	1734.0	2085.00	

Connection diagram (using 3 pieces of 1 phase, 60 hertz transformers connected zig-zag auto) for developing a neutral (4th wire) from a 3 phase 3 wire supply
 *Applicable for the above connection only

Maximum secondary amps = nameplate kVA × 1000/secondary volts
 Maximum secondary amps = 1.0 kVA × 1000/24 V = 41.67 A

Because the transformer has been autoconnected in such a fashion that the 22-V secondary voltage is added to the 208-V primary voltage, it produces a 230-V output.

The autotransformer kVA is calculated thus:

$$\begin{aligned} \text{kVA} &= \text{output volts} \times \text{secondary amps}/1000 \\ \text{kVA} &= 230 \text{ V} \times 41.67 \text{ A}/1000 = 9.58 \text{ kVA} \end{aligned}$$

THREE-PHASE

To this point, we have only discussed single-phase applications. Buck-boost transformers can be used on three-phase systems. Two or three units are used to buck or boost three-phase voltage. The number of units to be used in a three-phase installation depends on the number of wires in the supply line. If the three-phase supply is four-wire Y, use three buck-boost transformers. If the three-phase supply is three-wire Y (neutral not available), use two buck-boost transformers.

A three-phase wye buck-boost transformer connection should be used only on a four-wire source of supply. A delta-to-wye connection does not provide adequate current capacity to accommodate unbalanced currents flowing in the neutral wire of the four-wire circuit.

A closed delta buck-boost autotransformer connection requires more transformer kilovolt-amperes than a wye or open delta connection, and phase shifting occurs on the output. Consequently, the closed delta connection is more expensive and electrically inferior to other three-phase connections.

The do's and don'ts of three-phase connections are summarized in Table 3.36.

TABLE 3.36 Buck-Boost Transformer Three-Phase Connection Summary

INPUT (SUPPLY SYSTEM)	DESIRED OUTPUT CONNECTION	
DELTA 3 wire	WYE 3 or 4 wire	DO NOT USE
OPEN DELTA 3 wire	WYE 3 or 4 wire	DO NOT USE
WYE 3 or 4 wire	CLOSED DELTA 3 wire	DO NOT USE
WYE 4 wire	WYE 3 or 4 wire	OK
WYE 3 or 4 wire	OPEN DELTA 3 wire	OK
CLOSED DELTA 3 wire	OPEN DELTA 3 wire	OK

SOUND LEVELS, LIFE EXPECTANCY, AND COST

The sound levels and life expectancy of buck-boost transformers are the same as any other insulating transformer. However, an autoconnected buck-boost transformer will be quieter than an insulating transformer capable of handling the same load. The insulating unit would have to be physically larger than the buck-boost transformer, and smaller transformers are quieter than larger ones. Using a similar rationale, for the most common buck-boost applications, the dollar savings are generally in the order of 75 percent compared with the use of an insulating-type distribution transformer for the same application.

DIAGRAMS

Figure 3.33 shows typical connection diagrams for single-phase buck-boost transformers used for low-voltage power supply applications.

Figures 3.34 and 3.35 show typical connection diagrams for single-phase and three-phase, respectively, buck-boost transformers connected in an autotransformer arrangement.

FIGURE 3.33 Wiring diagrams for low-voltage single-phase buck-boost transformers.

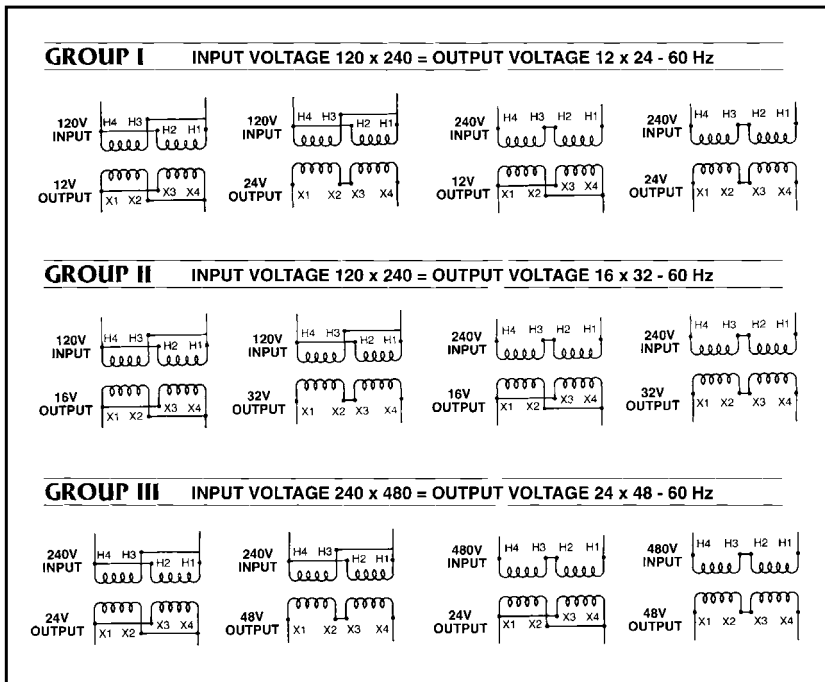

FIGURE 3.34 Connection diagrams for buck-boost transformers in autotransformer arrangement for single-phase system.

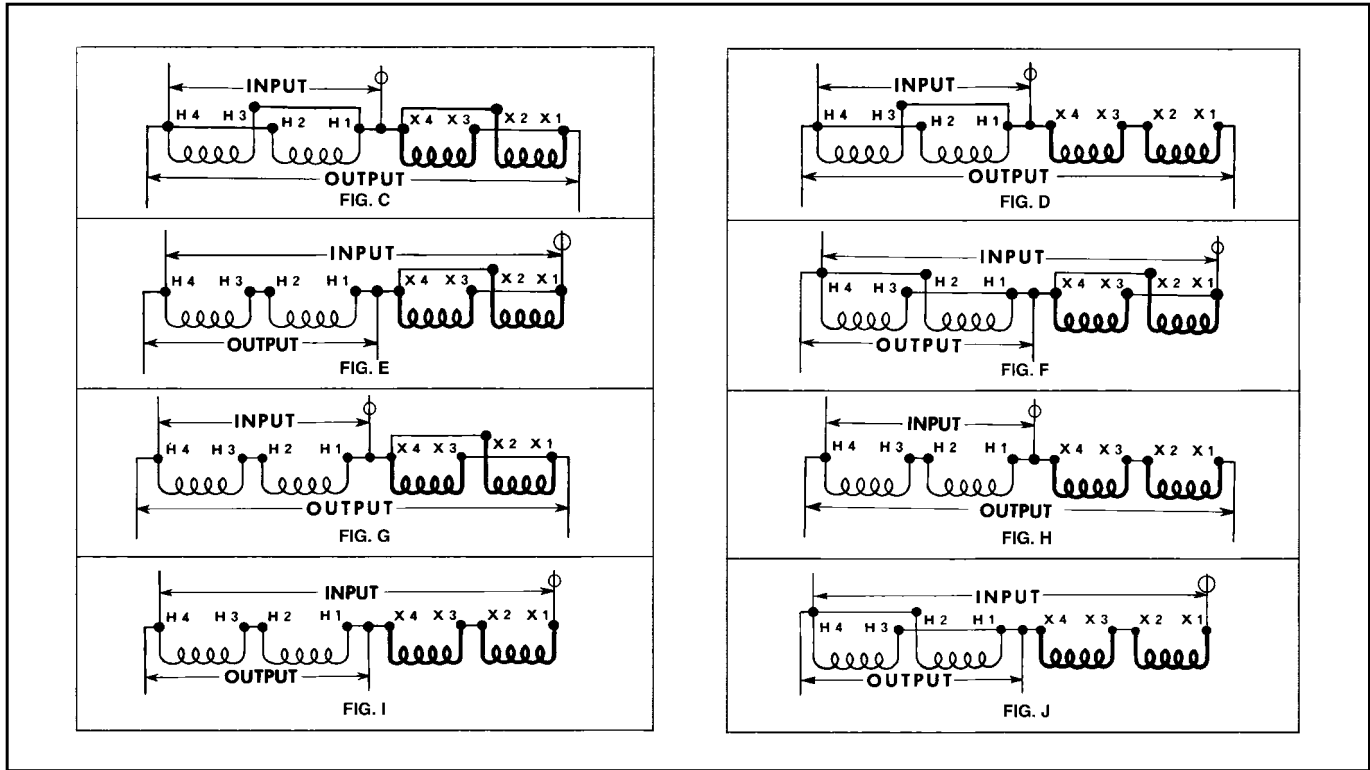

FIGURE 3.35 Connection diagrams for buck-boost transformers in autotransformer arrangement for three-phase system.

The symbol **O** used in these connection diagrams indicates where to field-install the over-current protective device, typically a fuse or circuit breaker.

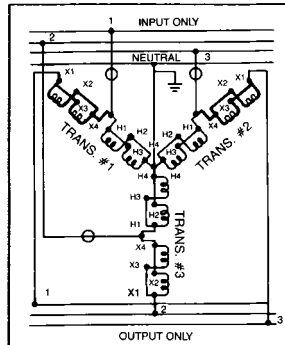

FIG. AA WYE

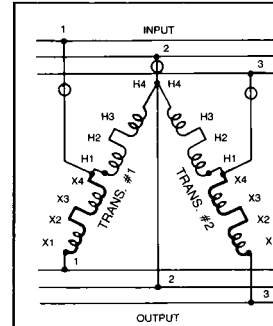

FIG. BB OPEN DELTA

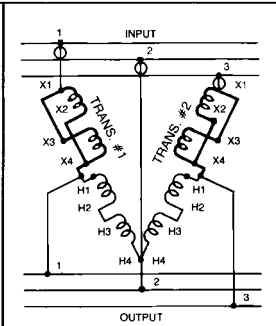

FIG. CC OPEN DELTA

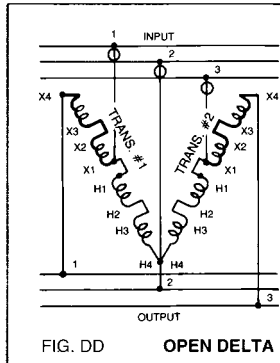

FIG. DD OPEN DELTA

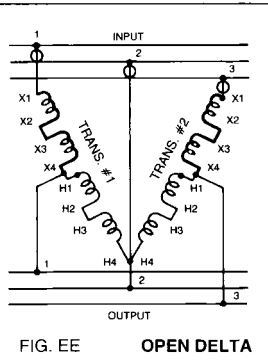

FIG. EE OPEN DELTA

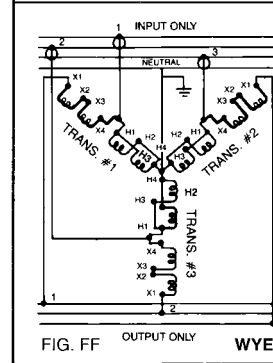

FIG. FF WYE

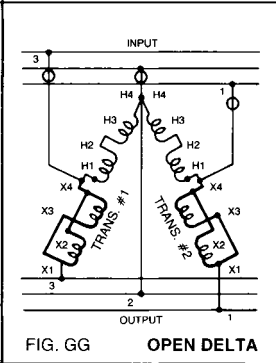

FIG. GG OPEN DELTA

Do not use connections other than those shown above.

3.7 TRANSFORMER THERMAL AND SOUND CHARACTERISTICS

In addition to transformer electrical characteristics, their thermal and sound level characteristics are very important. Thermal characteristics are determined by industry standards (UL/ANSI 1561-1987) and are generally only of concern to the electrical design professional. Sound levels, on the other hand, are of concern to everyone, especially the architect and occupants of the building. Electrical design professionals must be sensitive and aware of the sound levels of electrical equipment and their impact on the occupants of the building and exercise appropriate measures to mitigate their effects. These could include remotely locating the equipment, sound attenuation techniques, and/or structural isolation. To assist you in evaluating these considerations, Figure 3.36 shows the thermal characteristics of dry-type distribution transformers, and Tables 3.37 and 3.38, respectively, show the maximum average sound levels of dry-type and liquid-filled transformers and typical ambient sound levels.

k-Rated Transformers

Transformers used for supplying the nonsinusoidal high harmonic (>5 percent) content loads that are increasingly prevalent must be designed and listed for these loads. ANSI C57.110-1986, "Recommended Practice for Establishing Transformer Capability When Supplying Non-Sinusoidal Load Currents," provides a method for calculating the heating effect in a transformer when high harmonic currents are present. This method generates a number called the *k*-factor, which is a multiplier that

FIGURE 3.36 Transformer insulation system temperature ratings.

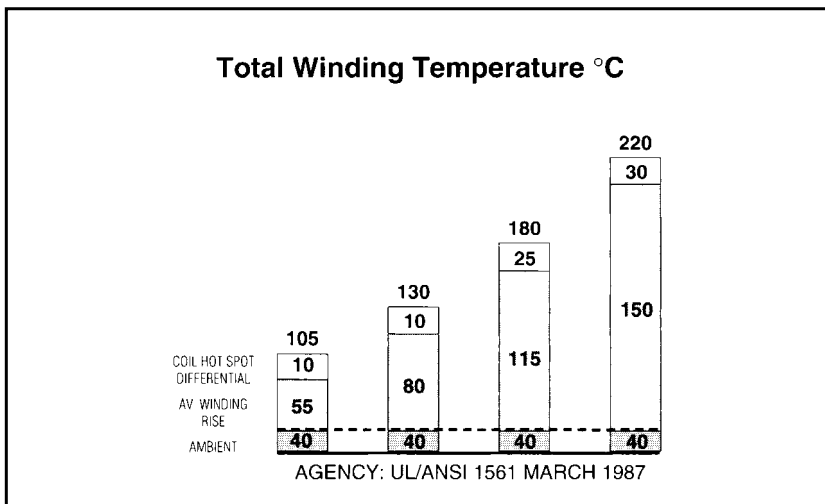

TABLE 3.37 Typical Building Sound Levels

Radio, Recording and TV Studios	25-30 db
Theatres and Music Rooms	30-35
Hospitals, Auditoriums and Churches	35-40
Classrooms and Lecture Rooms	35-40
Apartments and Hotels	35-45
Private Offices and Conference Rooms	40-45
Stores	45-55
Residence (Radio, TV Off) and Small Offices	53
Medium Office (3 to 10 Desks)	58
Residence (Radio, TV On)	60
Large Store (5 or More Clerks)	61
Factory Office	61
Large Office	64
Average Factory	70
Average Street	80

related eddy current losses in the transformer core due to harmonics to increased transformer heating. Transformer manufacturers use this information to design transformer core/coil and insulation systems that are more tolerant of the higher internal heating load than a standard design. Simply put, a *k*-rated transformer can tolerate approximately *k* times more internal heat than a similar, standard-design transformer (for example, a *k*-4 transformer can handle approximately four times the internal heating load of a similar ANSI standard nonharmonic rated transformer with no life expectancy reduction).

TABLE 3.38 Maximum Average Sound Levels for Transformers

kVA	Dry-Type		Liquid-Filled	
	Self-Cooled Rating (AA)	Forced-Air Cooling (FA)	Self-Cooled Rating (OA)	Forced-Air Cooling (FA)
0-50	50
51-150	55
151-300	58	67	55	67
301-500	60	67	56	67
501-700	62	67	57	67
701-1000	64	67	58	67
1001-1500	65	68	60	67
1501-2000	66	69	61	67
2001-2500	68	71	62	67
2501-3000	70	71	63	67
3001-4000	71	73	64	67
4001-5000	72	74	65	67
5001-6000	73	75	66	68
6001-7500	..	76	67	69
7501-10000	..	76	68	70

The *k*-rating of a transformer addresses only increased internal heating. It does not address mitigation of the harmonic content of the transformer load.

3.8 MOTOR FEEDERS AND STARTERS

Introduction

Motors comprise a significant portion of a building's electrical system loads. They are needed to power fans and pumps for basic mechanical building infrastructure, such as heating, ventilation, air-conditioning, plumbing, fire protection, elevators, and escalators. They are also needed to power equipment endemic to the occupancy, such as commercial kitchen equipment in an institutional facility, CT and MRI scanners in a hospital, and process equipment such as conveyors and machinery in an industrial plant or stone quarry. Consequently, designing motor-circuit feeders is very much in the mainstream of the electrical design professional's daily work. To save time in this process, the following information is provided.

Sizing Motor-Circuit Feeders and Their Overcurrent Protection

- I. For AC single-phase motors, polyphase motors other than wound-rotor (synchronous and induction other than Code E):^{1,2}
 1. Feeder wire size is 125 percent of motor full-load (FL) current *minimum*.
 2. Feeder breaker (thermal-magnetic fixed-trip type) is 250 percent of FL current *maximum*.
 3. Feeder breaker (instantaneous magnetic-only type) is 800 percent of FL current *maximum*.
 4. Feeder fuse (dual-element time-delay type) is 175 percent of FL current *maximum*.
 5. Feeder fuse (NEC non-time-delay type) is 300 percent of FL current *maximum*.
- II. For wound-rotor motors:
 1. Feeder wire size is 125 percent of motor FL current *minimum*.
 2. Feeder breaker (thermal-magnetic fixed-trip type) is 150 percent of FL current *maximum*.
 3. Feeder breaker (instantaneous magnetic-only type) is 800 percent of FL current *maximum*.

¹ Synchronous motors of the low-torque, low-speed type (usually 450 rpm or lower), such as those used to drive reciprocating compressors, pumps, and so forth, that start unloaded, do not require a fuse rating or circuit breaker setting in excess of 200 percent of full-load current.

² For Code Letter E induction motors, everything is the same as above except if an instantaneous magnetic-only-type circuit breaker is used, it shall have a *maximum* setting of 1100 percent.

4. Feeder fuse (dual-element time-delay type) is 150 percent of FL current *maximum*.
5. Feeder fuse (NEC non-time-delay type) is 150 percent of FL current *maximum*.

III. *For hermetic motors (special case):* Hermetic motors are actually a combination consisting of a compressor and motor, both of which are enclosed in the same housing, with no external shaft or shaft seals, the motor operating in the refrigerant; thus, their characteristics are different than standard induction motors. Calculating their feeder size and overcurrent protection is based on their nameplate branch-circuit selection current (BCSC) or their rated-load current (RLC), whichever is greater. The BCSC is always equal to or greater than the RLC. Hence, the following:

1. Feeder wire size is 125 percent of BCSC/RLC *maximum*.
2. Feeder breaker (thermal-magnetic fixed-trip type) is between 175 and 225 percent of BCSC/RLC *maximum*.
3. Feeder breaker (instantaneous magnetic-only type) is 800 percent of BCSC/RLC *maximum*.
4. Feeder fuse (dual-element time-delay type) is between 175 and 225 percent of BCSC/RLC *maximum*.
5. Feeder fuse (NEC non-time-delay type) is NOT RECOMMENDED—DO NOT USE.

IV. *Direct-current (constant-voltage) motors:*

1. Feeder wire size is 125 percent of motor FL current *maximum*.
2. Feeder breaker (thermal-magnetic fixed-trip type) is 150 percent of FL current *maximum*.
3. Feeder breaker (instantaneous magnetic-only type) is 250 percent of FL current *maximum*.
4. Feeder fuse (dual-element time-delay type) is 150 percent of FL current *maximum*.
5. Feeder fuse (NEC non-time-delay type) is 150 percent of FL current *maximum*.

V. *For multiple motors on one feeder:* First, size the feeder and overcurrent protection for the largest motor and add the full-load current of the remaining motors to size the overall feeder and overcurrent protection.

VI. *Application tips:*

1. Refer to NEC Articles 430 and 440 for further details on sizing motor feeders and overcurrent protection.
2. For elevator motors, always try to get the full-load current, because the nameplate horsepower on many machines is about 10 to 25 percent below the actual rating.
3. For packaged-type evaporative condensers with many small fans nominally rated 1 hp (for example), be sure to get the full-load current, because these are really equivalent to about

2 hp (for example) each, and feeders sized on nominal horsepower ratings will be inadequate. Remember to size the feeder and overcurrent protection as a multiple-motor load. Also refer to NEC Article 440.

4. Note that *maximum* and *minimum* have precise meanings: feeder sizes shall not be less than the calculated minimum within 3 or 4 percent (e.g., 30 A-rated No. 10 wire is okay for a 31-A load), and breaker sizes shall not be more than the maximum indicated. In general, for larger motor sizes, the overcurrent protection needed decreases considerably from the maximum limit.
5. In sizing nonfused disconnects for motors, use the horsepower rating table in the manufacturer's catalog or realize that in general, a nonfused disconnect switch should be rated the same as a switch fused with a dual-element time-delay fuse.
6. When sizing feeders for tape drives in mainframe data centers, it is usually necessary to oversize both the overcurrent protection and the feeder to accommodate the long acceleration time characteristic of this equipment.
7. Today's highly energy-efficient motors are characterized by low losses and high inrush currents, thus requiring overcurrent protection sized at or near the maximum limit prescribed by the NEC when these motors are used.
8. For NEC Locked-Rotor Indicating Code Letters, refer to Table 3.39 [NEC Table 430.7(B)].

TABLE 3.39 NEC Table 430.7(B): Locked-Rotor Indicating Code Letters

Code Letter	Kilovolt-Amperes per Horsepower with Locked Rotor		
A	0	—	3.14
B	3.15	—	3.54
C	3.55	—	3.99
D	4.0	—	4.49
E	4.5	—	4.99
F	5.0	—	5.59
G	5.6	—	6.29
H	6.3	—	7.09
J	7.1	—	7.99
K	8.0	—	8.99
L	9.0	—	9.99
M	10.0	—	11.19
N	11.2	—	12.49
P	12.5	—	13.99
R	14.0	—	15.99
S	16.0	—	17.99
T	18.0	—	19.99
U	20.0	—	22.39
V	22.4	—	and up

Motor Circuit Data Sheets

The following motor circuit data sheets provide recommended design standards for branch-circuit protection and wiring of squirrel cage induction motors of the sizes and voltages most frequently encountered in commercial, institutional, and industrial facilities. Experience has shown that most facilities of this type use copper wire, and use No. 12 AWG wire and $\frac{3}{4}$ -in conduit as minimum sizes for power distribution. These standards are reflected in the tables that follow. Refer also to the notes to Tables 3.40–3.44 for assumptions and other criteria used.

Motor Starter Characteristics (for Squirrel Cage Motors)

There are fundamentally two types of motor starters: full-voltage (both reversing and nonreversing) and reduced-voltage. In the information that follows, their characteristics and selection criteria are briefly summarized.

FULL-VOLTAGE STARTERS

A squirrel cage motor draws high starting current (inrush) and produces high starting torque when started at full voltage. Although these values differ for different motor designs, for a typical NEMA design B motor, the inrush will be approximately 600 percent of the motor full-load amperage (FLA) rating and the starting torque will be approximately 150 percent of full-load torque at full voltage. High-current inrush and starting torque can cause problems in the electrical and mechanical systems and may even cause damage to the utilization equipment or materials being processed.

REDUCED-VOLTAGE STARTERS

When a motor is started at reduced voltage, the current at the motor terminals is reduced in direct proportion to the voltage reduction, whereas the torque is reduced by the square of the voltage reduction. If the “typical” NEMA B motor is started at 70 percent of line voltage, the starting current would be 70 percent of the full-voltage value (i.e., $0.70 \times 600\% = 420\%$ FLA). The torque would then be $(0.70)^2$ or 49 percent of the normal starting torque (i.e., $0.49 \times 150\% = 74\%$ full-load torque). Therefore, reduced-voltage starting provides an effective means of reducing both inrush current and starting torque.

If the motor has a high inertia or if the motor rating is marginal for the applied load, reducing the starting torque may prevent the motor from reaching full speed before the thermal overloads trip. Applications that require high starting torque should be reviewed carefully to determine if reduced-voltage starting is suitable. As a rule, motors with a

TABLE 3.40 460-Volt 3-Phase Motor Branch Circuit Requirements for 480-Volt System

460 VOLT 3 PHASE MOTOR BRANCH CIRCUIT REQUIREMENTS FOR 480 VOLT SYSTEM							
MOTOR HP	MOTOR FLA	OCPD (3 POLE)		SAFETY SWITCH		STARTER NEMA SIZE	BRANCH CIRCUIT REQUIREMENTS
		C/B	FUSE*	SWITCH SIZE	FUSE SIZE		
1/2	1.1	15	15	30	15	00	3/4"C WITH 3#12, 1#12G
3/4	1.6	15	15	30	15	00	3/4"C WITH 3#12, 1#12G
1	2.1	15	15	30	15	00	3/4"C WITH 3#12, 1#12G
1-1/2	3	15	15	30	15	00	3/4"C WITH 3#12, 1#12G
2	3.4	15	15	30	15	0	3/4"C WITH 3#12, 1#12G
3	4.8	15	15	30	15	0	3/4"C WITH 3#12, 1#12G
5	7.6	20	15	30	15	1	3/4"C WITH 3#12, 1#12G
7-1/2	11	25	20	30	20	1	3/4"C WITH 3#10, 1#10G***
10	14	35	25	30	25	2	3/4"C WITH 3#10, 1#10G
15	21	50	35	60	35	2	3/4"C WITH 3#10, 1#10G
20	27	70	45	60	45	2	3/4"C WITH 3#8, 1#8G****
25	34	80	60	60	60	3	1"C WITH 3#6, 1#8G*
30	40	100	70	100	70	3	1"C WITH 3#6, 1#8G
40	52	125	90	100	90	3	1-1/4"C WITH 3#4, 1#6G*
50	65	150	110	200	110	4	1-1/4"C WITH 3#3, 1#6G
60	77	200	125	200	125	4	2"C WITH 3#1, 1#6G
75	96	250	170	200	170	4	2"C WITH 3#1/0, 1#4G*
100	124	300	200	200	200	5	2"C WITH 3#3/0, 1#4G*
125	156	400	275	400	275	5	2-1/2"C WITH 3#4/0, 1#3G*
150	180	450	300	400	300	5	3"C WITH 3#300MCM, 1#2G**
200	240	600	400	400	400	5	3-1/2"C WITH 3#500MCM, 1#1G**
250	302	750	500	600	500	6	2 SETS OF 2-1/2"C WITH 3#4/0, 1#1/0G**
300	361	900	600	600	600	6	2 SETS OF 3"C WITH 3#300MCM, 1#2/0G EACH**
350	414	1000	700	800	700	--	2 SETS OF 3"C WITH 3#350MCM, 1#2/0G EACH*
400	477	1200	800	800	800	--	2 SETS OF 3-1/2"C WITH 3#500MCM, 1#3/0G EACH**
450	515	1200	900	1200	900	--	2 SETS OF 4"C WITH 3#600MCM, 1#3/0G EACH*

* WHEN FUSES ARE USED AS THE OCPD, THE GROUND CONDUCTOR SIZE MAY BE REDUCED BY ONE AWG SIZE.

** WHEN FUSES ARE USED AS THE OCPD, THE GROUND CONDUCTOR SIZE MAY BE REDUCED BY TWO AWG SIZES.

*** WHEN FUSES ARE USED AS THE OCPD, THE LINE AND GROUND CONDUCTOR SIZES MAY BE REDUCED BY ONE AWG SIZE.

**** IF THE RACEWAY IS SCHEDULE 80 PVC, THE CONDUIT SIZE MUST BE INCREASED BY ONE TRADE SIZE.

GENERAL NOTES:

1. FUSE SIZES ARE BASED ON DUAL ELEMENT FUSES.
2. CIRCUIT BREAKER SIZES ARE BASED ON MOLDED CASE INVERSE TIME BREAKERS.
3. CONDUIT SIZES ARE BASED ON MOST RESTRICTIVE CONDUIT SIZE AND MATERIAL UNLESS OTHERWISE NOTED.
4. CONDUCTOR SIZES ARE BASED ON COPPER THHN/THWN (#2 AWG AND SMALLER) AND XHHW (#3 AWG AND LARGER).

TABLE 3.41 200-Volt 3-Phase Motor Branch Circuit Requirements for 208-Volt System

200 VOLT 3 PHASE MOTOR BRANCH CIRCUIT REQUIREMENTS FOR 208 VOLT SYSTEM							
MOTOR HP	MOTOR FLA	OCPD (3 POLE)		SAFETY SWITCH		STARTER	BRANCH CIRCUIT REQUIREMENTS
		C/B	FUSE*	SWITCH SIZE	FUSE SIZE	NEMA SIZE	
1/2	2.5	15	15	30	15	00	3/4"C WITH 3#12, 1#12G
3/4	3.7	15	15	30	15	00	3/4"C WITH 3#12, 1#12G
1	4.8	15	15	30	15	00	3/4"C WITH 3#12, 1#12G
1-1/2	6.9	15	15	30	15	0	3/4"C WITH 3#12, 1#12G
2	7.8	20	15	30	15	0	3/4"C WITH 3#12, 1#12G
3	11	25	20	30	20	1	3/4"C WITH 3#10, 1#10G***
5	17.5	40	30	30	30	1	3/4"C WITH 3#10, 1#10G
7-1/2	25.3	60	40	60	40	2	3/4"C WITH 3#8, 1#10G
10	32.2	80	60	60	60	3	3/4"C WITH 3#8, 1#8G****
15	48.3	125	80	100	80	3	1-1/4"C WITH 3#4, 1#6G*
20	62.1	150	100	100	100	3	1-1/4"C WITH 3#3, 1#6G*
25	78.2	200	125	200	125	4	2"C WITH 3#1, 1#6G
30	92	225	150	200	150	4	2"C WITH 3#1/0, 1#4G*
40	120	300	200	200	200	5	2-1/2"C WITH 3#3/0, 1#4G*
50	150	375	250	400	250	5	2-1/2"C WITH 3#4/0, 1#3G*
60	177	400	300	400	300	5	3"C WITH 3#300MCM, 1#3G*
75	221	500	400	400	400	6	3"C WITH 3#400MCM, 1#2G*/****
100	285	700	500	600	500	6	2 SETS OF 2-1/2"C WITH 3#4/0, 1#1/0G**
125	359	900	600	600	600	6	2 SETS OF 3"C WITH 3#300MCM, 1#2/0G**
150	414	1000	700	800	700	6	2 SETS OF 3"C WITH 3#350MCM, 1#2/0G*

* WHEN FUSES ARE USED AS THE OCPD, THE GROUND CONDUCTOR SIZE MAY BE REDUCED BY ONE AWG SIZE.

** WHEN FUSES ARE USED AS THE OCPD, THE GROUND CONDUCTOR SIZE MAY BE REDUCED BY TWO AWG SIZES.

*** WHEN FUSES ARE USED AS THE OCPD, THE LINE AND GROUND CONDUCTOR SIZES MAY BE REDUCED BY ONE AWG SIZE.

**** IF THE RACEWAY IS SCHEDULE 80 PVC, THE CONDUIT SIZE MUST BE INCREASED BY ONE TRADE SIZE.

GENERAL NOTES:

1. FUSE SIZES ARE BASED ON DUAL ELEMENT FUSES.
2. CIRCUIT BREAKER SIZES ARE BASED ON MOLDED CASE INVERSE TIME BREAKERS.
3. CONDUIT SIZES ARE BASED ON MOST RESTRICTIVE CONDUIT SIZE AND MATERIAL UNLESS OTHERWISE NOTED.
4. CONDUCTOR SIZES ARE BASED ON COPPER THHN/THWN (#2 AWG AND SMALLER) AND XHHW (#3 AWG AND LARGER).



TABLE 3.42 115-Volt Single-Phase Motor Branch Circuit Requirements for 120-Volt System

115 VOLT SINGLE PHASE MOTOR BRANCH CIRCUIT REQUIREMENTS FOR 120 VOLT SYSTEM							
MOTOR HP	MOTOR FLA	OCPD (1 POLE)		SAFETY SWITCH		STARTER NEMA SIZE	BRANCH CIRCUIT REQUIREMENTS
		C/B	FUSE*	SWITCH SIZE	FUSE SIZE		
1/6	4.4	15	15	30	15	00	3/4" C WITH 2#12, 1#12G
1/4	5.8	15	15	30	15	0	3/4" C WITH 2#12, 1#12G
1/3	7.2	20	15	30	15	0	3/4" C WITH 2#12, 1#12G
1/2	9.8	25	20	30	20	0	3/4" C WITH 2#10, 1#10G***
3/4	13.8	35	25	30	25	0	3/4" C WITH 2#10, 1#10G
1	16	40	30	30	30	1	3/4" C WITH 2#10, 1#10G
1-1/2	20	50	35	60	35	1	3/4" C WITH 2#10, 1#10G
2	24	60	40	60	40	1	3/4" C WITH 2#8, 1#10G

*** WHEN FUSES ARE USED AS THE OCPD, THE LINE AND GROUND CONDUCTOR SIZES MAY BE REDUCED BY ONE AWG SIZE.

GENERAL NOTES:

1. FUSE SIZES ARE BASED ON DUAL ELEMENT FUSES.
2. CIRCUIT BREAKER SIZES ARE BASED ON MOLDED CASE INVERSE TIME BREAKERS.
3. CONDUIT SIZES ARE BASED ON MOST RESTRICTIVE CONDUIT SIZE AND MATERIAL UNLESS OTHERWISE NOTED.
4. CONDUCTOR SIZES ARE BASED ON COPPER THHN/THWN (#2 AWG AND SMALLER) AND XHHW (#3 AWG AND LARGER).

TABLE 3.43 200-Volt Single-Phase Motor Branch Circuit Requirements for 208-Volt System

200 VOLT SINGLE PHASE MOTOR BRANCH CIRCUIT REQUIREMENTS FOR 208 VOLTS SYSTEM							
MOTOR HP	MOTOR FLA	OCPD (2 POLE)		SAFETY SWITCH		STARTER NEMA SIZE	BRANCH CIRCUIT REQUIREMENTS
		C/B	FUSE*	SWITCH SIZE	FUSE SIZE		
1/6	2.5	15	15	30	15	00	3/4"C WITH 2#12, 1#12G
1/4	3.3	15	15	30	15	00	3/4"C WITH 2#12, 1#12G
1/3	4.1	15	15	30	15	00	3/4"C WITH 2#12, 1#12G
1/2	5.6	15	15	30	15	00	3/4"C WITH 2#12, 1#12G
3/4	7.9	20	15	30	15	00	3/4"C WITH 2#12, 1#12G
1	9.2	25	20	30	20	0	3/4"C WITH 2#10, 1#10G***
1-1/2	11.5	30	20	30	20	0	3/4"C WITH 2#10, 1#10G***
2	13.8	35	25	30	25	1	3/4"C WITH 2#10, 1#10G
3	19.6	50	35	60	35	2	3/4"C WITH 2#10, 1#10G
5	32.2	80	60	60	60	2	3/4"C WITH 2#8, 1#8G*
7.5	46	110	80	100	80	3	1-1/4"C WITH 2#4, 1#6G*
10	57.5	150	100	100	100	3	1-1/4"C WITH 2#3, 1#6G*

* WHEN FUSES ARE USED AS THE OCPD, THE GROUND CONDUCTOR SIZE MAY BE REDUCED BY ONE AWG SIZE.

*** WHEN FUSES ARE USED AS THE OCPD, THE LINE AND GROUND CONDUCTOR SIZES MAY BE REDUCED BY ONE AWG SIZE.

GENERAL NOTES:

1. FUSE SIZES ARE BASED ON DUAL ELEMENT FUSES.
2. CIRCUIT BREAKER SIZES ARE BASED ON MOLDED CASE INVERSE TIME BREAKERS.
3. CONDUIT SIZES ARE BASED ON MOST RESTRICTIVE CONDUIT SIZE AND MATERIAL UNLESS OTHERWISE NOTED.
4. CONDUCTOR SIZES ARE BASED ON COPPER THHN/THWN (#2 AWG AND SMALLER) AND XHHW (#3 AWG AND LARGER).

TABLE 3.44 230-Volt Single-Phase Motor Branch Circuit Requirements for 240-Volt System

230-VOLT SINGLE PHASE MOTOR BRANCH CIRCUIT REQUIREMENTS FOR 240 VOLT SYSTEM									
MOTOR HP	MOTOR FLA		OCB (2 POLE)		SAFETY SWITCH		STARTER NEMA SIZE	BRANCH CIRCUIT REQUIREMENTS	
	C/B	FUSE*	SWITCH SIZE†	FUSE SIZE	SWITCH SIZE†	FUSE SIZE			
1/6	2.2	15	15	30	15	15	00	3/4" C WITH 2#12, 1#12G	
1/4	2.9	15	15	30	15	15	00	3/4" C WITH 2#12, 1#12G	
1/3	3.6	15	15	30	15	15	00	3/4" C WITH 2#12, 1#12G	
1/2	4.9	15	15	30	15	15	00	3/4" C WITH 2#12, 1#12G	
3/4	6.9	20	15	30	15	15	00	3/4" C WITH 2#12, 1#12G	
1	8	20	15	30	15	15	0	3/4" C WITH 2#12, 1#12G	
1-1/2	10	25	20	30	20	20	0	3/4" C WITH 2#10, 1#10G***	
2	12	30	20	30	20	20	1	3/4" C WITH 2#10, 1#10G***	
3	17	40	30	30	30	30	2	3/4" C WITH 2#10, 1#10G	
5	28	70	50	60	50	50	2	3/4" C WITH 2#8, 1#8G*	
7.5	40	100	70	100	70	70	3	1" C WITH 2#6, 1#6G*	
10	50	125	90	100	90	90	3	1-1/4" C WITH 2#4, 1#6G*	

* WHEN FUSES ARE USED AS THE OCPD, THE GROUND CONDUCTOR SIZE MAY BE REDUCED BY ONE AWG SIZE.
 *** WHEN FUSES ARE USED AS THE OCPD, THE LINE AND GROUND CONDUCTOR SIZES MAY BE REDUCED BY ONE AWG SIZE.

horsepower rating in excess of 15 percent of the kilovolt-ampere rating of the transformer feeding it should use a reduced-voltage start.

There are several types of electromechanical as well as solid-state reduced-voltage starters that provide different starting characteristics. The following tables from Square D Company are a good representation of industry standard characteristics. Table 3.45(a) shows the starting characteristics for Square D's class 8600 series of reduced-voltage starters compared with full-voltage starting, along with the advantages and disadvantages of each type. Table 3.45(b) provides an aid in the selection of the starter best suited for a particular application and desired starting characteristic.

3.9 STANDARD VOLTAGES AND VOLTAGE DROP

Introduction

An understanding of system voltage nomenclature and preferred voltage ratings of distribution apparatus and utilization equipment is essential to ensure the proper design and operation of a power distribution system. The dynamic characteristics of the system should be recognized and the proper principles of voltage regulation applied so that satisfactory voltages will be supplied to utilization equipment under all normal conditions of operation.

System Voltage Classes

- *Low voltage:* A class of nominal system voltages 1,000 V or less
- *Medium voltage:* A class of nominal system voltages greater than 1,000 V but less than 100,000 V
- *High voltage:* A class of nominal system voltages equal to or greater than 100,000 V and equal to or less than 230,000 V

Standard Nominal System Voltages in the United States

These voltages and their associated tolerance limits are listed in ANSI C84.1-1989 for voltages from 120 to 230,000 V, and ANSI C92.2-1987, *Power Systems—Alternating Current Electrical Systems and Equipment Operating at Voltages Above 230 kV Nominal-Preferred Voltage Ratings*. The nominal system voltages and their associated tolerance limits and notes in the two standards have been combined in Table 3.46 to provide a single table, listing all the nominal system voltages and their associated tolerance limits for the United States. Preferred nominal system voltages and voltage ranges are shown in boldface type, whereas other systems in substantial use that are recognized as standard voltages are shown in medium type. Other voltages may be encountered on older systems, but

TABLE 3.45(a) Reduced-Voltage Starter Characteristics

Characteristic	Full Voltage	Autotransformer Class 8606	Wye-Delta Class 8630	Part Winding Class 8640	Primary Resistance Class 8647	Solid State AT523
Voltage at Motor	100%	50% / 65% / 80% (tap setting)	100%	100%	70%	Ramped Up
Line Current (% Full Load Current)	600%	150% / 250% / 380%	200%	390%	420%	200% to 500% (potentiometer adjustment)
Starting Torque (% Rated Torque)	150%	40% / 60% / 100%	50%	70%	75%	10% to 105% (function of i & V)
Start Time (Factory Setting)		6 - 7 sec	10 sec / 15 sec (open / closed transition)	1 - 1.5 sec	4 - 5 sec	10 sec (adjustable 5 to 30 sec)
Advantages	<ul style="list-style-type: none"> - Simple - Economical - High Starting Torque 	<ul style="list-style-type: none"> - High torque/amp - High inertial loads - Flexibility 	<ul style="list-style-type: none"> - High inertial loads - Long acceleration loads - Good torque/amp 	<ul style="list-style-type: none"> - Simple - Small size 	<ul style="list-style-type: none"> - Smooth acceleration - Motor voltage increases with speed 	<ul style="list-style-type: none"> - Greatest flexibility - Smooth ramp - Solid state O/L - Diagnostics
Disadvantages	<ul style="list-style-type: none"> - Abrupt starts - Large current inrush 	<ul style="list-style-type: none"> - Large size 	<ul style="list-style-type: none"> - Low torque - No flexibility 	<ul style="list-style-type: none"> - Not suitable for: High inertial loads - Frequent starting 	<ul style="list-style-type: none"> - Low current limitation - Heat dissipation - Short start time 	<ul style="list-style-type: none"> - SCR heat dissipation - Ambient limitations - Sensitive to power quality
Motor	Standard	Standard	Special	Special	Standard	Standard

TABLE 3.45(b) Reduced-Voltage Starter Selection Table

Application	Need		Comments
	Smooth Acceleration	Minimum Line Current	
High Inertial Loading	<ol style="list-style-type: none"> 1. Solid State 2. Autotransformer 3. Primary Resistor 4. Wye-Delta 5. Part Winding 	<ol style="list-style-type: none"> 1. Autotransformer 2. Solid State 3. Wye-Delta 4. Part Winding 5. Primary Resistor 	
Long Acceleration Time	<ol style="list-style-type: none"> 1. Solid State 2. Wye-Delta 3. Autotransformer 4. Primary Resistor 	<ol style="list-style-type: none"> 1. Solid State 2. Wye-Delta 3. Autotransformer 4. Primary Resistor 	<ul style="list-style-type: none"> * For acceleration times greater than 5 sec primary resistor requires non-std resistors * Part winding not suitable for acceleration time greater than 2 seconds
Frequent Starting	<ol style="list-style-type: none"> 1. Solid State 2. Wye-Delta 3. Primary Resistor 4. Autotransformer 	<ol style="list-style-type: none"> 1. Solid State 2. Wye-Delta 3. Primary Resistor 4. Autotransformer 	<ul style="list-style-type: none"> * Part winding is unsuitable for frequent starts
Flexibility in Selecting Starter Characteristics	<ol style="list-style-type: none"> 1. Solid State 2. Autotransformer 3. Primary Resistor 4. Part Winding 	<ol style="list-style-type: none"> 1. Solid State 2. Autotransformer 3. Primary Resistor 4. Part Winding 	<ul style="list-style-type: none"> * For primary resistor, resistor change required to change starting characteristics * Starting characteristics cannot be changed for Wye-Delta starters

FIGURE 3.37 Principal transformer connections to supply the system voltages of Table 3.46.

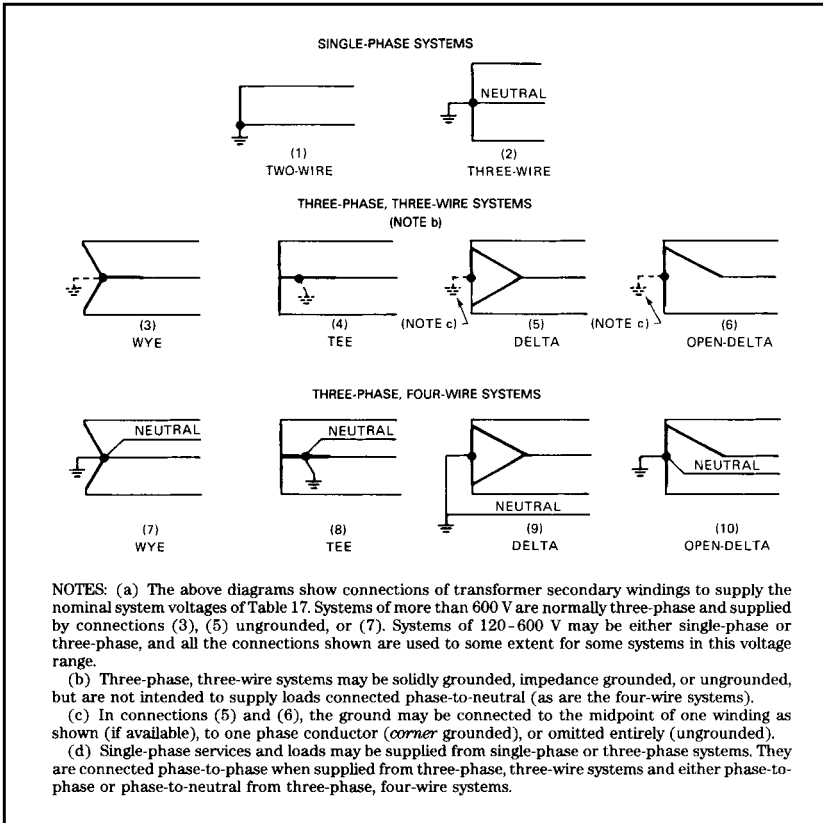

they are not recognized as standard voltages. The transformer connections from which these voltages are derived are shown in Figure 3.37.

Application of Voltage Classes

1. Low-voltage-class voltages are used to supply utilization equipment.
2. Medium-voltage-class voltages are used as primary distribution voltages to supply distribution transformers that step the medium voltage down to a low voltage to supply utilization equipment. Medium voltages of 13,800 V and below are also used to supply utilization equipment, such as large motors.
3. High-voltage-class voltages are used to transmit large amounts of electric power over transmission lines that interconnect transmission substations.

Voltage Systems Outside of the United States

Voltage systems in other countries (including Canada) generally differ from those in the United States. Also, the frequency in many countries is 50 Hz instead of 60 Hz, which affects the operation of some equipment, such as motors, which will run approximately 17 percent slower. Plugs and receptacles are generally different, which helps to prevent utilization equipment from the United States from being connected to the wrong voltage.

In general, equipment rated for use in the United States cannot be used outside of the United States, and vice versa. If electrical equipment made for use in the United States must be used outside the United States, and vice versa, information on the voltage, frequency, and type of plug required should be obtained. If the difference is only in the voltage, transformers are generally available to convert the supply voltage to the equipment voltage.

System Voltage Tolerance Limits

Table 3.46 lists two voltage ranges to provide a practical application of voltage tolerance limits to distribution systems.

Electric supply systems are to be designed and operated so that most service voltages fall within the Range A limits. User systems are to be designed and operated so that, when the service voltages are within Range A, the utilization voltages are within Range A. Utilization equipment is to be designed and rated to give fully satisfactory performance within Range A limits for utilization voltages.

Range B is provided to allow limited excursions of voltage outside the Range A limits that necessarily result from practical design and operating conditions. The supplying utility is expected to take action within a reasonable time to restore service voltages to Range A limits. The user is expected to take action within a reasonable time to restore utilization voltages to Range A limits. Insofar as practical, utilization equipment may be expected to give acceptable performance outside Range A but within Range B. When voltages occur outside the limits of Range B, prompt corrective action should be taken.

The voltage tolerance limits in ANSI C84.1-1989 are based on ANSI/NEMA MG1-1978, *Motors and Generators*, which establishes the voltage tolerance limits of the standard low-voltage induction motor at ± 10 percent of nameplate voltage ratings of 230 and 460 V. Because motors represent the major component of utilization equipment, they were given primary consideration in the establishment of this voltage standard.

The best way to show the voltages in a distribution system is by using a 120-V base. This cancels the transformation ratios between systems, so that the actual voltages vary solely on the basis of voltage drops in the

TABLE 3.46 Standard Nominal System Voltages and Voltage Ranges

VOLTAGE CLASS	NOMINAL SYSTEM VOLTAGE (Note a)				VOLTAGE RANGE A (Note b)			VOLTAGE RANGE B (Note b)			
	Two-wire	Three-wire	Four-wire	Nominal Utilization Voltage (Note 1) Two-wire Three-wire Four-wire	Maximum	Minimum		Maximum	Minimum		
					Utilization and Service Voltage (Note c)	Service Voltage	Utilization Voltage	Utilization and Service Voltage	Service Voltage	Utilization Voltage	
Low Voltage (Note 1)	Single-Phase Systems										
	120	120/240		115 115/230	126	114 114/228	110 110/220	127 127/254	110 110/220	106 106/212	
	Three-Phase Systems										
		240	208Y/128 (Note d) 480Y/277	200 230/115 230 460 460 575	218Y/128 252/126 252 504Y/281 504 456Y/263 570	197Y/114 228/114 228 456Y/263 456 570	191Y/110 220/110 220 440Y/254 440 550	220Y/127 254/127 254 508Y/293 508 635 (Note e)	191Y/110 (Note 2) 220/110 220 440Y/254 440 550	184Y/108 (Note 2) 212/108 212 424Y/245 424 530	
Medium Voltage	2400	4160 4800 6900	4160Y/2400	2520 4370 5040 7240	2340 4050Y/2340 4680 6730	2160 3740Y/2160 4320 6210	2540 4400 5080 7260	2280 3950Y/2280 4560 6560	2080 3600Y/2080 4160 5940		
		8320Y/4800 12000Y/6930 12470Y/7200 13200Y/7820 13800Y/7970		8730Y/5040 12600Y/7270 13090Y/7560 13860Y/8000 14490Y/8370	8110Y/4680 11700Y/6760 12160Y/7020 12870Y/7430 13460Y/7770	(Note f)	8800Y/5080 12700Y/7330 13200Y/7620 13970Y/8070 14520Y/8360	7900Y/4560 11400Y/6580 11850Y/6840 12504Y/7240 13110Y/7570	(Note g)		
	13800	20780Y/12000 22860Y/13200		21820Y/12600 24000Y/13860 24150	20260Y/11700 22290Y/12870 22430		(Note f)	22000Y/12700 24200Y/13970 24340		19740Y/11400 21720Y/12540 21850	(Note g)
	23000	24940Y/14400 34500Y/19920		26190Y/15120 36230Y/20920 36230	24320Y/14040 33640Y/19420 33640	(Note f)		26400Y/15240 36510Y/21080 36510	23690Y/13680 32788Y/18930 32780	(Note g)	
	34500	46000 69000									
	High Voltage	115 000	138 000 161 000 230 000			121 000 145 000 169 000 242 000					
		(Note h)									
			345 000 500 000 765 000 1 100 000			362 000 550 000 800 000 1 200 000					
	Extra-High Voltage										
	Ultra-High Voltage										

NOTES: (1) Minimum utilization voltages for 120-600 volt circuits not supplying lighting loads are as follows

Nominal System Voltage	Range A	Range B
120	108	104
(Note 2) 208Y/120	187Y/108	180Y/104
240/120	216/108	208/104
240	216	208
480Y/277	432Y/249	418Y/240
480	432	416
600	540	520

(2) Many 220 volt motors were applied on existing 208 volt systems on the assumption that the utilization voltage would not be less than 187 volts. Caution should be exercised in applying the Range B minimum voltages of Table 17 and Note (1) to existing 208 volt systems supplying such motors

(a) Three-phase, three-wire systems are systems in which only the three-phase conductors are carried out from the source for connection of loads. The source may be derived from any type of three-phase transformer connection, grounded or ungrounded. Three-phase, four-wire systems are systems in which a grounded neutral conductor is also carried out from the source for connection of loads. Four-wire systems in this table are designated by the phase-to-phase voltage, followed by the letter Y (except for the 240/120 V delta system), a slant line, and the phase-to-neutral voltage. Single-phase services and loads may be supplied from either single-phase or three-phase systems. The principal transformer connections that are used to supply single-phase and three-phase systems are illustrated in Fig. 3.

- (b) The voltage ranges in this table are illustrated in ANSI C84.1-1989, Appendix B [2].
- (c) For 120 - 600 V nominal systems, voltages in this column are maximum service voltages. Maximum utilization voltages would not be expected to exceed 125 V for the nominal system voltage of 120, nor appropriate multiples thereof for other nominal system voltages through 600 V.
- (d) A modification of this three-phase, four-wire system is available as a 120/208Y-volt service for single-phase, three-wire, open-wye applications.
- (e) Certain kinds of control and protective equipment presently available have a maximum voltage limit of 600 V; the manufacturer or power supplier or both should be consulted to assure proper application.
- (f) Utilization equipment does not generally operate directly at these voltages. For equipment supplied through transformers, refer to limits for nominal system voltage of transformer output.
- (g) For these systems, Range A and Range B limits are not shown because, where they are used as service voltages, the operating voltage level on the user's system is normally adjusted by means of voltage regulation to suit their requirements.
- (h) Standard voltages are reprinted from ANSI C92.2-1987 [3] for convenience only.
- (i) Nominal utilization voltages are for low-voltage motors and control. See ANSI C84.1-1989, Appendix C [2] for other equipment nominal utilization voltages (or equipment nameplate voltage ratings).

This material is reproduced with permission from C84.1-1989, American National Standard for Electric Power Systems and Equipment — Voltage Ratings (60 Hz), copyright 1989 by the American National Standards Institute. Copies of this standard may be purchased from the American National Standards Institute, 11 West 42nd Street, 13th Floor, New York, NY 10036.

system. Any voltage may be converted to a 120-V base by dividing the actual voltage by the ratio of transformation to the 120-V base. For example, the ratio of transformation for the 480-V system is 480/120, or 4, so 460 V in a 480-V system would be $460/4$, or 115 V.

The tolerance limits of the 460-V motor as they relate to the 120-V base become 115 V + 10 percent or 126.5 V, and 115 V – 10 percent, or 103.5 V. The problem is to decide how this tolerance range of 23 V should be divided between the primary distribution system, the distribution transformer, and the secondary distribution system that make up the regulated distribution system. The solution adopted by the American National Standards Committee C84 is shown in Table 3.47.

Voltage Profile Limits for a Regulated Distribution System

Figure 3.38 shows the voltage profile of a regulated power distribution system using the limits of Range A in Table 3.46. This table assumes a standard nominal distribution voltage of 13,200 V, Range A in Table 3.46, for the example profile shown.

System Voltage Nomenclature

The nominal system voltages in Table 3.46 are designated in the same way as the designation on the nameplate of the transformer for the winding or windings supplying the system.

1. Single-phase systems

- *120 V*: Indicates a single-phase, two-wire system in which the nominal voltage between the two wires is 120 V.
- *120/240 V*: Indicates a single-phase, three-wire system in which the nominal voltage between the two-phase conductors is 240 V, and from each phase conductor to the neutral is 120 V.

2. Three-phase systems

- *240/120 V*: Indicates a three-phase, four-wire system supplied from a delta-connected transformer. The midtap of one winding is connected to a neutral. The three phase conductors provide a nominal 240-V three-phase, three-wire system, and the neutral and two adjacent phase conductors provide a nominal 120/240-V single-phase, three-wire system.
- *Single number*: Indicates a three-phase, three-wire system in which the number designates the nominal voltage between phases.
- *Two numbers separated by Y/*: Indicates a three-phase, four-wire system from a wye-connected transformer in which the first number indicates the nominal phase-to-phase voltage and the second the nominal phase-to-neutral voltage.

TABLE 3.47 Standard Voltage Profile for a Regulated Power Distribution System, 120-Volt Base

	Range A	Range B
Maximum allowable voltage	126(125*)	127
Voltage-drop allowance for the primary distribution feeder	9	13
Minimum primary service voltage	117	114
Voltage-drop allowance for the distribution transformer	3	4
Minimum low-voltage service voltage	114	110
Voltage-drop allowance for the building wiring	6(4†)	6(4†)
Minimum utilization voltage	108(110†)	104(106†)

*For utilization voltages of 120-600 V.

†For building wiring circuits supplying lighting equipment.

NOTES

1. All single-phase systems and all three-phase, four-wire systems are suitable for the connection of phase-to-neutral load.
2. See Chapter 4 for methods of system grounding.
3. See Figure 3.37 for transformer connections.

Voltage Ratings for Utilization Equipment

According to the IEEE, utilization equipment is defined as “electrical equipment that converts electric power into some other form of energy, such as light, heat, or mechanical motion.” Every item of utilization

FIGURE 3.38 Voltage profile of the limits of range A, ANSI C84.1-1989.

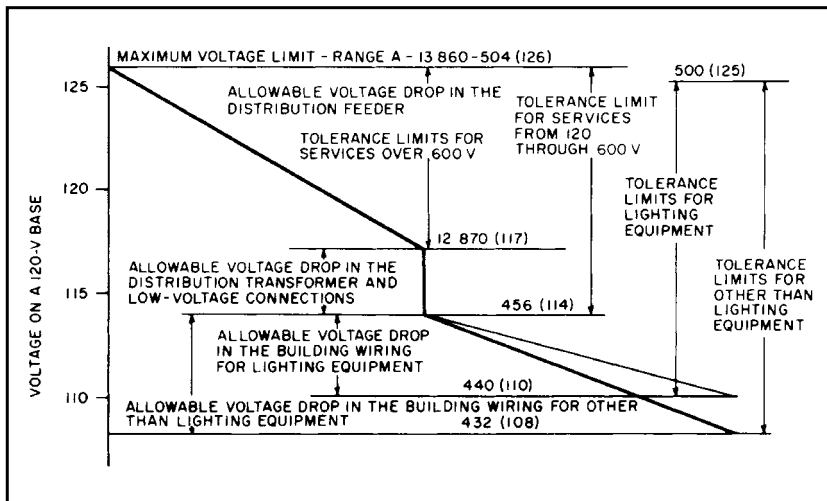

equipment should have a nameplate listing, which includes, among other things, the rated voltage for which the equipment is designed. With one major exception, most electrical utilization equipment carries a nameplate rating that is the same as the voltage system on which it is to be used; that is, equipment to be used on 120-V systems is rated 120 V, and so on. The major exception is motors and equipment containing motors. See Table 3.48 for the proper selection of the motor nameplate voltage that is compatible with the specific available nominal system voltage. Motors are also about the only utilization equipment used on systems over 600 V.

Effect of Voltage Variation on Utilization Equipment

Whenever the voltage at the terminals of utilization equipment varies from its nameplate rating, the performance of the equipment and its life expectancy change. The effect may be minor or serious, depending on the characteristics of the equipment and the amount of voltage deviation from the nameplate rating. NEMA standards provide tolerance limits within which performance will be acceptable. In precise operations, however, closer voltage control may be required. In general, a change in the applied voltage causes a proportional change in the current. Because the effect on the load equipment is proportional to the voltage and current, and because the current is proportional to the voltage, the total effect is approximately proportional to the square of the voltage.

However, the change is only approximately proportional and not exact, because the change in the current affects the operation of the equipment, so the current will continue to change until a new equilib-

TABLE 3.48 Voltage Ratings of Standard Motors

Nominal System Voltage	Nameplate Voltage
Single-phase motors	
120	115
240	230
Three-phase motors	
208	200
240	230
480	460
600	575
2400	2300
4160	4000
4800	4600
6900	6600
13 800	13 200

rium position is established. For example, when the load is a resistance heater, the increase in current will increase the temperature of the heater, which will increase its resistance, which will in turn reduce the current. This effect will continue until a new equilibrium current and temperature are established. In the case of an induction motor, a reduction in the voltage will cause a reduction in the current flowing to the motor, causing the motor to slow down. This reduces the impedance of the motor, causing an increase in the current until a new equilibrium position is established between the current and the motor speed.

EXAMPLES OF EFFECTS OF VOLTAGE VARIATION

The variations in characteristics of induction motors as a function of voltage are given in Table 3.49.

The light output and life of incandescent filament lamps are critically affected by the impressed voltage. The variation of life and light output with voltage is given in Table 3.50. The variation figures for 125- and 130-V lamps are also included, because these ratings are useful in locations where long life is more important than light output.

Fluorescent lamps, unlike incandescent lamps, operate satisfactorily over a range of ± 10 percent of the ballast nameplate voltage rating. Light output varies approximately in direct proportion to the applied voltage. Thus, a 1 percent increase in applied voltage will increase the light output by 1 percent, and, conversely, a decrease of 1 percent in the applied voltage will reduce the light output by 1 percent. The life of fluorescent lamps is affected less by voltage variation than the life of incandescent lamps.

The voltage-sensitive component of the fluorescent fixture is the ballast, which is a small reactor, or transformer, that supplies the starting and operating voltages to the lamp and limits the lamp current to design values. These ballasts may overheat when subjected to above-normal voltage and operating temperature, and ballasts with integral thermal protection may be required.

Mercury lamps that use the conventional unregulated ballast will have a 30 percent decrease in the light output for a 10 percent decrease in terminal voltage. When a constant wattage ballast is used, the decrease in light output for a 10 percent decrease in terminal voltage will be about 2 percent.

Mercury lamps require between 4 and 8 min to vaporize the mercury in the lamp and reach full brilliance. At about 20 percent undervoltage, the mercury arc will be extinguished and the lamp cannot be restarted until the mercury condenses, which takes between 4 and 8 min, unless the lamps have special cooling controls. The lamp life is related inversely to the number of starts; so that, if low-voltage conditions require repeated starting, lamp life will be affected adversely. Excessively high voltage raises the arc temperature, which could damage the glass enclosure when the temperature approaches the glass-softening point.

TABLE 3.49 General Effect of Voltage Variations on Induction Motor Characteristics

Characteristic	Function of Voltage	Voltage Variation	
		90% Voltage	110% Voltage
Starting and maximum running torque	(Voltage) ²	Decrease 19%	Increase 21%
Synchronous speed	Constant	No change	No change
Percent slip	1/(Voltage) ²	Increase 23%	Decrease 17%
Full-load speed	Synchronous speed-slip	Decrease 1.5%	Increase 1%
Efficiency			
Full load	—	Decrease 2%	Increase 0.5 to 1%
¾ load	—	Practically no change	Practically no change
½ load	—	Increase 1 to 2%	Decrease 1 to 2%
Power factor			
Full load	—	Increase 1%	Decrease 3%
¾ load	—	Increase 2 to 3%	Decrease 4%
½ load	—	Increase 4 to 5%	Decrease 5 to 6%
Full-load current	—	Increase 11%	Decrease 7%
Starting current	Voltage	Decrease 10 to 12%	Increase 10 to 12%
Temperature rise, full load	—	Increase 6 to 7 °C	Decrease 1 to 2 °C
Maximum overload capacity	(Voltage) ²	Decrease 19%	Increase 21%
Magnetic noise - no load in particular	—	Decrease slightly	Increase slightly

TABLE 3.50 Effect of Voltage Variations on Incandescent Lamps

Applied Voltage (volts)	120 V		Lamp Rating 125 V		130 V	
	Percent Life	Percent Light	Percent Life	Percent Light	Percent Life	Percent Light
105	575	64	880	55	—	—
110	310	74	525	65	880	57
115	175	87	295	76	500	66
120	100	100	170	88	280	76
125	58	118	100	100	165	88
130	34	132	59	113	100	100

Sodium and metal-halide lamps have similar characteristics to mercury lamps; however, the starting and operating voltages may be somewhat different. See the manufacturers' catalogs for detailed information.

In resistance heating devices, the energy input and, therefore, the heat output of resistance heaters varies approximately as the square of the impressed voltage. Thus, a 10 percent drop in voltage will cause a drop of approximately 19 percent in heat output. This, however, holds true only for an operating range over which the resistance remains approximately constant.

The foregoing gives some idea of how critical proper voltage is, and thus the need for voltage drop calculations.

Voltage Drop Calculations

Electrical design professionals designing building wiring systems should have a working knowledge of voltage drop calculations, not only to meet NEC, Articles 210.19(A), FPN No. 4, and 215.2, requirements (recommended, not mandatory), but also to ensure that the voltage applied to utilization equipment is maintained within proper limits. Due to the vector relationships of the circuit parameters, a working knowledge of trigonometry is needed, especially for making exact calculations. Fortunately, most voltage drop calculations are based on assumed limiting conditions, and approximate formulas are adequate. Within the context of this book, voltage drop tables and charts are sufficiently accurate to determine the approximate voltage drop for most problems, thus formulas will not be needed.

VOLTAGE DROP TABLES

These tables (Tables 3.51 through 3.72), reading directly in volts, give values for the voltage drop found in aluminum and copper cables under various circumstances.

- 1. In magnetic conduit—AC**
 - a.* 70 percent power factor
 - b.* 80 percent power factor
 - c.* 90 percent power factor
 - d.* 95 percent power factor
 - e.* 100 percent power factor
- 2. In nonmagnetic conduit—AC**
 - a.* 70 percent power factor
 - b.* 80 percent power factor
 - c.* 90 percent power factor
 - d.* 95 percent power factor
 - e.* 100 percent power factor
- 3. In direct-current circuits**

TABLE 3-51 Volts Drop for AL Conductor—Direct Current

WIRE SIZE AWG or MCM	Volts Drop																							
	1000	900	800	750	700	600	500	400	350	300	250	4/0	3/0	2/0	1/0	1	2	4	6	8*	10*	12*		
500,000	20.2	22.3	25.2	26.9	28.8	32.6	40.2	50.4	57.5	67.2	80.5	95.9	120.0	151.0	191.0	240.0	303.0	383.0	480.0	—	—	—	—	—
400,000	16.1	17.8	20.2	21.5	23.9	28.9	32.1	39.3	45.2	52.3	61.8	73.6	92.0	115.0	145.0	182.0	230.0	290.0	360.0	—	—	—	—	—
300,000	12.1	13.4	15.1	16.8	18.5	22.4	26.1	30.2	34.3	40.2	48.4	57.6	73.0	90.6	115.0	145.0	182.0	230.0	290.0	—	—	—	—	—
200,000	8.1	9.2	10.5	11.5	12.4	15.4	18.1	20.2	23.0	26.9	32.2	38.4	48.0	60.4	76.4	96.0	121.0	153.0	200.0	—	—	—	—	—
100,000	4.0	4.3	5.0	5.4	5.8	6.7	8.0	10.1	11.5	13.4	16.1	19.2	24.0	30.2	38.2	48.0	60.6	96.6	153.0	—	—	—	—	—
90,000	3.6	4.0	4.5	4.8	5.2	6.1	7.2	9.1	10.3	12.1	14.5	17.3	21.6	27.2	34.4	43.2	54.6	87.0	138.0	—	—	—	—	—
80,000	3.2	3.6	4.0	4.3	4.6	5.4	6.4	8.1	9.2	10.8	12.9	15.3	19.2	24.2	30.5	38.4	48.5	77.0	123.0	—	—	—	—	—
70,000	2.8	3.1	3.5	3.8	4.0	4.7	5.6	7.1	8.1	9.4	11.3	13.4	16.8	21.1	26.7	33.6	42.4	67.6	107.0	—	—	—	—	—
60,000	2.4	2.7	3.0	3.2	3.5	4.0	4.8	6.1	6.9	8.1	9.7	11.5	14.4	18.1	22.9	28.8	36.4	59.0	92.0	—	—	—	—	—
50,000	2.0	2.2	2.5	2.7	2.9	3.4	4.0	5.0	5.8	6.7	8.1	9.6	12.0	15.1	19.1	24.0	30.3	48.3	76.7	—	—	—	—	—
40,000	1.6	1.8	2.0	2.2	2.3	2.7	3.2	4.0	4.6	5.4	6.4	7.7	9.6	12.1	15.3	19.2	24.1	38.6	61.4	—	—	—	—	—
30,000	1.2	1.3	1.5	1.6	1.7	2.0	2.4	3.0	3.5	4.0	4.8	5.8	7.2	9.1	11.5	14.4	18.2	29.0	46.0	—	—	—	—	—
20,000	0.8	0.9	1.0	1.1	1.2	1.3	1.6	2.0	2.3	2.7	3.2	3.8	4.6	5.8	7.6	9.6	12.1	19.7	30.3	—	—	—	—	—
10,000	0.4	0.5	0.5	0.5	0.6	0.7	0.8	1.0	1.2	1.3	1.6	1.9	2.4	3.0	3.8	4.8	6.1	9.7	15.3	—	—	—	—	—
9,000	0.4	0.4	0.5	0.5	0.5	0.6	0.7	0.9	1.0	1.2	1.5	1.5	2.2	2.7	3.4	4.3	5.5	8.7	13.8	—	—	—	—	—
8,000	0.3	0.4	0.4	0.4	0.4	0.5	0.6	0.8	0.9	1.1	1.3	1.5	1.9	2.4	3.1	3.8	4.9	7.7	12.3	—	—	—	—	—
7,000	0.3	0.3	0.4	0.4	0.4	0.5	0.6	0.7	0.8	1.0	1.1	1.3	1.7	2.1	2.7	3.4	4.2	6.8	10.7	—	—	—	—	—
6,000	0.2	0.3	0.3	0.3	0.4	0.4	0.5	0.6	0.7	0.9	1.0	1.2	1.4	1.8	2.3	2.9	3.6	5.8	9.2	—	—	—	—	—
5,000	0.2	0.2	0.3	0.3	0.3	0.3	0.4	0.5	0.6	0.7	0.8	1.0	1.2	1.5	1.9	2.4	3.0	4.8	7.7	—	—	—	—	—
4,000	0.2	0.2	0.2	0.2	0.2	0.3	0.3	0.4	0.5	0.6	0.7	0.8	1.0	1.2	1.5	1.9	2.4	3.0	4.8	—	—	—	—	—
3,000	0.1	0.1	0.2	0.2	0.2	0.2	0.3	0.4	0.4	0.5	0.6	0.7	0.9	1.2	1.4	1.8	2.3	3.5	5.6	—	—	—	—	—
2,000	0.1	0.1	0.1	0.1	0.1	0.1	0.2	0.2	0.2	0.3	0.3	0.4	0.5	0.6	0.8	1.0	1.2	1.9	3.1	—	—	—	—	—
1,000	—	—	—	—	—	—	—	—	—	—	—	—	—	—	—	—	—	—	—	—	—	—	—	—
900	—	—	0.1	0.1	0.1	0.1	0.1	0.1	0.1	0.1	0.2	0.2	0.2	0.3	0.3	0.4	0.5	0.9	1.4	—	—	—	—	—
800	—	—	—	—	—	—	—	—	—	—	—	—	—	—	—	—	—	—	—	—	—	—	—	—
700	—	—	—	—	—	—	—	—	—	—	—	—	—	—	—	—	—	—	—	—	—	—	—	—
600	—	—	—	—	—	—	—	—	—	—	—	—	—	—	—	—	—	—	—	—	—	—	—	—
500	—	—	—	—	—	—	—	—	—	—	—	—	—	—	—	—	—	—	—	—	—	—	—	—
400	—	—	—	—	—	—	—	—	—	—	—	—	—	—	—	—	—	—	—	—	—	—	—	—
300	—	—	—	—	—	—	—	—	—	—	—	—	—	—	—	—	—	—	—	—	—	—	—	—
200	—	—	—	—	—	—	—	—	—	—	—	—	—	—	—	—	—	—	—	—	—	—	—	—
100	—	—	—	—	—	—	—	—	—	—	—	—	—	—	—	—	—	—	—	—	—	—	—	—

* Solid Conductors. Other conductors are stranded.

Note 1.—The footage employed in the tabulated ampere feet refers to the length of run of the circuit rather than to the footage of individual conductor.

Note 2.—The above table is figured at 60°C since this is an estimate of the average temperature which may be anticipated in service. The table may be used without significant error for conductor temperatures up to and including 75°C.

TABLE 3.52 Volts Drop for AL Conductor in Magnetic Conduit—70 Percent PF

WIRE SIZE AWG or MCM	1000	900	800	750	700	600	500	400	350	300	250	4/0	3/0	2/0	1/0	1	2	4	6	8*	10*	12*
Amperes Feet	Volts Drop																					
500,000	46.4	48.0	50.2	51.5	53.0	56.5	60.8	68.5	73.6	80.9	90.6	101.0	119.0	141.0	170.0	205.0	249.0	373.0	—	—	—	—
400,000	37.1	38.4	40.2	41.2	42.4	45.2	48.6	54.9	58.9	64.7	72.5	80.8	95.2	113.0	136.0	154.0	199.0	296.0	463.0	—	—	—
300,000	27.9	28.9	30.2	30.9	31.8	33.9	36.5	41.1	44.2	48.5	54.4	60.6	71.4	84.6	103.0	123.0	149.0	224.0	347.0	—	—	—
200,000	18.6	19.2	20.1	20.6	21.2	22.6	24.4	27.4	29.5	32.4	36.2	40.4	47.6	56.4	68.0	82.0	99.6	149.0	232.0	352.0	—	—
100,000	9.3	9.6	10.1	10.3	10.6	11.3	12.2	13.7	14.7	16.2	18.1	20.2	23.8	28.2	34.0	41.0	49.8	74.7	116.0	176.0	275.0	431.0
90,000	8.4	8.6	9.1	9.3	9.5	10.2	11.0	12.3	13.3	14.6	16.3	18.2	21.4	25.4	30.6	36.9	44.8	67.2	104.0	159.0	247.0	389.0
80,000	7.4	7.7	8.0	8.2	8.5	9.0	9.7	11.0	11.8	12.9	14.5	16.2	19.0	22.6	27.2	32.8	39.7	59.6	92.6	141.0	210.0	346.0
70,000	6.6	6.7	7.0	7.2	7.4	7.9	8.6	9.6	10.3	11.3	12.7	14.1	16.7	19.7	23.8	28.7	34.8	52.2	81.1	123.0	192.0	302.0
60,000	5.6	5.8	6.0	6.2	6.4	6.8	7.3	8.2	8.8	9.7	10.9	12.1	14.3	16.9	20.4	24.6	29.8	44.7	69.4	106.0	165.0	259.0
50,000	4.6	4.8	5.0	5.2	5.3	5.7	6.1	6.9	7.4	8.1	9.1	10.1	11.9	14.1	17.0	20.5	24.9	37.3	57.9	88.1	137.0	216.0
40,000	3.7	3.8	4.0	4.1	4.2	4.5	4.9	5.6	5.9	6.5	7.3	8.1	9.5	11.3	13.6	16.4	19.9	29.8	45.3	70.4	110.0	173.0
30,000	2.8	2.9	3.0	3.1	3.2	3.4	3.7	4.1	4.4	4.9	5.4	6.1	7.1	8.5	10.2	12.3	14.9	22.4	34.7	52.8	82.6	129.0
20,000	1.9	1.9	2.0	2.1	2.1	2.3	2.4	2.7	3.0	3.2	3.6	4.0	4.8	5.6	6.8	8.2	10.0	14.9	23.2	35.2	55.0	86.4
10,000	0.9	1.0	1.0	1.0	1.1	1.1	1.2	1.4	1.5	1.6	1.8	2.0	2.4	2.8	3.4	4.1	5.0	7.5	11.6	17.6	27.5	43.2
9,000	0.8	0.9	0.9	0.9	1.0	1.0	1.1	1.2	1.3	1.5	1.6	1.8	2.1	2.5	3.1	3.7	4.5	6.7	10.4	15.9	24.7	38.9
8,000	0.7	0.8	0.8	0.8	0.9	0.9	1.0	1.1	1.2	1.3	1.5	1.6	1.9	2.3	2.7	3.3	4.0	6.0	9.3	14.1	21.0	34.6
7,000	0.7	0.7	0.7	0.7	0.7	0.8	0.9	1.0	1.0	1.1	1.3	1.4	1.7	2.0	2.4	2.9	3.5	5.2	8.1	12.3	19.2	30.2
6,000	0.6	0.6	0.6	0.6	0.6	0.7	0.7	0.8	0.9	1.0	1.1	1.2	1.4	1.7	2.0	2.5	3.0	4.5	6.9	10.6	16.5	25.9
5,000	0.5	0.5	0.5	0.5	0.5	0.6	0.6	0.7	0.7	0.8	0.9	1.0	1.2	1.4	1.7	2.1	2.5	3.7	5.8	8.8	13.3	21.6
4,000	0.4	0.4	0.4	0.4	0.4	0.5	0.5	0.6	0.6	0.7	0.7	0.8	1.0	1.1	1.4	1.6	2.0	3.0	4.6	7.0	11.0	17.3
3,000	0.3	0.3	0.3	0.3	0.3	0.4	0.4	0.4	0.4	0.5	0.5	0.6	0.7	0.9	1.0	1.2	1.5	2.2	3.5	5.3	8.3	12.9
2,000	0.2	0.2	0.2	0.2	0.2	0.2	0.2	0.3	0.3	0.3	0.4	0.4	0.5	0.6	0.7	0.8	1.0	1.5	2.3	3.5	5.5	8.6
1,000	0.1	0.1	0.1	0.1	0.1	0.1	0.1	0.1	0.1	0.2	0.2	0.2	0.2	0.3	0.3	0.4	0.5	0.8	1.2	1.8	2.8	4.3
900	0.1	0.1	0.1	0.1	0.1	0.1	0.1	0.1	0.1	0.2	0.2	0.2	0.2	0.3	0.3	0.4	0.5	0.7	1.0	1.6	2.5	3.9
800	0.1	0.1	0.1	0.1	0.1	0.1	0.1	0.1	0.1	0.1	0.2	0.2	0.2	0.2	0.3	0.3	0.4	0.6	0.9	1.4	2.1	3.5
700	0.1	0.1	0.1	0.1	0.1	0.1	0.1	0.1	0.1	0.1	0.1	0.1	0.1	0.2	0.2	0.3	0.4	0.5	0.8	1.2	1.9	3.0
600	0.1	0.1	0.1	0.1	0.1	0.1	0.1	0.1	0.1	0.1	0.1	0.1	0.1	0.2	0.2	0.3	0.3	0.5	0.7	1.1	1.7	2.6
500	0.1	0.1	0.1	0.1	0.1	0.1	0.1	0.1	0.1	0.1	0.1	0.1	0.1	0.1	0.2	0.2	0.3	0.4	0.6	0.9	1.4	2.2
400	—	—	—	—	—	0.1	0.1	0.1	0.1	0.1	0.1	0.1	0.1	0.1	0.1	0.2	0.2	0.3	0.5	0.7	1.1	1.7
300	—	—	—	—	—	—	—	—	—	—	0.1	0.1	0.1	0.1	0.1	0.2	0.2	0.4	0.5	0.8	1.3	2.0
200	—	—	—	—	—	—	—	—	—	—	—	—	—	—	0.1	0.1	0.2	0.2	0.4	0.6	0.9	1.3
100	—	—	—	—	—	—	—	—	—	—	—	—	—	—	—	—	0.1	0.1	0.1	0.2	0.3	0.4

* Solid Conductors. Other conductors are stranded.

Note 1—The above table gives voltage drops encountered in a single phase two-wire system. The voltage drops in other systems may be obtained through multiplication by appropriate factors listed below:

System for Which Voltage Drop Is Desired	Multiplying Factors for Modification of Values in Table
Single Phase—3 Wire—Line to Line	1.00
Single Phase—3 Wire—Line to Neutral	0.50
Three Phase—3 Wire—Line to Line	0.866
Three Phase—4 Wire—Line to Line	0.866
Three Phase—4 Wire—Line to Neutral	0.50

Note 3—The footage employed in the tabulated amperes feet refers to the length of run of the circuit rather than to the footage of individual conductor.

Note 4—The above table is figured at 60°C since this is an estimate of the average temperature which may be anticipated in service. The table may be used without significant error for conductor temperatures up to and including 75°C.

Note 2—Allowable voltage drops for systems other than single phase, two wire cannot be used directly in the above table. Such drops should be modified through multiplication by the appropriate factor listed below. The voltage thus modified may then be used to obtain the proper wire size directly from the table.

System for Which Allowable Voltage Drop Is Known	Multiplying Factor for Modification of Known Value to Permit Direct Use of Table
Single Phase—3 Wire—Line to Line	1.00
Single Phase—3 Wire—Line to Neutral	2.00
Three Phase—3 Wire—Line to Line	1.155
Three Phase—4 Wire—Line to Line	1.155
Three Phase—4 Wire—Line to Neutral	2.00

TABLE 3.53 Volts Drop for AL Conductor in Magnetic Conduit—80 Percent PF

WIRE SIZE AWG or MCM	1000	900	800	750	700	600	500	400	350	300	250	4/0	3/0	2/0	1/0	1	2	4	6	8*	10*	12*
Amperes Feet	Volts Drop																					
500,000	44.0	46.0	48.0	49.0	51.0	55.0	60.0	69.0	74.0	82.0	94.0	105.0	125.0	150.0	183.0	223.0	273.0	419.0	—	—	—	—
400,000	35.2	36.8	38.4	39.2	40.8	44.0	48.0	55.2	59.2	65.6	75.2	84.0	100.0	120.0	146.0	178.0	218.0	335.0	—	—	—	—
300,000	26.4	27.6	28.8	29.4	30.6	33.0	36.0	41.4	44.4	49.2	51.4	63.0	75.0	90.0	110.0	134.0	164.0	251.0	389.0	—	—	—
200,000	17.6	18.4	19.2	19.6	20.4	22.0	24.0	27.6	29.6	32.8	37.6	42.0	50.0	60.0	73.2	89.2	109.0	168.0	259.0	398.0	—	—
100,000	8.8	9.2	9.6	9.8	10.2	11.0	12.0	13.8	14.8	16.4	18.8	21.0	25.0	30.0	36.6	44.6	54.6	83.8	130.0	199.0	311.0	492.0
90,000	7.9	8.3	8.6	8.8	9.2	9.9	10.8	12.4	13.3	14.8	16.9	18.9	22.5	27.0	32.9	41.4	49.1	75.4	117.0	179.0	280.0	443.0
80,000	7.0	7.4	7.7	7.8	8.2	8.8	9.6	11.0	11.8	13.1	15.0	16.8	20.0	24.0	29.3	35.7	43.7	67.0	104.0	159.0	249.0	394.0
70,000	6.2	6.4	6.7	6.9	7.1	7.7	8.4	9.7	10.4	11.8	13.2	14.7	17.5	21.0	25.6	31.2	38.2	58.7	90.9	139.0	218.0	345.0
60,000	5.3	5.5	5.8	5.8	6.1	6.6	7.2	8.3	8.9	9.8	11.3	12.6	15.0	18.0	21.9	26.8	32.8	50.3	77.9	119.0	187.0	295.0
50,000	4.4	4.6	4.8	4.9	5.1	5.5	6.0	6.9	7.4	8.2	9.4	10.5	12.5	15.0	18.3	22.3	27.3	41.9	64.9	99.4	156.0	246.0
40,000	3.5	3.7	3.8	3.9	4.1	4.4	4.8	5.5	5.9	6.6	7.5	8.4	10.0	12.0	14.6	17.8	21.8	33.5	51.9	79.6	124.0	197.0
30,000	2.6	2.8	2.9	2.9	3.1	3.3	3.6	4.1	4.4	4.9	5.1	6.3	7.5	9.0	11.0	13.4	16.4	25.1	38.9	59.7	93.3	148.0
20,000	1.8	1.8	1.9	2.0	2.0	2.2	2.4	2.8	2.9	3.3	3.8	4.2	5.0	6.0	7.3	8.9	10.9	16.8	25.9	39.8	62.2	98.4
10,000	0.9	0.9	1.0	1.0	1.0	1.1	1.2	1.4	1.6	1.6	1.9	2.1	2.5	3.0	3.7	4.5	5.5	8.4	13.0	19.9	31.1	49.2
9,000	0.8	0.8	0.9	0.9	0.9	1.0	1.1	1.2	1.3	1.5	1.7	1.9	2.3	2.7	3.3	4.1	4.9	7.5	11.7	17.9	28.0	44.3
8,000	0.7	0.7	0.8	0.8	0.8	0.9	1.0	1.1	1.2	1.3	1.5	1.7	2.0	2.4	2.9	3.6	4.4	6.7	10.4	15.9	24.9	39.4
7,000	0.6	0.6	0.7	0.7	0.7	0.8	0.8	1.0	1.0	1.2	1.3	1.5	1.8	2.1	2.6	3.1	3.8	5.9	9.1	13.9	21.8	34.5
6,000	0.5	0.6	0.6	0.6	0.6	0.7	0.7	0.8	0.9	1.0	1.1	1.3	1.5	1.8	2.2	2.7	3.3	5.0	7.8	11.9	18.7	29.5
5,000	0.4	0.5	0.5	0.5	0.5	0.6	0.6	0.7	0.7	0.8	0.9	1.1	1.3	1.5	1.8	2.2	2.7	4.2	6.5	9.9	15.6	24.6
4,000	0.4	0.4	0.4	0.4	0.4	0.4	0.5	0.6	0.6	0.8	0.8	0.8	1.0	1.2	1.5	1.8	2.2	3.4	5.2	8.0	12.4	19.7
3,000	0.3	0.3	0.3	0.3	0.3	0.3	0.4	0.4	0.4	0.5	0.6	0.6	0.8	0.9	1.1	1.3	1.6	2.5	3.9	5.9	9.3	14.8
2,000	0.2	0.2	0.2	0.2	0.2	0.2	0.3	0.3	0.3	0.4	0.4	0.5	0.6	0.7	0.9	1.1	1.7	2.6	4.0	6.2	9.8	
1,000	0.1	0.1	0.1	0.1	0.1	0.1	0.1	0.2	0.2	0.2	0.2	0.3	0.3	0.4	0.5	0.6	0.8	1.3	2.0	3.1	4.9	
900	0.1	0.1	0.1	0.1	0.1	0.1	0.1	0.1	0.1	0.2	0.2	0.2	0.2	0.3	0.3	0.4	0.5	0.8	1.2	1.8	2.8	4.4
800	0.1	0.1	0.1	0.1	0.1	0.1	0.1	0.1	0.1	0.1	0.2	0.2	0.2	0.2	0.3	0.4	0.4	0.7	1.0	1.6	2.5	3.9
700	0.1	0.1	0.1	0.1	0.1	0.1	0.1	0.1	0.1	0.1	0.1	0.1	0.2	0.2	0.3	0.3	0.4	0.6	0.9	1.4	2.2	3.5
600	0.1	0.1	0.1	0.1	0.1	0.1	0.1	0.1	0.1	0.1	0.1	0.1	0.2	0.2	0.2	0.3	0.3	0.5	0.8	1.2	1.9	3.0
500	—	0.1	0.1	0.1	0.1	0.1	0.1	0.1	0.1	0.1	0.1	0.1	0.1	0.1	0.2	0.2	0.3	0.4	0.7	1.0	1.6	2.5
400	—	—	—	—	—	—	0.1	0.1	0.1	0.1	0.1	0.1	0.1	0.1	0.2	0.2	0.3	0.5	0.8	1.2	2.0	
300	—	—	—	—	—	—	—	0.1	0.1	0.1	0.1	0.1	0.1	0.1	0.1	0.2	0.3	0.4	0.6	0.9	1.5	
200	—	—	—	—	—	—	—	—	—	—	—	—	0.1	0.1	0.1	0.1	0.2	0.3	0.4	0.6	1.0	
100	—	—	—	—	—	—	—	—	—	—	—	—	—	—	0.1	0.1	0.1	0.2	0.3	0.4	0.6	

* Solid Conductors. Other conductors are stranded.

Note 1—The above table gives voltage drops encountered in a single phase two-wire system. The voltage drops in other systems may be obtained through multiplication by appropriate factors listed below:

System for Which Voltage Drop is Desired	Multiplying Factors for Modification of Values in Table
Single Phase—3 Wire—Line to Line	1.00
Single Phase—3 Wire—Line to Neutral	0.50
Three Phase—3 Wire—Line to Line	0.866
Three Phase—4 Wire—Line to Line	0.866
Three Phase—4 Wire—Line to Neutral	0.50

Note 2—Allowable voltage drops for systems other than single phase, two wire cannot be used directly in the above table. Such drops should be modified through multiplication by the appropriate factor listed below. The voltage thus modified may then be used to obtain the proper wire size directly from the table.

System for Which Allowable Voltage Drop is Known	Multiplying Factor for Modification of Known Value to Permit Direct Use of Table
Single Phase—3 Wire—Line to Line	1.00
Single Phase—3 Wire—Line to Neutral	2.00
Three Phase—3 Wire—Line to Line	1.155
Three Phase—4 Wire—Line to Line	1.155
Three Phase—4 Wire—Line to Neutral	2.00

Note 3—The footage employed in the tabulated ampere feet refers to the length of run of the circuit rather than to the footage of individual conductor.

Note 4—The above table is figured at 60°C since this is an estimate of the average temperature which may be anticipated in service. The table may be used without significant error for conductor temperatures up to and including 75°C.

TABLE 3.54 Volts Drop for AL Conductor in Magnetic Conduit—90 Percent PF

WIRE SIZE AWG or MCM	1000	900	800	750	700	600	500	400	350	300	250	4/0	3/0	2/0	1/0	1	2	4	6	8*	10*	12*
	Volts Drop																					
600,000	39.6	41.5	44.0	45.6	47.4	51.0	57.3	66.5	73.0	81.7	83.9	107.0	130.0	157.0	194.0	239.0	295.0	459.0	—	—	—	—
400,000	31.7	33.2	35.2	36.4	39.9	40.8	45.8	53.2	58.4	65.4	75.1	85.6	104.0	125.0	156.0	191.0	236.0	367.0	—	—	—	—
300,000	23.8	24.0	26.4	27.4	28.4	30.6	34.4	39.9	43.8	49.0	56.3	64.2	78.0	94.2	116.0	143.0	177.0	276.0	430.0	—	—	—
200,000	15.9	16.8	17.8	18.2	18.9	20.4	22.9	26.6	29.2	32.7	37.5	42.8	52.0	62.8	77.6	96.6	118.0	184.0	287.0	440.0	—	—
100,000	7.9	8.3	8.9	9.1	9.5	10.2	11.5	13.3	14.6	16.3	18.8	21.4	26.0	31.4	38.8	47.8	59.0	91.9	143.0	220.0	247.0	—
90,000	7.1	7.5	7.9	8.2	8.5	9.2	10.3	12.0	13.1	14.7	16.9	19.3	23.4	28.2	35.0	43.0	53.1	82.7	128.0	199.0	313.0	496.0
80,000	6.3	6.6	7.0	7.3	7.6	8.2	9.2	10.6	11.7	13.1	15.0	17.1	20.8	25.1	31.0	38.2	47.2	73.5	115.0	177.0	278.0	440.0
70,000	5.6	5.8	6.2	6.4	6.6	7.1	8.0	9.3	10.2	11.4	13.1	15.0	18.2	22.0	27.2	33.5	41.8	64.3	100.0	155.0	243.0	385.0
60,000	4.9	5.0	5.3	5.5	5.7	6.1	6.9	8.0	8.8	9.8	11.3	12.8	15.6	18.8	23.3	28.7	35.4	55.1	86.0	133.0	208.0	330.0
50,000	4.0	4.2	4.4	4.6	4.7	5.1	5.7	6.7	7.3	8.2	9.4	10.7	13.0	15.7	19.4	23.9	29.5	45.8	71.5	110.0	174.0	275.0
40,000	3.2	3.3	3.5	3.6	4.0	4.1	4.6	5.3	5.8	6.5	7.6	8.6	10.4	12.5	15.5	19.1	23.6	36.7	57.3	88.0	139.0	220.0
30,000	2.4	2.5	2.6	2.7	2.8	3.1	3.4	4.0	4.4	4.9	5.6	6.4	7.8	9.4	11.6	14.3	17.7	27.6	43.0	66.0	104.0	166.0
20,000	1.6	1.7	1.8	1.8	1.9	2.0	2.3	2.7	2.9	3.3	3.8	4.3	5.2	6.3	7.8	9.6	11.8	18.4	28.7	44.0	69.4	110.0
10,000	0.8	0.8	0.9	0.9	1.0	1.0	1.2	1.3	1.5	1.6	1.9	2.1	2.6	3.1	3.9	4.8	6.0	9.2	14.3	22.0	34.7	55.0
9,000	0.7	0.8	0.8	0.8	0.9	0.9	1.0	1.2	1.3	1.5	1.7	1.9	2.3	2.8	3.5	4.3	5.3	8.3	12.8	19.9	31.3	49.5
8,000	0.6	0.7	0.7	0.7	0.8	0.8	0.9	1.1	1.2	1.3	1.5	1.7	2.1	2.6	3.1	3.8	4.7	7.4	11.5	17.7	27.8	44.0
7,000	0.6	0.6	0.6	0.6	0.6	0.7	0.7	0.8	0.9	1.0	1.1	1.3	1.6	1.8	2.2	2.7	3.4	4.2	6.4	10.0	15.5	24.3
6,000	0.5	0.5	0.5	0.6	0.6	0.6	0.7	0.8	0.9	1.0	1.1	1.3	1.6	1.9	2.3	2.9	3.5	6.5	8.6	13.3	20.8	33.0
5,000	0.4	0.4	0.4	0.5	0.5	0.5	0.6	0.7	0.7	0.8	0.9	1.1	1.3	1.6	1.9	2.4	3.0	4.6	7.2	11.0	17.4	27.5
4,000	0.3	0.3	0.4	0.4	0.4	0.4	0.5	0.5	0.6	0.7	0.8	0.9	1.0	1.3	1.5	1.9	2.4	3.7	5.7	8.8	13.8	22.0
3,000	0.2	0.2	0.3	0.3	0.3	0.3	0.3	0.4	0.4	0.5	0.6	0.6	0.8	0.9	1.2	1.4	1.8	2.8	4.3	6.6	10.4	16.5
2,000	0.2	0.2	0.2	0.2	0.2	0.2	0.2	0.3	0.3	0.3	0.4	0.4	0.5	0.6	0.8	1.0	1.2	1.8	2.8	4.4	6.8	11.0
1,000	0.1	0.1	0.1	0.1	0.1	0.1	0.1	0.1	0.1	0.2	0.2	0.2	0.3	0.3	0.4	0.5	0.6	0.9	1.4	2.2	3.5	5.5
900	0.1	0.1	0.1	0.1	0.1	0.1	0.1	0.1	0.1	0.2	0.2	0.2	0.2	0.3	0.4	0.4	0.5	0.8	1.3	2.0	3.1	5.0
800	0.1	0.1	0.1	0.1	0.1	0.1	0.1	0.1	0.1	0.1	0.1	0.1	0.2	0.2	0.2	0.3	0.3	0.4	0.6	1.0	1.6	2.6
700	0.1	0.1	0.1	0.1	0.1	0.1	0.1	0.1	0.1	0.1	0.1	0.1	0.2	0.2	0.2	0.3	0.3	0.4	0.6	1.0	1.6	2.4
600	0.1	0.1	0.1	0.1	0.1	0.1	0.1	0.1	0.1	0.1	0.1	0.1	0.2	0.2	0.2	0.2	0.2	0.3	0.4	0.6	0.9	1.3
500	—	—	—	—	0.1	0.1	0.1	0.1	0.1	0.1	0.1	0.1	0.1	0.1	0.2	0.2	0.3	0.5	0.7	1.1	1.7	2.8
400	—	—	—	—	—	—	0.1	0.1	0.1	0.1	0.1	0.1	0.1	0.1	0.2	0.2	0.2	0.4	0.6	0.9	1.4	2.2
300	—	—	—	—	—	—	—	—	—	—	0.1	0.1	0.1	0.1	0.1	0.1	0.2	0.3	0.4	0.7	1.0	1.7
200	—	—	—	—	—	—	—	—	—	—	—	—	—	—	0.1	0.1	0.1	0.2	0.3	0.4	0.7	1.1
100	—	—	—	—	—	—	—	—	—	—	—	—	—	—	—	—	0.1	0.1	0.1	0.2	0.4	0.6

* Solid Conductors. Other conductors are stranded.

Note 1—The above table gives voltage drops encountered in a single phase two-wire system. The voltage drops in other systems may be obtained through multiplication by appropriate factors listed below:

System for Which Voltage Drop is Desired	Multiplying Factors for Modification of Values in Table
Single Phase—3 Wire—Line to Line	1.00
Single Phase—3 Wire—Line to Neutral	0.50
Three Phase—3 Wire—Line to Line	0.866
Three Phase—4 Wire—Line to Line	0.866
Three Phase—4 Wire—Line to Neutral	0.50

Note 3—The footage employed in the tabulated ampere feet refers to the length of run of the circuit rather than to the footage of individual conductor.

Note 4—The above table is figured at 60°C since this is an estimate of the average temperature which may be anticipated in service. The table may be used without significant error for conductor temperatures up to and including 75°C.

Note 2—Allowable voltage drops for systems other than single phase, two wire cannot be used directly in the above table. Such drops should be modified through multiplication by the appropriate factor listed below. The voltage thus modified may then be used to obtain the proper wire size directly from the table.

System for Which Allowable Voltage Drop is Known	Multiplying Factor for Modification of Known Value to Permit Direct Use of Table
Single Phase—3 Wire—Line to Line	1.00
Single Phase—3 Wire—Line to Neutral	2.00
Three Phase—3 Wire—Line to Line	1.155
Three Phase—4 Wire—Line to Line	1.155
Three Phase—4 Wire—Line to Neutral	2.00



TABLE 3.55 Volts Drop for AL Conductor in Magnetic Conduit—95 Percent PF

WIRE SIZE AWG or MCM	1000	900	800	750	700	600	500	400	350	300	250	4/0	3/0	2/0	1/0	1	2	4	6	8*	10*	12*
Amps Feet	Volts Drop																					
500,000	35.7	37.7	40.3	41.9	43.8	48.0	54.0	63.6	70.4	79.4	92.2	106.0	130.0	158.0	197.0	244.0	304.0	476.0	—	—	—	—
400,000	28.6	30.2	32.2	33.5	35.0	38.4	43.2	50.9	56.3	65.6	73.7	84.8	104.0	126.0	160.0	195.0	243.0	380.0	—	—	—	—
300,000	21.4	22.6	24.2	25.2	26.3	29.8	32.4	38.2	42.2	47.6	55.3	63.6	78.0	94.8	118.0	146.0	182.0	285.0	448.0	—	—	—
200,000	14.3	15.1	15.1	15.8	17.5	19.2	21.5	25.4	28.2	31.8	36.9	42.4	52.0	63.2	78.8	97.6	122.0	190.0	299.0	462.0	—	—
100,000	7.1	7.5	8.1	8.4	8.8	9.6	10.8	12.6	14.1	15.9	18.5	21.2	26.0	31.6	39.4	48.8	60.8	95.2	149.0	231.0	365.0	—
90,000	6.4	6.8	7.3	7.6	7.9	8.6	9.7	11.5	12.7	14.1	16.6	19.1	23.4	28.4	35.4	43.9	54.8	85.7	134.0	200.0	328.0	—
80,000	5.7	6.0	6.5	6.7	7.0	7.7	8.6	10.2	11.3	12.7	14.8	17.0	20.8	25.3	31.5	39.1	48.7	78.2	119.0	185.0	292.0	463.0
70,000	5.0	5.3	5.6	5.9	6.1	6.7	7.6	8.9	9.9	11.1	12.9	14.8	18.2	22.1	27.6	34.1	42.6	66.7	105.0	162.0	255.0	404.0
60,000	4.3	4.5	4.8	5.0	5.3	5.8	6.5	7.6	8.5	9.5	11.1	12.7	15.6	19.0	23.6	29.3	36.5	67.2	89.6	139.0	219.0	347.0
50,000	3.6	3.8	4.0	4.2	4.4	4.8	5.4	6.4	7.0	7.9	9.2	10.6	13.0	15.8	19.7	24.4	30.4	47.6	74.7	116.0	182.0	289.0
40,000	2.9	3.0	3.2	3.4	3.5	3.8	4.3	5.1	5.6	6.6	7.4	8.5	10.4	12.6	15.8	19.5	24.3	38.0	69.8	102.4	146.0	231.0
30,000	2.1	2.3	2.4	2.5	2.6	2.9	3.2	3.8	4.2	4.8	5.5	6.4	7.8	9.5	11.8	14.6	18.2	28.6	44.8	69.3	109.0	173.0
20,000	1.4	1.5	1.6	1.7	1.8	1.9	2.2	2.5	2.8	3.2	3.7	4.2	5.2	6.3	7.9	9.8	12.2	19.0	29.9	46.2	73.0	116.0
10,000	0.7	0.8	0.8	0.8	0.9	1.0	1.1	1.3	1.4	1.6	1.9	2.1	2.6	3.2	3.9	4.9	6.1	9.5	14.9	23.1	36.5	67.8
5,000	0.6	0.7	0.7	0.8	0.8	0.9	1.0	1.2	1.3	1.4	1.7	1.9	2.3	2.8	3.5	4.4	5.5	8.6	13.4	20.8	32.8	52.0
8,000	0.6	0.6	0.7	0.7	0.7	0.8	0.9	1.0	1.1	1.3	1.5	1.7	2.1	2.5	3.2	3.9	4.9	7.6	11.9	18.5	29.2	46.3
7,000	0.6	0.6	0.6	0.6	0.6	0.7	0.8	0.9	1.0	1.1	1.3	1.5	1.8	2.2	2.8	3.4	4.3	6.7	10.5	16.2	25.6	40.4
6,000	0.4	0.5	0.5	0.5	0.5	0.6	0.7	0.8	0.9	1.0	1.1	1.3	1.6	1.9	2.4	2.9	3.7	6.7	9.0	13.9	21.9	34.7
5,000	0.4	0.4	0.4	0.4	0.4	0.5	0.5	0.6	0.7	0.8	0.9	1.1	1.3	1.6	2.0	2.4	3.0	4.8	7.5	11.6	18.2	28.9
4,000	0.3	0.3	0.3	0.3	0.4	0.4	0.4	0.5	0.6	0.7	0.7	0.9	1.0	1.3	1.6	2.0	2.4	3.8	6.0	9.2	14.6	23.1
3,000	0.2	0.2	0.2	0.3	0.3	0.3	0.3	0.4	0.4	0.5	0.6	0.6	0.8	1.0	1.2	1.5	1.8	2.9	4.5	6.9	10.9	17.3
2,000	0.1	0.2	0.2	0.2	0.2	0.2	0.2	0.3	0.3	0.3	0.4	0.4	0.5	0.6	0.8	1.0	1.2	1.9	3.0	4.6	7.3	11.6
1,000	0.1	0.1	0.1	0.1	0.1	0.1	0.1	0.1	0.1	0.2	0.2	0.2	0.3	0.3	0.4	0.5	0.6	1.0	1.5	2.3	3.7	5.8
900	0.1	0.1	0.1	0.1	0.1	0.1	0.1	0.1	0.1	0.1	0.2	0.2	0.2	0.3	0.4	0.4	0.6	0.9	1.3	2.1	3.3	5.2
800	0.1	0.1	0.1	0.1	0.1	0.1	0.1	0.1	0.1	0.1	0.2	0.2	0.2	0.3	0.4	0.5	0.8	1.2	1.9	2.9	4.6	
700	0.1	0.1	0.1	0.1	0.1	0.1	0.1	0.1	0.1	0.1	0.1	0.1	0.1	0.2	0.2	0.3	0.3	0.4	0.7	1.1	1.6	2.4
600	—	0.1	0.1	0.1	0.1	0.1	0.1	0.1	0.1	0.1	0.1	0.1	0.2	0.2	0.2	0.3	0.4	0.6	0.9	1.4	2.2	3.5
600	—	—	—	—	—	0.1	0.1	0.1	0.1	0.1	0.1	0.1	0.1	0.1	0.2	0.2	0.3	0.5	0.8	1.2	1.8	2.9
400	—	—	—	—	—	—	0.1	0.1	0.1	0.1	0.1	0.1	0.1	0.1	0.2	0.2	0.4	0.6	0.9	1.5	2.3	
300	—	—	—	—	—	—	—	—	—	0.1	0.1	0.1	0.1	0.1	0.2	0.2	0.3	0.5	0.7	1.1	1.7	
200	—	—	—	—	—	—	—	—	—	—	—	—	0.1	0.1	0.1	0.1	0.2	0.3	0.5	0.7	1.2	
100	—	—	—	—	—	—	—	—	—	—	—	—	—	—	0.1	0.1	0.2	0.2	0.4	0.6	1.0	

* Solid Conductors. Other conductors are stranded.

Note 1—The above table gives voltage drops encountered in a single phase two-wire system. The voltage drops in other systems may be obtained through multiplication by appropriate factors listed below:

System for Which Voltage Drop is Desired	Multiplying Factors for Modification of Values in Table
Single Phase—3 Wire—Line to Line	1.00
Single Phase—3 Wire—Line to Neutral	0.50
Three Phase—3 Wire—Line to Line	0.866
Three Phase—4 Wire—Line to Line	0.866
Three Phase—4 Wire—Line to Neutral	0.50

Note 2—Allowable voltage drops for systems other than single phase, two wire cannot be used directly in the above table. Such drops should be modified through multiplication by the appropriate factor listed below. The voltage thus modified may then be used to obtain the proper wire size directly from the table.

System for Which Allowable Voltage Drop is Known	Multiplying Factor for Modification of Known Value to Permit Direct Use of Table
Single Phase—3 Wire—Line to Line	1.00
Single Phase—3 Wire—Line to Neutral	2.00
Three Phase—3 Wire—Line to Line	1.155
Three Phase—4 Wire—Line to Line	1.155
Three Phase—4 Wire—Line to Neutral	2.00

Note 3—The footage employed in the tabulated ampere feet refers to the length of run of the circuit rather than to the footage of individual conductor.

Note 4—The above table is figured at 60°C since this is an estimate of the average temperature which may be anticipated in service. The table may be used without significant error for conductor temperatures up to and including 75°C.



TABLE 3.56 Volts Drop for AL Conductor in Magnetic Conduit—100 Percent PF

WIRE SIZE AWG or MCM	1000	900	800	750	700	600	500	400	350	300	250	4/0	3/0	2/0	1/0	1	2	4	6	8*	10*	12*
Amperes Feet	V o l t s D r o p																					
500,000	24.0	25.9	28.5	30.1	32.0	36.2	42.6	52.4	59.2	68.5	81.8	96.8	121.0	151.0	191.0	240.0	303.0	483.0	—	—	—	—
400,000	19.2	20.7	22.8	24.1	25.6	29.0	34.1	41.9	47.4	54.8	65.4	77.4	95.8	121.0	153.0	192.0	241.0	386.0	—	—	—	—
350,000	14.4	15.6	17.1	18.1	19.2	21.7	25.5	31.4	35.5	41.1	49.1	58.1	72.6	90.6	115.0	144.0	182.0	290.0	460.0	—	—	—
200,000	9.6	10.3	11.4	12.0	12.8	14.5	17.0	21.0	27.7	27.4	32.7	38.7	48.4	60.4	76.4	96.0	121.0	193.0	307.0	478.0	—	—
100,000	4.8	5.2	5.7	6.0	6.4	7.2	8.5	10.5	11.8	13.7	16.4	19.4	24.2	30.2	38.2	48.0	60.6	96.6	153.0	239.0	380.0	—
90,000	4.3	4.7	5.1	5.4	5.8	6.5	7.7	9.4	10.7	12.3	14.7	17.4	21.8	27.2	34.4	43.2	54.6	87.0	138.0	215.0	342.0	—
80,000	3.8	4.1	4.6	4.8	5.1	5.8	6.8	8.4	9.5	11.0	13.1	15.5	19.4	24.2	30.5	38.4	48.5	77.3	123.0	191.0	304.0	483.0
70,000	3.4	3.6	4.0	4.2	4.5	5.1	6.0	7.3	8.3	9.6	11.5	13.6	16.9	21.1	26.7	33.6	42.4	67.6	107.0	167.0	266.0	423.0
60,000	2.9	3.1	3.4	3.6	3.8	4.3	5.1	6.1	6.3	7.1	8.2	9.8	11.6	14.5	18.1	22.9	28.8	36.4	58.0	92.0	144.0	228.0
50,000	2.4	2.6	2.9	3.0	3.2	3.6	4.3	5.2	5.9	6.9	8.2	9.7	12.1	15.1	19.1	24.0	30.3	48.3	76.7	120.0	190.0	302.0
40,000	1.9	2.1	2.3	2.4	2.5	2.9	3.4	4.2	4.7	5.6	6.5	7.7	9.7	12.1	15.3	19.2	24.1	38.6	61.4	95.6	152.0	242.0
30,000	1.4	1.6	1.7	1.8	1.9	2.2	2.6	3.1	3.6	4.1	4.9	5.8	7.3	9.1	11.6	14.4	18.2	29.0	46.0	71.7	114.0	181.0
20,000	1.0	1.0	1.1	1.2	1.3	1.5	1.7	2.1	2.8	2.7	3.3	3.9	4.8	6.0	7.6	9.6	12.1	19.3	30.7	47.8	76.0	121.0
10,000	0.5	0.5	0.6	0.6	0.6	0.7	0.9	1.1	1.2	1.4	1.6	1.9	2.4	3.0	3.8	4.8	6.1	9.7	15.3	23.9	38.0	60.4
9,000	0.4	0.5	0.5	0.5	0.6	0.7	0.8	0.9	1.1	1.2	1.5	1.7	2.2	2.7	3.4	4.2	5.5	8.7	13.8	21.5	34.2	54.4
8,000	0.4	0.4	0.5	0.5	0.6	0.6	0.7	0.8	1.0	1.1	1.3	1.6	1.9	2.4	3.1	3.8	4.9	7.7	12.3	19.1	30.4	48.3
7,000	0.3	0.4	0.4	0.4	0.5	0.5	0.6	0.7	0.8	1.0	1.2	1.4	1.7	2.1	2.7	3.4	4.2	6.8	10.7	16.7	26.6	42.3
6,000	0.3	0.3	0.3	0.4	0.4	0.4	0.5	0.6	0.7	0.8	1.0	1.2	1.5	1.8	2.3	2.9	3.6	5.8	9.2	14.4	22.8	36.2
5,000	0.2	0.3	0.3	0.3	0.3	0.4	0.4	0.5	0.6	0.7	0.8	1.0	1.2	1.5	1.9	2.4	3.0	4.8	7.7	12.0	19.0	30.2
4,000	0.2	0.2	0.2	0.2	0.3	0.3	0.3	0.4	0.5	0.6	0.7	0.8	1.0	1.2	1.5	1.9	2.4	3.9	6.1	9.6	15.2	24.2
3,000	0.1	0.2	0.2	0.2	0.2	0.3	0.3	0.4	0.4	0.5	0.6	0.7	0.8	1.2	1.4	1.8	2.3	4.5	7.2	11.4	18.1	28.1
2,000	0.1	0.1	0.1	0.1	0.1	0.2	0.2	0.3	0.3	0.4	0.5	0.6	0.8	1.0	1.2	1.5	1.9	3.1	4.8	7.6	12.1	19.1
1,000	0.1	0.1	0.1	0.1	0.1	0.1	0.1	0.1	0.1	0.1	0.2	0.2	0.2	0.3	0.4	0.5	0.6	1.0	1.5	2.4	3.8	6.0
900	—	0.1	0.1	0.1	0.1	0.1	0.1	0.1	0.1	0.1	0.2	0.2	0.2	0.3	0.4	0.6	0.9	1.4	2.2	3.4	5.4	—
800	—	—	0.1	0.1	0.1	0.1	0.1	0.1	0.1	0.1	0.1	0.2	0.2	0.2	0.3	0.4	0.6	0.8	1.2	1.9	3.0	4.8
700	—	—	—	—	0.1	0.1	0.1	0.1	0.1	0.1	0.1	0.2	0.2	0.3	0.3	0.4	0.7	1.1	1.7	2.7	4.2	—
600	—	—	—	—	—	0.1	0.1	0.1	0.1	0.1	0.1	0.1	0.2	0.2	0.3	0.4	0.6	0.9	1.4	2.3	3.6	—
500	—	—	—	—	—	—	0.1	0.1	0.1	0.1	0.1	0.1	0.2	0.2	0.2	0.3	0.5	0.8	1.2	1.9	3.0	—
400	—	—	—	—	—	—	—	0.1	0.1	0.1	0.1	0.1	0.1	0.1	0.2	0.2	0.4	0.6	1.0	1.5	2.4	—
300	—	—	—	—	—	—	—	—	—	—	0.1	0.1	0.1	0.1	0.1	0.2	0.3	0.5	0.7	1.1	1.8	—
200	—	—	—	—	—	—	—	—	—	—	—	—	0.1	0.1	0.1	0.1	0.2	0.3	0.5	0.8	1.2	—
100	—	—	—	—	—	—	—	—	—	—	—	—	—	0.1	0.1	0.1	0.2	0.3	0.5	0.8	1.2	—

* Solid Conductors. Other conductors are stranded.

Note 1—The above table gives voltage drops encountered in a single phase two-wire system. The voltage drops in other systems may be obtained through multiplication by appropriate factors listed below:

System for Which Voltage Drop is Desired	Multiplying Factors for Modification of Values in Table
Single Phase—3 Wire—Line to Line	1.00
Single Phase—3 Wire—Line to Neutral	0.50
Three Phase—3 Wire—Line to Line	0.866
Three Phase—4 Wire—Line to Line	0.866
Three Phase—4 Wire—Line to Neutral	0.50

Note 2—Allowable voltage drops for systems other than single phase, two wire cannot be used directly in the above table. Such drops should be modified through multiplication by the appropriate factor listed below. The voltage thus modified may then be used to obtain the proper wire size directly from the table.

System for Which Allowable Voltage Drop is Known	Multiplying Factor for Modification of Known Value to Permit Direct Use of Table
Single Phase—3 Wire—Line to Line	1.00
Single Phase—3 Wire—Line to Neutral	2.00
Three Phase—3 Wire—Line to Line	1.155
Three Phase—4 Wire—Line to Line	1.155
Three Phase—4 Wire—Line to Neutral	2.00

Note 3—The footage employed in the tabulated ampere feet refers to the length of run of the circuit rather than to the footage of individual conductor.

Note 4—The above table is figured at 60°C since this is an estimate of the average temperature which may be anticipated in service. The table may be used without significant error for conductor temperatures up to and including 75°C.

TABLE 3.57 Volts Drop for AL Conductor in Nonmagnetic Conduit—70 Percent PF

WIRE SIZE AWG or MCM	1000	900	800	750	700	600	500	400	350	300	250	4/0	3/0	2/0	1/0	1	2	4	6	8*	10*	12*
	Volts Drop																					
Amps Feet																						
600,000	38.1	39.9	42.1	43.4	44.8	47.9	53.0	60.8	66.2	73.3	83.0	93.3	101.0	134.0	163.0	198.0	242.0	370.0	—	—	—	—
400,000	30.5	31.9	33.6	34.7	35.9	38.3	42.4	48.5	52.9	58.7	66.4	74.6	80.8	107.0	130.0	158.0	194.0	296.0	456.0	—	—	—
300,000	22.8	23.9	25.2	26.1	26.9	28.7	31.8	36.5	39.7	44.0	49.8	55.9	60.6	80.4	97.8	119.0	145.0	222.0	342.0	—	—	—
200,000	16.2	16.9	17.4	17.9	18.2	19.2	21.2	24.4	26.4	29.3	33.2	37.3	40.4	53.6	65.2	79.2	96.8	148.0	228.0	348.0	—	—
100,000	7.6	8.0	8.4	8.7	9.0	9.6	10.6	12.2	13.2	14.7	16.8	18.6	20.2	26.8	32.6	39.6	48.4	74.0	114.0	174.0	273.0	430.0
90,000	6.9	7.2	7.6	7.8	8.1	8.6	9.5	11.0	11.9	13.2	14.9	16.8	18.2	24.1	29.3	35.6	43.6	66.6	103.0	157.0	246.0	387.0
80,000	6.1	6.4	6.7	7.0	7.2	7.7	8.5	9.7	10.6	11.7	13.3	14.9	16.2	21.4	26.1	31.7	38.7	59.2	91.2	139.0	219.0	344.0
70,000	5.3	5.6	5.9	6.1	6.3	6.7	7.4	8.5	9.3	10.3	11.6	13.1	14.1	18.8	22.8	27.7	33.9	51.8	79.8	122.0	191.0	301.0
60,000	4.6	4.8	5.1	5.2	5.4	5.8	6.4	7.3	8.0	8.8	10.0	11.2	12.1	16.1	19.6	23.8	29.1	44.4	68.4	105.0	164.0	258.0
50,000	3.8	4.0	4.2	4.3	4.5	4.8	5.3	6.1	6.6	7.3	8.3	9.3	10.1	13.4	16.3	19.8	24.2	37.0	57.0	87.2	137.0	215.0
40,000	3.1	3.2	3.4	3.5	3.6	3.8	4.2	4.9	5.3	5.9	6.6	7.5	8.1	10.7	13.0	15.8	19.4	29.6	45.6	69.5	109.0	172.0
30,000	2.3	2.4	2.6	2.6	2.7	2.9	3.2	3.7	4.0	4.4	5.0	5.6	6.1	8.0	9.8	11.9	14.5	22.2	34.2	52.5	81.9	129.0
20,000	1.6	1.6	1.7	1.7	1.8	1.9	2.1	2.4	2.6	2.9	3.3	3.7	4.0	5.4	6.5	7.9	9.7	14.9	22.8	34.9	54.6	86.0
10,000	0.8	0.8	0.8	0.9	0.9	1.0	1.1	1.2	1.3	1.5	1.7	1.9	2.0	2.7	3.3	4.0	4.8	7.4	11.4	17.4	27.3	43.0
9,000	0.7	0.7	0.8	0.8	0.8	0.9	1.0	1.1	1.2	1.3	1.5	1.7	1.8	2.4	2.9	3.6	4.4	6.7	10.3	15.7	24.6	38.7
8,000	0.6	0.6	0.7	0.7	0.7	0.8	0.9	1.0	1.1	1.2	1.3	1.5	1.6	2.1	2.5	3.2	3.9	5.9	9.1	13.9	21.9	34.4
7,000	0.5	0.5	0.6	0.6	0.6	0.7	0.7	0.9	0.9	1.0	1.2	1.3	1.4	1.9	2.3	2.8	3.4	5.2	8.0	12.2	19.1	30.1
6,000	0.5	0.5	0.5	0.5	0.5	0.6	0.6	0.7	0.8	0.9	1.0	1.1	1.2	1.8	2.0	2.4	2.9	4.4	6.8	10.5	16.4	25.8
5,000	0.4	0.4	0.4	0.4	0.5	0.5	0.6	0.8	0.7	0.7	0.8	0.9	1.0	1.3	1.6	2.0	2.4	3.7	5.7	8.7	13.7	21.6
4,000	0.3	0.3	0.3	0.4	0.4	0.4	0.4	0.5	0.5	0.6	0.7	0.8	0.8	1.1	1.3	1.6	1.9	3.0	4.6	7.0	10.9	17.2
3,000	0.2	0.2	0.3	0.3	0.3	0.3	0.3	0.4	0.4	0.5	0.6	0.6	0.6	0.8	1.0	1.2	1.5	2.2	3.4	5.3	8.2	12.9
2,000	0.2	0.2	0.2	0.2	0.2	0.2	0.2	0.2	0.3	0.3	0.3	0.4	0.4	0.5	0.7	0.8	1.0	1.6	2.3	3.5	5.5	8.6
1,000	0.1	0.1	0.1	0.1	0.1	0.1	0.1	0.1	0.1	0.2	0.2	0.2	0.2	0.3	0.3	0.4	0.5	0.7	1.1	1.7	2.7	4.3
900	0.1	0.1	0.1	0.1	0.1	0.1	0.1	0.1	0.1	0.1	0.2	0.2	0.2	0.2	0.3	0.4	0.4	0.7	1.0	1.6	2.5	3.9
800	0.1	0.1	0.1	0.1	0.1	0.1	0.1	0.1	0.1	0.1	0.1	0.1	0.2	0.2	0.3	0.3	0.4	0.6	0.9	1.4	2.2	3.4
700	0.1	0.1	0.1	0.1	0.1	0.1	0.1	0.1	0.1	0.1	0.1	0.1	0.1	0.1	0.2	0.2	0.3	0.5	0.8	1.2	1.9	3.0
600	0.1	0.1	0.1	0.1	0.1	0.1	0.1	0.1	0.1	0.1	0.1	0.1	0.1	0.2	0.2	0.2	0.3	0.4	0.7	1.1	1.6	2.6
500	—	—	—	—	0.1	0.1	0.1	0.1	0.1	0.1	0.1	0.1	0.1	0.1	0.1	0.2	0.2	0.3	0.5	0.9	1.4	2.2
400	—	—	—	—	—	—	—	0.1	0.1	0.1	0.1	0.1	0.1	0.1	0.1	0.1	0.2	0.3	0.5	0.7	1.1	1.7
300	—	—	—	—	—	—	—	—	—	—	—	0.1	0.1	0.1	0.1	0.1	0.2	0.3	0.5	0.8	1.3	2.0
200	—	—	—	—	—	—	—	—	—	—	—	—	—	—	0.1	0.1	0.1	0.2	0.3	0.5	0.8	1.3
100	—	—	—	—	—	—	—	—	—	—	—	—	—	—	—	0.1	0.1	0.1	0.2	0.3	0.4	0.9

* Solid Conductors. Other conductors are stranded.

Note 1—The above table gives voltage drops encountered in a single phase two-wire system. The voltage drops in other systems may be obtained through multiplication by appropriate factors listed below:

System for Which Voltage Drop is Desired	Multiplying Factor for Modification of Values in Table
Single Phase—3 Wire—Line to Line	1.00
Single Phase—3 Wire—Line to Neutral	0.50
Three Phase—3 Wire—Line to Line	0.868
Three Phase—4 Wire—Line to Line	0.868
Three Phase—4 Wire—Line to Neutral	0.50

Note 3—The footage employed in the tabulated ampere feet refers to the length of run of the circuit rather than to the footage of individual conductor.

Note 4—The above table is figured at 60°C since this is an estimate of the average temperature which may be anticipated in service. The table may be used without significant error for conductor temperatures up to and including 75°C.

Note 2—Allowable voltage drops for systems other than single phase, two wire cannot be used directly in the above table. Such drops should be modified through multiplication by the appropriate factor listed below. The voltage thus modified may then be used to obtain the proper wire size directly from the table.

System for Which Allowable Voltage Drop is Known	Multiplying Factor for Modification of Known Value to Permit Direct Use of Table
Single Phase—3 Wire—Line to Line	1.00
Single Phase—3 Wire—Line to Neutral	2.00
Three Phase—3 Wire—Line to Line	1.155
Three Phase—4 Wire—Line to Line	1.155
Three Phase—4 Wire—Line to Neutral	2.00

TABLE 3.58 Volts Drop for AL Conductor in Nonmagnetic Conduit—80 Percent PF

WIRE SIZE AWG or MCM	1000	900	800	750	700	600	500	400	350	300	250	4/0	3/0	2/0	1/0	1	2	4	6	8*	10*	12*
	Volts Drop																					
500,000	36.5	38.3	40.8	42.2	43.9	48.0	53.1	61.9	67.7	75.8	86.8	98.7	119.0	145.0	177.0	217.0	267.0	413.0	—	—	—	—
400,000	29.2	30.6	32.6	33.8	35.1	38.4	42.4	49.5	54.1	60.7	69.4	79.3	95.2	116.0	142.0	174.0	214.0	330.0	—	—	—	—
300,000	21.9	23.0	24.5	25.3	26.3	28.8	31.8	37.1	40.6	45.5	52.1	59.2	71.4	87.0	106.0	130.0	160.0	248.0	385.0	—	—	—
200,000	14.6	15.3	16.3	16.9	17.6	19.2	21.2	24.8	27.1	30.4	34.7	39.4	47.6	58.0	70.8	86.8	107.0	165.0	257.0	394.0	—	—
100,000	7.3	7.7	8.2	8.4	8.8	9.6	10.6	12.4	13.5	15.2	17.4	19.7	23.8	29.0	35.4	43.4	53.4	82.6	128.0	197.0	310.0	490.0
90,000	6.6	6.9	7.3	7.6	7.9	8.6	9.6	11.1	12.2	13.6	15.6	17.7	21.4	26.1	31.9	39.0	48.1	74.3	116.0	177.0	279.0	441.0
80,000	5.8	6.1	6.5	6.8	7.0	7.7	8.5	9.9	10.8	12.1	13.9	15.8	19.0	23.2	28.3	34.7	42.7	66.1	103.0	159.0	248.0	392.0
70,000	5.1	5.4	5.7	5.9	6.1	6.7	7.4	8.7	9.5	10.6	12.1	13.8	16.7	20.3	24.8	30.4	37.4	57.8	89.9	138.0	217.0	343.0
60,000	4.4	4.6	4.9	5.1	5.3	5.8	6.3	7.4	8.1	9.1	10.4	11.8	14.3	17.4	21.2	26.0	32.0	49.6	77.1	118.0	186.0	294.0
50,000	3.7	3.8	4.1	4.2	4.4	4.8	5.3	6.2	6.8	7.6	8.7	9.9	11.9	14.5	17.7	21.7	26.7	41.3	64.2	96.6	155.0	245.0
40,000	2.9	3.1	3.3	3.4	3.5	3.8	4.2	5.0	5.4	6.1	6.9	7.9	9.5	11.6	14.2	17.4	21.4	33.0	51.4	78.8	124.0	196.0
30,000	2.2	2.3	2.5	2.5	2.6	2.9	3.2	3.7	4.1	4.6	5.2	5.9	7.1	8.7	10.6	13.0	16.0	24.8	38.5	59.1	93.0	147.0
20,000	1.5	1.5	1.6	1.7	1.8	1.9	2.1	2.5	2.7	3.0	3.5	3.9	4.8	5.8	7.1	8.7	10.7	16.5	25.7	39.4	62.0	98.0
10,000	0.7	0.8	0.8	0.8	0.9	1.0	1.1	1.2	1.4	1.5	1.7	2.0	2.4	2.9	3.5	4.3	5.3	8.3	12.8	19.7	31.0	49.0
9,000	0.7	0.7	0.7	0.8	0.8	0.9	1.0	1.1	1.2	1.4	1.6	1.8	2.1	2.6	3.2	3.9	4.8	7.4	11.6	17.7	27.9	44.1
8,000	0.6	0.6	0.7	0.7	0.7	0.8	0.9	1.0	1.1	1.2	1.4	1.6	1.9	2.3	2.8	3.5	4.3	6.6	10.3	15.8	24.8	39.2
7,000	0.5	0.5	0.6	0.6	0.6	0.7	0.7	0.9	1.0	1.1	1.2	1.4	1.7	2.0	2.5	3.0	3.7	5.8	8.9	13.8	21.7	34.3
6,000	0.4	0.5	0.5	0.5	0.5	0.6	0.6	0.7	0.9	0.9	1.0	1.2	1.4	1.7	2.1	2.6	3.2	5.0	7.7	11.8	18.6	29.4
5,000	0.4	0.4	0.4	0.4	0.4	0.5	0.5	0.6	0.7	0.8	0.9	1.0	1.2	1.5	1.8	2.2	2.7	4.1	6.4	9.9	15.5	24.5
4,000	0.3	0.3	0.3	0.3	0.4	0.4	0.4	0.5	0.6	0.7	0.8	1.0	1.2	1.4	1.7	2.1	2.6	3.9	6.1	9.3	14.4	19.6
3,000	0.2	0.2	0.3	0.3	0.3	0.3	0.3	0.4	0.4	0.5	0.6	0.7	0.9	1.1	1.3	1.6	2.3	3.9	5.9	9.3	14.7	
2,000	0.2	0.2	0.2	0.2	0.2	0.2	0.2	0.3	0.3	0.4	0.4	0.5	0.6	0.7	0.9	1.1	1.7	2.6	3.9	6.2	9.8	
1,000	0.1	0.1	0.1	0.1	0.1	0.1	0.1	0.1	0.1	0.2	0.2	0.2	0.3	0.4	0.4	0.5	0.8	1.3	2.0	3.1	4.9	
900	0.1	0.1	0.1	0.1	0.1	0.1	0.1	0.1	0.1	0.1	0.2	0.2	0.2	0.3	0.3	0.4	0.5	0.7	1.2	1.8	2.8	4.4
800	0.1	0.1	0.1	0.1	0.1	0.1	0.1	0.1	0.1	0.1	0.1	0.2	0.2	0.2	0.3	0.4	0.4	0.7	1.0	1.6	2.5	3.9
700	0.1	0.1	0.1	0.1	0.1	0.1	0.1	0.1	0.1	0.1	0.1	0.1	0.2	0.2	0.3	0.3	0.4	0.6	0.9	1.4	2.2	3.4
600	—	0.1	0.1	0.1	0.1	0.1	0.1	0.1	0.1	0.1	0.1	0.1	0.1	0.2	0.2	0.3	0.3	0.5	0.8	1.2	1.9	2.9
500	—	—	—	—	—	0.1	0.1	0.1	0.1	0.1	0.1	0.1	0.1	0.2	0.2	0.3	0.4	0.6	1.0	1.6	2.5	
400	—	—	—	—	—	—	0.1	0.1	0.1	0.1	0.1	0.1	0.1	0.1	0.2	0.2	0.3	0.5	0.8	1.2	2.0	
300	—	—	—	—	—	—	—	0.1	0.1	0.1	0.1	0.1	0.1	0.1	0.1	0.2	0.3	0.4	0.6	0.9	1.5	
200	—	—	—	—	—	—	—	—	—	—	—	—	0.1	0.1	0.1	0.1	0.1	0.2	0.3	0.4	0.6	
100	—	—	—	—	—	—	—	—	—	—	—	—	—	0.1	0.1	0.1	0.1	0.2	0.3	0.4	0.6	

* Solid Conductors. Other conductors are stranded.

Note 1—The above table gives voltage drops encountered in a single phase two-wire system. The voltage drops in other systems may be obtained through multiplication by appropriate factors listed below:

System for Which Voltage Drop is Desired	Multiplying Factor for Modification of Values in Table
Single Phase—3 Wire—Line to Line	1.00
Single Phase—3 Wire—Line to Neutral	0.50
Three Phase—3 Wire—Line to Line	0.866
Three Phase—4 Wire—Line to Line	0.866
Three Phase—4 Wire—Line to Neutral	0.50

Note 3—The footage employed in the tabulated ampere feet refers to the length of run of the circuit rather than to the footage of individual conductor.

Note 4—The above table is figured at 60°C since this is an estimate of the average temperature which may be anticipated in service. The table may be used without significant error for conductor temperatures up to and including 75°C.

Note 2—Allowable voltage drops for systems other than single phase, two wire cannot be used directly in the above table. Such drops should be modified through multiplication by the appropriate factor listed below. The voltage thus modified may then be used to obtain the proper wire size directly from the table.

System for Which Allowable Voltage Drop is Known	Multiplying Factor for Modification of Known Value to Permit Direct Use of Table
Single Phase—3 Wire—Line to Line	1.00
Single Phase—3 Wire—Line to Neutral	2.00
Three Phase—3 Wire—Line to Line	1.155
Three Phase—4 Wire—Line to Line	1.155
Three Phase—4 Wire—Line to Neutral	2.00

TABLE 3.59 Volts Drop for AL Conductor in Nonmagnetic Conduit—90 Percent PF

WIRE SIZE AWG or MCM	1000	900	800	750	700	600	500	400	350	300	250	4/0	3/0	2/0	1/0	1	2	4	6	8*	10*	12*		
	Volts Drop																							
Amperes Feet																								
500,000	33.0	35.1	37.8	39.4	41.2	45.7	51.5	61.1	67.5	76.5	88.7	102.0	125.0	153.0	189.0	234.0	290.0	454.0	—	—	—	—		
400,000	26.4	28.1	30.2	31.5	32.9	36.5	41.2	48.8	54.0	61.2	71.0	81.5	100.0	122.0	151.0	187.0	232.0	353.0	—	—	—	—		
300,000	19.8	21.1	22.7	23.5	24.7	27.4	30.9	36.6	40.5	45.9	53.3	61.2	75.0	91.8	113.0	141.0	174.0	272.0	427.0	—	—	—		
200,000	13.2	14.1	15.1	15.8	16.5	18.5	20.6	24.4	27.0	30.6	35.5	40.8	50.0	61.2	75.5	93.6	116.0	182.0	284.0	438.0	—	—		
100,000	6.6	7.0	7.6	7.9	8.2	9.1	10.3	12.2	13.5	15.3	17.7	20.4	25.0	30.6	37.8	46.8	58.0	90.8	142.0	219.0	346.0	—		
90,000	5.9	6.3	6.8	7.1	7.4	8.2	9.3	11.0	12.2	13.8	16.0	18.4	22.5	27.5	34.0	42.1	52.2	81.7	128.0	197.0	312.0	494.0		
80,000	5.3	5.6	6.1	6.3	6.6	7.3	8.2	9.8	10.8	12.2	14.2	16.3	20.0	24.5	30.2	37.4	46.4	72.6	114.0	175.0	277.0	438.0		
70,000	4.6	4.9	5.3	5.5	5.8	6.4	7.2	8.6	9.5	10.7	12.4	14.3	17.5	21.4	26.4	32.8	40.6	63.5	99.6	153.0	242.0	384.0		
60,000	3.9	4.2	4.5	4.7	4.9	5.5	6.2	7.3	8.1	9.2	10.6	12.2	15.0	18.4	22.5	28.1	34.8	54.4	85.4	132.0	208.0	325.0		
50,000	3.3	3.5	3.8	3.9	4.1	4.6	5.2	6.1	6.8	7.7	8.9	10.2	12.5	15.3	18.9	23.4	29.0	45.4	71.1	109.0	173.0	274.0		
40,000	2.6	2.8	3.0	3.2	3.3	3.7	4.1	4.9	5.4	6.1	7.1	8.2	10.0	12.2	15.1	18.7	23.2	36.3	56.8	87.6	138.0	219.0		
30,000	2.0	2.1	2.3	2.4	2.5	2.7	3.1	3.7	4.1	4.6	5.3	6.1	7.5	9.2	11.3	14.1	17.4	27.2	42.7	65.7	104.0	165.0		
20,000	1.3	1.4	1.5	1.6	1.7	1.9	2.1	2.4	2.7	3.1	3.6	4.1	5.0	6.1	7.5	9.4	11.6	18.2	28.4	43.8	69.2	110.0		
10,000	0.7	0.7	0.8	0.8	0.8	0.9	1.0	1.2	1.4	1.5	1.8	2.0	2.5	3.1	3.8	4.7	5.8	9.1	14.2	21.9	34.8	54.9		
9,000	0.6	0.6	0.7	0.7	0.7	0.8	0.9	1.1	1.2	1.4	1.6	1.8	2.3	2.8	3.4	4.2	5.2	8.2	12.8	19.7	31.2	49.4		
8,000	0.5	0.6	0.6	0.6	0.6	0.7	0.8	1.0	1.1	1.2	1.4	1.6	2.0	2.5	3.0	3.7	4.6	7.3	11.4	17.5	27.7	43.8		
7,000	0.5	0.5	0.5	0.5	0.5	0.6	0.7	0.9	1.0	1.1	1.2	1.4	1.8	2.1	2.6	3.3	4.1	6.4	10.0	15.3	24.2	38.4		
6,000	0.4	0.4	0.5	0.5	0.5	0.6	0.6	0.7	0.8	0.9	1.1	1.2	1.5	1.8	2.3	2.8	3.5	5.4	8.5	13.2	20.8	32.9		
5,000	0.3	0.4	0.4	0.4	0.4	0.5	0.5	0.6	0.7	0.8	0.9	1.0	1.3	1.5	1.9	2.3	2.9	4.5	7.1	10.9	17.3	27.4		
4,000	0.3	0.3	0.3	0.3	0.3	0.4	0.4	0.5	0.5	0.6	0.7	0.8	1.0	1.2	1.5	1.9	2.3	3.5	5.7	8.8	13.8	21.9		
3,000	0.2	0.2	0.2	0.2	0.2	0.3	0.3	0.4	0.4	0.5	0.5	0.6	0.8	0.9	1.1	1.4	1.7	2.7	4.3	6.5	10.4	16.5		
2,000	0.1	0.1	0.2	0.2	0.2	0.2	0.2	0.3	0.3	0.4	0.4	0.5	0.6	0.7	0.9	1.2	1.8	2.8	4.4	6.9	11.0	17.0		
1,000	0.1	0.1	0.1	0.1	0.1	0.1	0.1	0.1	0.1	0.2	0.2	0.2	0.3	0.4	0.5	0.6	0.9	1.4	2.2	3.5	5.5	9.0		
900	0.1	0.1	0.1	0.1	0.1	0.1	0.1	0.1	0.1	0.1	0.1	0.1	0.1	0.1	0.2	0.2	0.3	0.4	0.5	0.8	1.3	2.0	3.1	4.9
800	0.1	0.1	0.1	0.1	0.1	0.1	0.1	0.1	0.1	0.1	0.1	0.1	0.1	0.2	0.2	0.3	0.3	0.4	0.5	0.7	1.1	1.8	2.8	4.4
700	0.1	0.1	0.1	0.1	0.1	0.1	0.1	0.1	0.1	0.1	0.1	0.1	0.1	0.2	0.2	0.3	0.3	0.4	0.6	1.0	1.5	2.4	3.8	
600	—	—	0.1	0.1	0.1	0.1	0.1	0.1	0.1	0.1	0.1	0.1	0.1	0.2	0.2	0.2	0.3	0.4	0.5	0.9	1.3	2.1	3.3	
500	—	—	—	—	—	0.1	0.1	0.1	0.1	0.1	0.1	0.1	0.1	0.2	0.2	0.2	0.3	0.5	0.7	1.1	1.7	2.7	4.2	
400	—	—	—	—	—	—	—	0.1	0.1	0.1	0.1	0.1	0.1	0.1	0.1	0.2	0.2	0.4	0.6	0.9	1.4	2.2	3.5	
300	—	—	—	—	—	—	—	—	—	0.1	0.1	0.1	0.1	0.1	0.1	0.1	0.2	0.3	0.4	0.7	1.0	1.7	2.7	
200	—	—	—	—	—	—	—	—	—	—	—	—	—	—	0.1	0.1	0.1	0.1	0.2	0.3	0.4	0.7	1.1	
100	—	—	—	—	—	—	—	—	—	—	—	—	—	—	—	—	0.1	0.1	0.1	0.1	0.2	0.4	0.6	

* Solid Conductors. Other conductors are stranded.

Note 1—The above table gives voltage drops encountered in a single phase two-wire system. The voltage drops in other systems may be obtained through multiplication by appropriate factors listed below:

System for Which Voltage Drop is Desired	Multiplying Factor for Modification of Values in Table
Single Phase—3 Wire—Line to Line	1.00
Single Phase—3 Wire—Line to Neutral	0.50
Three Phase—3 Wire—Line to Line	0.866
Three Phase—4 Wire—Line to Line	0.866
Three Phase—4 Wire—Line to Neutral	0.50

Note 2—Allowable voltage drops for systems other than single phase, two wire cannot be used directly in the above table. Such drops should be obtained through multiplication by the appropriate factor listed below. The voltage thus modified may then be used to obtain the proper wire size directly from the table.

System for Which Allowable Voltage Drop is Known	Multiplying Factor for Modification of Known Value to Permit Direct Use of Table
Single Phase—3 Wire—Line to Line	1.00
Single Phase—3 Wire—Line to Neutral	2.00
Three Phase—3 Wire—Line to Line	1.155
Three Phase—4 Wire—Line to Line	1.155
Three Phase—4 Wire—Line to Neutral	2.00

Note 3—The footage employed in the tabulated ampere feet refers to the length of run of the circuit rather than to the footage of individual conductor.

Note 4—The above table is figured at 60°C since this is an estimate of the average temperature which may be anticipated in service. The table may be used without significant error for conductor temperatures up to and including 75°C.

TABLE 3.60 Volts Drop for AL Conductor in Nonmagnetic Conduit—95 Percent PF

WIRE SIZE AWG or MCM	1000	900	800	750	700	600	500	400	350	300	250	4/0	3/0	2/0	1/0	1	2	4	6	8*	10*	12*
	Volts Drop																					
500,000	30.0	32.2	34.9	36.6	38.5	43.0	49.2	59.3	66.9	75.3	88.1	103.0	126.0	156.0	194.0	241.0	301.0	473.0	—	—	—	—
400,000	24.0	25.6	27.9	29.3	30.8	34.4	39.4	47.4	52.7	60.3	70.5	82.4	100.0	125.0	155.0	193.0	241.0	378.0	—	—	—	—
300,000	18.0	19.3	21.0	22.0	23.1	25.8	29.5	35.5	39.5	45.2	52.9	61.8	75.6	93.6	116.0	145.0	181.0	284.0	447.0	—	—	—
200,000	12.0	12.9	14.0	14.6	15.4	17.2	19.7	23.7	26.4	30.2	35.3	41.2	50.4	62.4	77.6	96.4	120.0	189.0	398.0	460.0	—	—
100,000	6.0	6.4	7.0	7.3	7.7	8.6	9.8	11.8	13.2	15.1	17.6	20.6	25.2	31.2	38.8	48.2	60.2	94.6	149.0	230.0	364.0	—
90,000	5.4	5.8	6.3	6.6	6.9	7.7	8.9	10.7	11.9	13.6	15.9	18.5	22.7	28.1	35.0	43.3	54.2	85.1	134.0	207.0	328.0	—
80,000	4.8	5.2	5.6	5.9	6.2	6.9	7.9	9.5	10.5	12.1	14.1	16.5	20.2	24.9	31.0	38.5	48.2	75.6	119.0	184.0	291.0	462.0
70,000	4.2	4.6	4.9	5.1	5.4	6.0	6.9	8.3	9.2	10.6	12.3	14.4	17.6	21.8	27.2	33.7	42.2	66.2	104.0	161.0	255.0	404.0
60,000	3.6	3.9	4.2	4.4	4.6	5.2	5.9	7.1	7.9	9.0	10.6	12.4	14.4	18.1	22.3	28.9	36.1	55.8	89.3	139.0	219.0	346.0
60,000	3.0	3.2	3.5	3.7	3.9	4.3	4.9	5.9	6.6	7.5	8.8	10.3	12.6	15.6	19.4	24.1	30.1	47.3	74.4	115.0	182.0	289.0
40,000	2.4	2.6	2.8	2.9	3.1	3.4	3.8	4.7	5.3	6.0	7.1	8.2	10.0	12.5	15.5	19.3	24.1	37.8	59.6	92.0	146.0	231.0
30,000	1.8	1.9	2.1	2.2	2.3	2.6	3.0	3.6	4.0	4.5	5.3	6.2	7.6	9.4	11.6	14.5	18.1	28.4	44.7	69.0	109.0	173.0
20,000	1.2	1.3	1.4	1.5	1.6	1.7	2.0	2.4	2.6	3.0	3.5	4.1	5.0	6.2	7.8	9.6	12.0	18.9	30.8	46.0	72.8	115.0
10,000	0.6	0.6	0.7	0.7	0.8	0.9	1.0	1.2	1.3	1.5	1.8	2.1	2.6	3.1	3.9	4.8	6.0	9.5	14.9	23.0	36.4	57.7
9,000	0.9	0.6	0.6	0.7	0.7	0.8	0.9	1.1	1.2	1.4	1.6	1.9	2.3	2.8	3.5	4.3	5.4	8.5	13.4	20.7	32.8	52.0
8,000	0.5	0.5	0.5	0.6	0.6	0.7	0.8	1.0	1.1	1.2	1.4	1.7	2.0	2.5	3.1	3.9	4.8	7.6	11.9	18.4	29.1	46.2
7,000	0.4	0.5	0.5	0.5	0.5	0.6	0.7	0.8	0.9	1.1	1.2	1.4	1.8	2.2	2.8	3.4	4.2	6.6	10.4	16.1	25.5	40.4
6,000	0.4	0.4	0.4	0.4	0.5	0.5	0.6	0.7	0.8	0.9	1.1	1.2	1.5	1.9	2.3	2.9	3.6	5.7	8.9	13.8	21.8	34.6
5,000	0.3	0.3	0.4	0.4	0.4	0.4	0.5	0.6	0.7	0.8	0.9	1.0	1.3	1.6	1.9	2.4	3.0	4.7	7.4	11.5	18.2	28.9
4,000	0.2	0.3	0.3	0.3	0.3	0.3	0.4	0.5	0.5	0.6	0.7	0.8	1.0	1.3	1.6	1.9	2.4	3.8	6.0	9.2	14.6	23.1
3,000	0.2	0.2	0.2	0.2	0.2	0.3	0.3	0.4	0.4	0.5	0.5	0.6	0.8	0.9	1.2	1.5	1.8	2.8	4.5	6.9	10.9	17.3
2,000	0.1	0.1	0.1	0.2	0.2	0.2	0.2	0.2	0.3	0.3	0.4	0.4	0.5	0.6	0.8	1.0	1.2	1.9	4.0	4.6	7.3	11.5
1,000	0.1	0.1	0.1	0.1	0.1	0.1	0.1	0.1	0.1	0.1	0.2	0.2	0.3	0.3	0.4	0.5	0.6	1.0	1.5	2.3	3.6	5.8
900	0.1	0.1	0.1	0.1	0.1	0.1	0.1	0.1	0.1	0.1	0.2	0.2	0.2	0.3	0.4	0.4	0.5	0.9	1.3	2.1	3.3	5.2
800	0.1	0.1	0.1	0.1	0.1	0.1	0.1	0.1	0.1	0.1	0.1	0.2	0.2	0.3	0.3	0.4	0.5	0.8	1.2	1.8	2.9	4.6
700	—	0.1	0.1	0.1	0.1	0.1	0.1	0.1	0.1	0.1	0.1	0.1	0.2	0.2	0.3	0.3	0.4	0.7	1.0	1.6	2.6	4.0
600	—	—	—	—	0.1	0.1	0.1	0.1	0.1	0.1	0.1	0.1	0.2	0.2	0.2	0.3	0.4	0.6	0.9	1.4	2.2	3.5
500	—	—	—	—	—	—	0.1	0.1	0.1	0.1	0.1	0.1	0.1	0.1	0.2	0.2	0.3	0.5	0.7	1.2	1.8	2.9
400	—	—	—	—	—	—	—	0.1	0.1	0.1	0.1	0.1	0.1	0.1	0.1	0.2	0.2	0.4	0.6	0.9	1.5	2.3
300	—	—	—	—	—	—	—	—	0.1	0.1	0.1	0.1	0.1	0.1	0.1	0.2	0.2	0.3	0.5	0.7	1.1	1.7
200	—	—	—	—	—	—	—	—	—	—	—	—	—	0.1	0.1	0.1	0.1	0.2	0.4	0.5	0.7	1.2
100	—	—	—	—	—	—	—	—	—	—	—	—	—	—	0.1	0.1	0.1	0.2	0.2	0.2	0.4	0.6

* Solid Conductors. Other conductors are stranded.

Note 1.—The above table gives voltage drops encountered in a single phase two-wire system. The voltage drops in other systems may be obtained through multiplication by appropriate factors listed below:

System for Which Voltage Drop is Desired	Multiplying Factor for Modification of Values in Table
Single Phase—3 Wire—Line to Line	1.00
Single Phase—3 Wire—Line to Neutral	0.50
Three Phase—3 Wire—Line to Line	0.866
Three Phase—4 Wire—Line to Line	0.866
Three Phase—4 Wire—Line to Neutral	0.50

Note 3.—The footage employed in the tabulated ampere feet refers to the length of run of the circuit rather than to the footage of individual conductor.

Note 4.—The above table is figured at 60°C since this is an estimate of the average temperature which may be anticipated in service. The table may be used without significant error for conductor temperatures up to and including 76°C.

Note 2.—Allowable voltage drops for systems other than single phase, two wire cannot be used directly in the above table. Such drops should be modified through multiplication by the appropriate factor listed below. The voltage thus modified may then be used to obtain the proper wire size directly from the table.

System for Which Allowable Voltage Drop is Known	Multiplying Factor for Modification of Known Value to Permit Direct Use of Table
Single Phase—3 Wire—Line to Line	1.00
Single Phase—3 Wire—Line to Neutral	2.00
Three Phase—3 Wire—Line to Line	1.155
Three Phase—4 Wire—Line to Line	1.155
Three Phase—4 Wire—Line to Neutral	2.00

TABLE 3.61 Volts Drop for AL Conductor in Nonmagnetic Conduit—100 Percent PF

WIRE SIZE AWG or MCM	1000	900	800	750	700	600	500	400	350	300	250	4/0	3/0	2/0	1/0	1	2	4	6	8*	10*	12*	
	Volts Drop																						
Amperes Feet																							
600,000	20.7	22.8	25.6	27.3	29.2	33.9	40.4	60.7	57.5	67.2	80.5	95.9	120.0	151.0	191.0	240.0	303.0	483.0	—	—	—	—	
400,000	15.6	18.2	20.5	21.8	23.4	27.1	32.3	46.6	45.0	53.7	64.4	76.8	96.0	121.0	153.0	192.0	241.0	386.0	—	—	—	—	
300,000	12.4	13.7	15.3	16.4	17.6	20.3	24.3	30.4	34.5	40.6	48.3	57.6	72.0	90.6	115.0	144.0	182.0	290.0	460.0	—	—	—	
200,000	8.2	9.1	10.2	10.9	11.7	13.5	16.2	20.3	23.0	26.9	32.2	38.4	48.0	60.4	76.4	96.0	121.0	193.0	307.0	478.0	—	—	
100,000	4.1	4.6	5.1	5.5	5.8	6.8	8.1	10.1	11.5	13.4	16.1	19.2	24.0	30.2	38.2	48.0	60.6	96.6	153.0	239.0	380.0	—	
90,000	3.7	4.1	4.6	4.9	5.3	6.1	7.3	9.1	10.3	12.1	14.5	17.3	21.6	27.2	34.4	43.2	54.6	87.0	138.0	215.0	342.0	—	
80,000	3.3	3.7	4.1	4.4	4.7	5.4	6.5	8.1	9.2	10.8	12.9	15.3	19.2	24.2	30.5	38.4	48.5	77.3	123.0	191.0	304.0	483.0	
70,000	2.9	3.2	3.6	3.8	4.1	4.8	5.7	7.1	8.1	9.4	11.3	13.4	16.8	21.1	27.6	33.6	42.4	67.6	107.0	167.0	266.0	423.0	
60,000	2.5	2.7	3.1	3.3	3.5	4.1	4.9	6.1	6.9	8.1	9.7	11.5	14.4	18.1	22.9	28.8	36.4	58.0	92.0	144.0	228.0	362.0	
50,000	2.1	2.3	2.6	2.7	2.9	3.4	4.0	5.1	5.8	6.7	8.1	9.6	12.0	15.1	19.1	24.0	30.3	48.3	76.7	120.0	190.0	302.0	
40,000	1.7	1.8	2.1	2.2	2.3	2.7	3.2	4.1	4.6	5.4	6.4	7.7	9.6	12.1	15.3	19.2	24.1	38.6	61.4	95.6	152.0	242.0	
30,000	1.2	1.4	1.6	1.6	1.8	2.0	2.4	3.0	3.5	4.1	4.8	5.8	7.2	9.1	11.5	14.4	18.2	29.0	45.0	71.7	114.0	181.0	
20,000	0.8	0.9	1.0	1.1	1.2	1.4	1.6	2.0	2.3	2.7	3.2	3.8	4.8	6.0	7.6	9.6	12.1	19.3	30.7	47.8	76.0	121.0	
10,000	0.4	0.5	0.5	0.6	0.6	0.7	0.8	1.0	1.2	1.3	1.6	1.9	2.4	3.0	3.8	4.8	6.1	9.7	15.3	23.9	38.0	60.4	
9,000	0.4	0.4	0.5	0.5	0.5	0.6	0.7	0.9	1.0	1.2	1.5	1.7	2.2	2.7	3.4	4.3	5.5	8.7	13.8	21.5	34.2	54.4	
8,000	0.3	0.4	0.4	0.4	0.5	0.5	0.7	0.8	0.9	1.1	1.3	1.5	1.9	2.4	3.1	3.8	4.9	7.7	12.3	19.1	30.4	48.3	
7,000	0.3	0.3	0.4	0.4	0.4	0.5	0.6	0.7	0.8	0.9	1.1	1.3	1.7	2.1	2.8	3.4	4.2	6.8	10.7	16.7	26.6	42.3	
6,000	0.3	0.3	0.3	0.3	0.4	0.4	0.5	0.6	0.7	0.8	1.0	1.2	1.4	1.8	2.3	2.9	3.6	5.8	9.2	14.4	22.8	36.2	
6,000	0.2	0.2	0.3	0.3	0.3	0.3	0.4	0.6	0.6	0.7	0.8	1.0	1.2	1.5	1.9	2.4	3.0	4.8	7.7	12.0	19.0	30.2	
4,000	0.2	0.2	0.2	0.2	0.2	0.3	0.3	0.4	0.5	0.5	0.6	0.7	1.0	1.2	1.5	1.9	2.4	3.8	6.1	9.5	15.2	24.2	
3,000	0.1	0.1	0.2	0.2	0.2	0.2	0.3	0.4	0.4	0.5	0.6	0.7	0.9	1.2	1.4	1.8	2.8	4.6	7.2	11.4	18.1	28.2	
2,000	0.1	0.1	0.1	0.1	0.1	0.1	0.2	0.2	0.2	0.3	0.3	0.4	0.5	0.6	0.8	1.0	1.2	1.9	3.1	4.8	7.6	12.1	
1,000	—	0.1	0.1	0.1	0.1	0.1	0.1	0.1	0.1	0.1	0.2	0.2	0.2	0.3	0.4	0.5	0.6	1.0	1.5	2.4	3.8	6.0	
900	—	—	0.1	0.1	0.1	0.1	0.1	0.1	0.1	0.1	0.2	0.2	0.2	0.3	0.3	0.4	0.6	0.9	1.4	2.2	3.4	5.4	
800	—	—	—	—	0.1	0.1	0.1	0.1	0.1	0.1	0.1	0.2	0.2	0.2	0.3	0.4	0.5	0.8	1.2	1.9	3.0	4.8	
700	—	—	—	—	—	0.1	0.1	0.1	0.1	0.1	0.1	0.1	0.1	0.2	0.2	0.3	0.3	0.4	0.7	1.1	1.7	2.7	4.2
600	—	—	—	—	—	—	0.1	0.1	0.1	0.1	0.1	0.1	0.1	0.1	0.2	0.2	0.3	0.4	0.6	0.9	1.4	2.3	3.6
500	—	—	—	—	—	—	—	0.1	0.1	0.1	0.1	0.1	0.1	0.1	0.2	0.2	0.3	0.5	0.8	1.2	1.9	3.0	
400	—	—	—	—	—	—	—	—	0.1	0.1	0.1	0.1	0.1	0.1	0.2	0.2	0.3	0.6	1.0	1.5	2.4	3.6	
300	—	—	—	—	—	—	—	—	—	0.1	0.1	0.1	0.1	0.1	0.1	0.2	0.3	0.5	0.7	1.1	1.7	2.7	
200	—	—	—	—	—	—	—	—	—	—	—	—	—	—	0.1	0.1	0.1	0.2	0.3	0.5	0.8	1.2	
100	—	—	—	—	—	—	—	—	—	—	—	—	—	—	—	0.1	0.1	0.1	0.2	0.3	0.5	0.8	

* Solid Conductors. Other conductors are stranded.

Note 1—The above table gives voltage drops encountered in a single phase two-wire system. The voltage drops in other systems may be obtained through multiplication by appropriate factors listed below:

System for Which Voltage Drop is Desired	Multiplying Factor for Modification of Values in Table
Single Phase—3 Wires—Line to Line	1.00
Single Phase—3 Wires—Line to Neutral	0.50
Three Phase—3 Wires—Line to Line	0.866
Three Phase—4 Wires—Line to Line	0.866
Three Phase—4 Wires—Line to Neutral	0.50

Note 3—The footage employed in the tabulated ampere feet refers to the length of run of the circuit rather than to the footage of individual conductor.

Note 4—The above table is figured at 60°C since this is an estimate of the average temperature which may be anticipated in service. The table may be used without significant error for conductor temperatures up to and including 75°C.

Note 2—Allowable voltage drops for systems other than single phase, two wire cannot be used directly in the above table. Such drops should be modified through multiplication by the appropriate factor listed below. The voltage thus modified may then be used to obtain the proper wire size directly from the table.

System for Which Allowable Voltage Drop is Known	Multiplying Factor for Modification of Known Value to Permit Direct Use of Table
Single Phase—3 Wires—Line to Line	1.00
Single Phase—3 Wires—Line to Neutral	2.00
Three Phase—3 Wires—Line to Line	1.155
Three Phase—4 Wires—Line to Line	1.155
Three Phase—4 Wires—Line to Neutral	2.00



TABLE 3.62 Volts Drop for CU Conductor—Direct Current

WIRE SIZE AWG or MCM	Volts Drop																								
	1000	900	800	750	700	600	500	400	350	300	250	4/0	3/0	2/0	1/0	1	2	4	6	8*	10*	12*	14*		
500,000	13.0	14.0	16.0	17.0	18.0	21.0	26.0	32.0	36.0	42.0	50.0	59.0	76.0	96.0	121.0	152.0	192.0	306.0	483.0	—	—	—	—	—	—
400,000	10.4	11.2	12.8	13.6	14.4	16.8	20.8	25.6	29.8	33.6	40.0	47.2	60.8	76.8	96.8	122.0	153.0	244.0	386.0	—	—	—	—	—	—
300,000	7.8	8.4	9.6	10.2	10.8	12.6	15.6	19.2	21.6	25.2	30.0	36.4	46.6	57.6	72.6	91.2	115.0	183.0	290.0	—	—	—	—	—	—
200,000	5.2	5.6	6.4	6.8	7.2	8.4	10.4	12.8	14.4	16.8	20.0	24.0	30.4	38.4	48.4	59.4	76.4	122.0	190.0	—	—	—	—	—	—
100,000	2.6	2.8	3.2	3.4	3.6	4.2	5.2	6.4	7.2	8.4	10.0	11.8	16.2	19.2	24.2	30.4	38.4	61.2	96.8	—	—	—	—	—	—
90,000	2.3	2.5	2.9	3.1	3.2	3.8	4.7	5.8	6.6	7.6	9.0	10.6	13.7	17.3	21.8	27.4	34.6	55.0	87.0	—	—	—	—	—	—
80,000	2.0	2.2	2.6	2.7	2.9	3.4	4.2	5.1	5.8	6.7	8.0	9.4	12.2	15.4	19.4	24.3	30.7	49.0	77.3	—	—	—	—	—	—
70,000	1.8	1.9	2.3	2.4	2.5	3.0	3.7	4.5	5.1	5.9	7.0	8.1	10.3	13.1	16.5	19.2	23.0	36.7	58.0	—	—	—	—	—	—
60,000	1.6	1.7	2.0	2.1	2.2	2.6	3.1	3.8	4.3	5.0	6.0	7.1	9.0	11.5	14.5	17.3	21.0	32.7	50.0	—	—	—	—	—	—
50,000	1.3	1.4	1.6	1.7	1.8	2.1	2.6	3.2	3.6	4.2	5.0	5.9	7.6	9.6	12.1	15.2	19.2	30.6	46.3	—	—	—	—	—	—
40,000	1.0	1.1	1.3	1.4	1.4	1.7	2.1	2.6	2.9	3.4	4.0	4.7	6.1	7.7	9.7	12.2	15.3	24.4	36.6	—	—	—	—	—	—
30,000	0.7	0.8	0.9	1.0	1.1	1.3	1.6	1.9	2.2	2.5	3.0	3.6	4.6	5.8	7.3	9.1	11.5	18.3	29.0	—	—	—	—	—	—
20,000	0.5	0.5	0.6	0.7	0.7	0.9	1.1	1.3	1.5	1.7	2.0	2.4	3.0	3.8	4.8	5.9	7.4	11.9	18.3	—	—	—	—	—	—
10,000	0.3	0.3	0.3	0.3	0.4	0.4	0.5	0.6	0.7	0.8	1.0	1.2	1.5	1.9	2.4	3.0	3.8	6.1	9.7	—	—	—	—	—	—
9,000	0.2	0.3	0.3	0.3	0.3	0.4	0.5	0.6	0.7	0.8	0.9	1.1	1.4	1.7	2.2	2.7	3.5	5.6	8.7	—	—	—	—	—	—
8,000	0.2	0.2	0.3	0.3	0.3	0.3	0.4	0.5	0.6	0.7	0.8	0.9	1.2	1.5	1.9	2.4	3.1	4.9	7.7	—	—	—	—	—	—
7,000	0.1	0.2	0.2	0.2	0.2	0.3	0.3	0.4	0.5	0.5	0.6	0.7	1.0	1.3	1.7	2.1	2.7	4.3	6.8	—	—	—	—	—	—
6,000	0.1	0.2	0.2	0.2	0.2	0.2	0.3	0.4	0.4	0.5	0.6	0.7	1.0	1.2	1.5	1.8	2.3	3.7	5.8	—	—	—	—	—	—
5,000	0.1	0.1	0.2	0.2	0.2	0.2	0.3	0.4	0.4	0.5	0.6	0.7	1.0	1.2	1.5	1.9	2.3	3.1	4.8	—	—	—	—	—	—
4,000	0.1	0.1	0.1	0.1	0.1	0.2	0.2	0.3	0.3	0.4	0.5	0.6	0.8	0.9	1.2	1.5	2.4	3.9	6.0	—	—	—	—	—	—
3,000	0.1	0.1	0.1	0.1	0.1	0.2	0.2	0.2	0.2	0.3	0.4	0.5	0.6	0.7	0.9	1.2	1.8	2.9	4.5	—	—	—	—	—	—
2,000	0.1	0.1	0.1	0.1	0.1	0.1	0.1	0.2	0.2	0.2	0.2	0.2	0.3	0.4	0.5	0.8	1.2	1.9	3.0	—	—	—	—	—	—
1,000	—	—	—	—	—	—	—	—	—	—	—	—	—	—	—	—	—	—	—	—	—	—	—	—	—
900	—	—	—	—	—	—	—	—	—	—	—	—	—	—	—	—	—	—	—	—	—	—	—	—	—
800	—	—	—	—	—	—	—	—	—	—	—	—	—	—	—	—	—	—	—	—	—	—	—	—	—
700	—	—	—	—	—	—	—	—	—	—	—	—	—	—	—	—	—	—	—	—	—	—	—	—	—
600	—	—	—	—	—	—	—	—	—	—	—	—	—	—	—	—	—	—	—	—	—	—	—	—	—
500	—	—	—	—	—	—	—	—	—	—	—	—	—	—	—	—	—	—	—	—	—	—	—	—	—
400	—	—	—	—	—	—	—	—	—	—	—	—	—	—	—	—	—	—	—	—	—	—	—	—	—
300	—	—	—	—	—	—	—	—	—	—	—	—	—	—	—	—	—	—	—	—	—	—	—	—	—
200	—	—	—	—	—	—	—	—	—	—	—	—	—	—	—	—	—	—	—	—	—	—	—	—	—
100	—	—	—	—	—	—	—	—	—	—	—	—	—	—	—	—	—	—	—	—	—	—	—	—	—

* Solid Conductors. Other conductors are stranded.

Note 1—The footage employed in the tabulated ampere feet refers to the length of run of the circuit rather than to the footage of individual conductor.

Note 2—The above table is figured at 60°C since this is an estimate of the average temperature which may be anticipated in service. The table may be used without significant error for conductor temperatures up to and including 75°C.

TABLE 3.63 Volts Drop for CU Conductor in Magnetic Conduit—70 Percent PF

WIRE SIZE AWG or MCM	1000	900	800	750	700	600	500	400	350	300	250	4/0	3/0	2/0	1/0	1	2	4	6	8*	10*	12*	14*
	Volts Drop																						
Ampere Feet																							
500,000	41.0	42.0	44.0	45.0	46.0	48.0	51.0	56.0	60.0	64.0	71.0	77.0	89.0	104.0	122.0	144.0	173.0	254.0	380.0	—	—	—	—
400,000	32.8	33.6	35.2	36.0	36.8	38.4	40.8	44.8	48.0	51.2	56.8	61.6	71.2	84.2	97.6	115.0	138.0	203.0	304.0	456.0	—	—	—
300,000	24.6	25.2	26.4	27.0	27.6	28.8	30.6	33.6	36.0	38.4	42.6	46.2	53.4	62.4	73.2	86.4	103.0	152.0	228.0	342.0	—	—	—
200,000	16.4	16.8	17.6	18.0	18.4	19.2	20.4	22.4	24.0	25.6	28.4	30.8	35.6	41.6	48.8	57.6	69.2	101.0	152.0	228.0	354.0	—	—
100,000	8.2	8.4	8.8	9.0	9.2	9.6	10.2	11.2	12.0	12.8	14.2	15.4	17.8	20.8	24.4	28.8	34.6	50.8	76.0	114.0	177.0	278.0	438.0
90,000	7.4	7.5	7.9	8.1	8.3	8.6	9.2	10.1	10.8	11.5	12.7	13.8	16.0	18.7	21.9	25.9	31.1	45.7	68.4	103.0	159.0	250.0	392.0
80,000	6.6	6.7	7.0	7.2	7.4	7.7	8.2	8.9	9.6	10.2	11.4	12.3	14.2	16.6	19.5	23.0	27.7	40.6	60.8	91.2	142.0	222.0	349.0
70,000	6.7	5.9	6.2	6.3	6.4	6.7	7.1	7.8	8.4	8.9	9.9	10.8	12.5	14.5	17.1	20.2	24.2	35.5	53.2	79.7	124.0	194.0	306.0
60,000	4.9	5.0	5.3	5.4	5.5	5.8	6.1	6.7	7.2	7.7	8.5	9.2	10.7	12.5	14.6	17.3	20.8	30.5	45.6	68.3	106.0	167.0	262.0
50,000	4.1	4.2	4.4	4.5	4.6	4.8	5.1	5.6	6.0	6.4	7.1	7.7	8.9	10.4	12.2	14.4	17.3	25.4	38.0	56.9	88.5	139.0	218.0
40,000	3.3	3.4	3.5	3.6	3.7	3.8	4.1	4.5	4.8	5.1	5.7	6.2	7.1	8.4	9.8	11.5	13.8	20.3	30.4	45.6	70.8	111.0	174.0
30,000	2.5	2.5	2.6	2.7	2.8	2.9	3.1	3.4	3.6	3.8	4.3	4.6	5.3	6.2	7.3	8.6	10.3	15.2	22.8	34.2	53.1	83.4	131.0
20,000	1.6	1.7	1.8	1.8	1.8	1.9	2.0	2.2	2.4	2.6	2.9	3.1	3.6	4.2	4.9	5.8	6.9	10.1	15.2	22.8	35.4	55.6	87.2
10,000	0.8	0.8	0.9	0.9	0.9	1.0	1.0	1.1	1.2	1.3	1.4	1.5	1.8	2.1	2.4	2.9	3.5	5.1	7.6	11.4	17.7	27.8	43.6
9,000	0.7	0.8	0.8	0.8	0.8	0.9	0.9	1.0	1.1	1.2	1.3	1.4	1.6	1.9	2.2	2.6	3.1	4.6	6.8	10.3	15.9	25.0	39.2
8,000	0.7	0.7	0.7	0.7	0.7	0.8	0.8	0.9	1.0	1.0	1.1	1.2	1.4	1.7	2.0	2.3	2.8	4.1	6.1	9.1	14.2	22.2	34.9
7,000	0.6	0.6	0.6	0.6	0.6	0.7	0.7	0.8	0.8	0.9	1.0	1.1	1.3	1.5	1.7	2.0	2.4	3.6	5.3	7.8	12.4	19.4	30.6
6,000	0.5	0.5	0.5	0.5	0.6	0.6	0.6	0.7	0.7	0.8	0.9	0.9	1.1	1.3	1.5	1.7	2.1	3.1	4.6	6.8	10.6	16.7	26.2
5,000	0.4	0.4	0.4	0.5	0.5	0.5	0.5	0.6	0.6	0.6	0.7	0.8	0.9	1.0	1.2	1.4	1.7	2.5	3.8	5.7	8.9	13.9	21.8
4,000	0.3	0.3	0.4	0.4	0.4	0.4	0.4	0.5	0.5	0.5	0.6	0.6	0.7	0.8	1.0	1.2	1.4	2.0	3.0	4.6	7.1	11.1	17.4
3,000	0.3	0.3	0.3	0.3	0.3	0.3	0.3	0.3	0.4	0.4	0.4	0.4	0.5	0.6	0.7	0.9	1.0	1.5	2.3	3.4	5.3	8.3	13.1
2,000	0.2	0.2	0.2	0.2	0.2	0.2	0.2	0.2	0.2	0.3	0.3	0.4	0.4	0.5	0.6	0.7	1.0	1.5	2.3	3.5	5.6	8.7	14.0
1,000	0.1	0.1	0.1	0.1	0.1	0.1	0.1	0.1	0.1	0.1	0.1	0.1	0.1	0.2	0.2	0.3	0.4	0.6	0.8	1.1	1.8	2.8	4.4
900	0.1	0.1	0.1	0.1	0.1	0.1	0.1	0.1	0.1	0.1	0.1	0.1	0.2	0.2	0.2	0.3	0.3	0.5	0.7	1.0	1.5	2.5	3.9
800	0.1	0.1	0.1	0.1	0.1	0.1	0.1	0.1	0.1	0.1	0.1	0.1	0.1	0.1	0.2	0.2	0.2	0.3	0.4	0.6	0.9	1.4	2.2
700	0.1	0.1	0.1	0.1	0.1	0.1	0.1	0.1	0.1	0.1	0.1	0.1	0.1	0.1	0.2	0.2	0.2	0.2	0.3	0.4	0.6	1.2	1.9
600	0.1	0.1	0.1	0.1	0.1	0.1	0.1	0.1	0.1	0.1	0.1	0.1	0.1	0.1	0.2	0.2	0.2	0.2	0.3	0.6	0.7	1.1	1.7
500	—	—	—	0.1	0.1	0.1	0.1	0.1	0.1	0.1	0.1	0.1	0.1	0.1	0.1	0.1	0.1	0.2	0.3	0.4	0.6	0.9	1.4
400	—	—	—	—	—	—	—	—	—	—	—	—	—	—	—	—	—	—	—	—	—	—	—
300	—	—	—	—	—	—	—	—	—	—	—	—	—	—	—	—	—	—	—	—	—	—	—
200	—	—	—	—	—	—	—	—	—	—	—	—	—	—	—	—	—	—	—	—	—	—	—
100	—	—	—	—	—	—	—	—	—	—	—	—	—	—	—	—	—	—	—	—	—	—	—

* Solid Conductors. Other conductors are stranded.

Note 1—The above table gives voltage drops encountered in a single phase two-wire system. The voltage drops in other systems may be obtained through multiplication by appropriate factors listed below:

System for Which Voltage Drop is Desired	Multiplying Factor for Modification of Values in Table
Single Phase—3 Wire—Line to Line	1.00
Single Phase—3 Wire—Line to Neutral	0.50
Three Phase—3 Wire—Line to Line	0.866
Three Phase—4 Wire—Line to Line	0.666
Three Phase—4 Wire—Line to Neutral	0.50

Note 3—The footage employed in the tabulated ampere feet refers to the length of run of the circuit rather than to the footage of individual conductor.

Note 4—The above table is figured at 60°C since this is an estimate of the average temperature which may be anticipated in service. The table may be used without significant error for conductor temperatures up to and including 75°C.

Note 2—Allowable voltage drops for systems other than single phase, two-wire cannot be used directly in the above table. Such drops should be modified through multiplication by the appropriate factor listed below. The voltage thus modified may then be used to obtain the proper wire size directly from the table.

System for Which Allowable Voltage Drop is Known	Multiplying Factor for Modification of Known Value to Permit Direct Use of Table
Single Phase—3 Wire—Line to Line	1.00
Single Phase—3 Wire—Line to Neutral	2.00
Three Phase—3 Wire—Line to Line	1.155
Three Phase—4 Wire—Line to Line	1.155
Three Phase—4 Wire—Line to Neutral	2.00

TABLE 3.64 Volts Drop for CU Conductor in Magnetic Conduit—80 Percent PF

WIRE SIZE AWG or MCM	1000	900	800	750	700	600	500	400	350	300	250	4/0	3/0	2/0	1/0	1	2	4	6	8*	10*	12*	14*
	Volts Drop																						
Amperes Feet																							
500,000	38.0	39.0	41.0	42.0	43.0	46.0	49.0	55.0	58.0	64.0	71.0	78.0	92.0	108.0	130.0	153.0	186.0	278.0	421.0	—	—	—	—
400,000	30.4	31.2	32.8	33.6	34.4	36.8	39.2	44.0	46.4	51.2	56.8	62.4	73.6	86.4	104.0	122.0	148.0	222.0	336.0	—	—	—	—
300,000	22.8	23.4	24.6	25.2	25.8	27.6	29.4	33.0	34.8	38.4	42.6	46.8	55.2	64.8	78.0	91.8	111.0	166.0	252.0	381.0	—	—	—
200,000	15.2	15.6	16.4	16.8	17.2	18.4	19.6	22.0	23.2	25.6	28.4	31.2	36.8	43.2	52.0	61.2	74.0	111.0	168.0	254.0	398.0	—	—
100,000	7.6	7.8	8.2	8.4	8.6	9.2	9.8	11.0	11.6	12.8	14.2	15.6	18.4	21.6	26.0	30.6	37.2	56.6	84.2	127.0	199.0	314.0	494.0
90,000	6.9	7.0	7.4	7.6	7.7	8.3	8.8	9.9	10.4	11.5	12.8	14.0	16.6	19.4	23.4	27.5	33.5	50.0	75.8	115.0	179.0	283.0	445.0
80,000	6.1	6.2	6.6	6.7	6.9	7.4	7.8	8.8	9.3	10.2	11.4	12.5	14.7	17.3	20.8	24.5	29.8	44.5	67.4	102.0	160.0	252.0	395.0
70,000	5.3	5.5	5.7	5.9	6.0	6.4	6.9	7.7	8.1	8.9	9.9	10.9	12.9	15.1	18.2	21.4	26.0	38.9	58.9	89.3	140.0	220.0	346.0
60,000	4.6	4.7	4.9	5.0	5.2	5.5	5.9	6.6	6.9	7.7	8.5	9.4	11.0	12.9	15.6	18.4	22.3	33.4	50.5	76.6	120.0	188.0	296.0
50,000	3.8	3.9	4.1	4.2	4.3	4.6	4.9	5.5	5.8	6.4	7.1	7.8	9.2	10.8	13.0	15.3	18.6	27.8	42.1	63.7	99.7	157.0	247.0
40,000	3.0	3.1	3.3	3.4	3.4	3.7	3.9	4.4	4.6	5.1	5.7	6.2	7.4	8.6	10.4	12.2	14.8	22.2	33.6	50.3	79.6	126.0	199.0
30,000	2.3	2.3	2.5	2.5	2.6	2.8	2.9	3.3	3.5	3.8	4.3	4.7	5.5	6.5	7.8	9.2	11.1	16.5	25.2	38.1	59.7	94.2	149.0
20,000	1.5	1.6	1.6	1.7	1.7	1.8	2.0	2.2	2.3	2.6	2.8	3.1	3.7	4.3	5.2	6.1	7.4	11.1	16.8	25.4	38.5	62.8	99.8
10,000	0.8	0.8	0.8	0.8	0.9	0.9	1.0	1.1	1.2	1.3	1.4	1.6	1.8	2.2	2.6	3.1	3.7	5.8	8.4	12.7	19.9	31.4	49.4
9,000	0.7	0.7	0.7	0.8	0.8	0.8	0.9	1.0	1.0	1.2	1.3	1.4	1.7	1.9	2.3	2.8	3.4	5.0	7.6	11.6	17.9	28.3	44.5
8,000	0.6	0.6	0.7	0.7	0.7	0.7	0.8	0.9	0.9	1.0	1.1	1.3	1.5	1.7	2.1	2.5	3.0	4.5	6.7	10.2	16.0	25.2	39.5
7,000	0.5	0.6	0.6	0.6	0.6	0.6	0.7	0.8	0.8	0.9	1.0	1.1	1.3	1.5	1.8	2.1	2.6	3.9	5.9	8.9	14.0	22.0	34.5
6,000	0.5	0.5	0.5	0.5	0.5	0.6	0.6	0.7	0.7	0.8	0.9	0.9	1.1	1.3	1.6	1.8	2.2	3.3	5.1	7.7	12.0	18.8	29.6
5,000	0.4	0.4	0.4	0.4	0.4	0.5	0.5	0.6	0.6	0.6	0.7	0.8	0.9	1.1	1.3	1.5	1.9	2.8	4.2	6.4	10.0	15.7	24.7
4,000	0.3	0.3	0.3	0.3	0.3	0.4	0.4	0.4	0.5	0.5	0.6	0.6	0.7	0.9	1.0	1.2	1.5	2.2	3.4	5.1	8.0	12.6	19.9
3,000	0.2	0.2	0.3	0.3	0.3	0.3	0.3	0.3	0.4	0.4	0.4	0.5	0.6	0.7	0.8	0.9	1.1	1.7	2.5	3.8	6.0	9.4	14.9
2,000	0.2	0.2	0.2	0.2	0.2	0.2	0.2	0.2	0.2	0.3	0.3	0.3	0.4	0.4	0.5	0.6	0.7	1.1	1.7	2.5	4.0	6.3	10.0
1,000	0.1	0.1	0.1	0.1	0.1	0.1	0.1	0.1	0.1	0.1	0.1	0.1	0.2	0.2	0.3	0.4	0.6	0.8	1.3	2.0	3.1	4.9	7.9
900	0.1	0.1	0.1	0.1	0.1	0.1	0.1	0.1	0.1	0.1	0.1	0.1	0.2	0.2	0.2	0.3	0.3	0.5	0.8	1.2	1.8	2.8	4.5
800	0.1	0.1	0.1	0.1	0.1	0.1	0.1	0.1	0.1	0.1	0.1	0.1	0.2	0.2	0.2	0.3	0.3	0.5	0.7	1.0	1.6	2.5	3.9
700	0.1	0.1	0.1	0.1	0.1	0.1	0.1	0.1	0.1	0.1	0.1	0.1	0.2	0.2	0.2	0.3	0.4	0.6	0.9	1.4	2.2	3.5	5.5
600	0.1	0.1	0.1	0.1	0.1	0.1	0.1	0.1	0.1	0.1	0.1	0.1	0.1	0.1	0.1	0.2	0.2	0.3	0.5	0.8	1.2	1.9	2.9
500	—	—	—	—	—	0.1	0.1	0.1	0.1	0.1	0.1	0.1	0.1	0.1	0.1	0.2	0.2	0.3	0.4	0.6	1.0	1.6	2.5
400	—	—	—	—	—	—	—	—	—	0.1	0.1	0.1	0.1	0.1	0.1	0.1	0.2	0.2	0.3	0.5	0.8	1.3	2.0
300	—	—	—	—	—	—	—	—	—	—	—	—	—	—	0.1	0.1	0.1	0.2	0.3	0.4	0.6	0.9	1.5
200	—	—	—	—	—	—	—	—	—	—	—	—	—	—	—	0.1	0.1	0.1	0.2	0.3	0.4	0.6	1.0
100	—	—	—	—	—	—	—	—	—	—	—	—	—	—	—	—	—	0.1	0.1	0.1	0.2	0.3	0.5

* Solid Conductors. Other conductors are stranded.

Note 1—The above table gives voltage drops encountered in a single phase two-wire system. The voltage drops in other systems may be obtained through multiplication by appropriate factors listed below:

System for Which Voltage Drop is Desired	Multiplying Factor for Modification of Values in Table
Single Phase—3 Wire—Line to Line	1.00
Single Phase—3 Wire—Line to Neutral	0.50
Three Phase—3 Wire—Line to Line	0.866
Three Phase—4 Wire—Line to Line	0.866
Three Phase—4 Wire—Line to Neutral	0.50

Note 3—The footage employed in the tabulated ampere feet refers to the length of run of the circuit rather than to the footage of individual conductor.

Note 4—The above table is figured at 60°C since this is an estimate of the average temperature which may be anticipated in service. The table may be used without significant error for conductor temperatures up to and including 75°C.

Note 2 Allowable voltage drops for systems other than single phase, two-wire cannot be used directly in the above table. Such drops should be modified through multiplication by the appropriate factor listed below. The voltage thus modified may then be used to obtain the proper wire size directly from the table.

System for Which Allowable Voltage Drop is Known	Multiplying Factor for Modification of Known Value to Permit Direct Use of Table
Single Phase—3 Wire—Line to Line	1.00
Single Phase—3 Wire—Line to Neutral	2.00
Three Phase—3 Wire—Line to Line	1.155
Three Phase—4 Wire—Line to Line	1.155
Three Phase—4 Wire—Line to Neutral	2.00

TABLE 3.65 Volts Drop for CU Conductor in Magnetic Conduit—90 Percent PF

WIRE SIZE AWG or MCM	1000	900	800	750	700	600	500	400	350	300	250	4/0	3/0	2/0	1/0	1	2	4	6	8*	10*	12*	14*	
Amps Feet	Volts Drop																							
500,000	33.0	34.0	36.0	37.0	38.0	41.0	45.0	51.0	55.0	61.0	68.0	76.0	84.0	91.0	110.0	123.0	151.0	198.0	300.0	451.0	—	—	—	—
400,000	26.4	26.2	28.8	29.5	30.4	32.8	36.0	40.8	44.0	48.8	54.4	60.8	72.8	88.0	106.0	129.0	158.0	240.0	369.0	—	—	—	—	
300,000	19.8	20.4	21.6	22.2	22.8	24.6	27.0	30.6	33.0	36.6	40.8	45.6	54.6	66.0	79.8	96.6	119.0	180.0	277.0	420.0	—	—	—	
200,000	13.2	13.6	14.4	14.8	15.2	16.4	18.0	20.4	22.0	24.4	27.2	30.4	36.4	44.0	53.2	64.4	79.2	120.0	184.0	280.0	442.0	—	—	
100,000	6.6	6.8	7.2	7.4	7.6	8.2	9.0	10.2	11.0	12.2	13.6	15.2	18.2	22.0	26.6	32.2	39.6	60.0	92.2	140.0	221.0	351.0	—	
90,000	5.9	6.2	6.4	6.8	6.5	7.4	8.1	9.2	9.9	10.9	12.3	13.6	16.3	19.8	23.8	28.9	35.8	54.0	82.9	126.0	199.0	316.0	498.0	
80,000	5.2	5.5	5.7	6.0	6.1	6.6	7.2	8.2	8.8	9.7	10.9	12.1	14.5	17.6	21.2	25.7	31.8	48.0	73.7	112.0	177.0	281.0	443.0	
70,000	4.6	4.8	5.0	5.2	5.3	5.7	6.3	7.1	7.7	8.5	9.5	10.6	12.7	15.4	18.6	22.5	27.8	42.0	64.5	98.4	155.0	246.0	388.0	
60,000	4.0	4.1	4.3	4.4	4.6	4.9	5.4	6.1	6.6	7.3	8.1	9.1	10.9	13.2	16.0	19.3	23.6	36.0	55.3	84.3	133.0	210.0	332.0	
50,000	3.3	3.4	3.6	3.7	3.8	4.1	4.5	5.1	5.5	6.1	6.8	7.6	9.1	11.0	13.3	16.1	19.8	30.0	46.1	70.2	111.0	176.0	277.0	
40,000	2.6	2.6	2.8	2.9	3.0	3.3	3.6	4.1	4.4	4.9	5.4	6.1	7.3	8.8	10.6	12.9	15.8	24.0	36.9	56.0	88.4	140.0	222.0	
30,000	1.9	2.0	2.1	2.2	2.3	2.5	2.7	3.1	3.3	3.7	4.1	4.6	5.5	6.6	7.9	9.7	11.9	18.0	27.7	42.0	66.3	105.0	166.0	
20,000	1.3	1.4	1.4	1.5	1.5	1.6	1.8	2.0	2.2	2.4	2.7	3.0	3.6	4.4	5.3	6.4	7.9	12.0	18.4	28.0	44.2	70.2	111.0	
10,000	0.7	0.7	0.7	0.7	0.7	0.8	1.0	1.0	1.1	1.2	1.4	1.5	1.8	2.2	2.7	3.2	3.9	6.0	9.2	14.0	22.1	35.1	55.4	
9,000	0.6	0.6	0.6	0.7	0.7	0.7	0.8	0.9	1.0	1.1	1.2	1.4	1.6	1.9	2.4	2.9	3.6	5.4	8.3	12.6	19.9	31.6	49.8	
8,000	0.5	0.6	0.6	0.6	0.6	0.7	0.7	0.8	0.9	1.0	1.1	1.2	1.5	1.8	2.1	2.6	3.2	4.8	7.4	11.2	17.7	28.1	44.3	
7,000	0.4	0.5	0.5	0.5	0.5	0.6	0.7	0.8	0.9	1.1	1.3	1.5	1.9	2.3	2.8	3.4	5.0	7.6	11.5	17.8	28.1	44.3	69.8	
6,000	0.4	0.4	0.4	0.4	0.5	0.5	0.5	0.6	0.7	0.7	0.8	0.9	1.1	1.3	1.6	1.9	2.4	3.6	5.5	8.4	13.3	21.0	33.2	
5,000	0.3	0.3	0.4	0.4	0.4	0.4	0.5	0.6	0.6	0.6	0.7	0.8	0.9	1.1	1.3	1.6	1.9	3.0	4.6	7.0	11.1	17.6	27.7	
4,000	0.3	0.3	0.3	0.3	0.3	0.3	0.4	0.4	0.4	0.5	0.5	0.6	0.7	0.9	1.1	1.3	1.6	2.4	3.7	5.6	8.8	14.0	22.2	
3,000	0.2	0.2	0.2	0.2	0.2	0.2	0.3	0.3	0.3	0.4	0.4	0.5	0.6	0.7	0.8	1.0	1.2	1.8	2.8	4.2	6.6	10.5	16.6	
2,000	0.1	0.1	0.1	0.2	0.2	0.2	0.2	0.2	0.2	0.2	0.3	0.3	0.4	0.4	0.5	0.6	0.8	1.2	1.8	2.8	4.4	7.0	11.1	
1,000	0.1	0.1	0.1	0.1	0.1	0.1	0.1	0.1	0.1	0.1	0.1	0.2	0.2	0.2	0.3	0.3	0.4	0.6	0.9	1.4	2.2	3.5	5.5	
900	—	0.1	0.1	0.1	0.1	0.1	0.1	0.1	0.1	0.1	0.1	0.1	0.1	0.2	0.2	0.3	0.4	0.5	0.8	1.3	2.0	3.2	5.0	
800	—	0.1	0.1	0.1	0.1	0.1	0.1	0.1	0.1	0.1	0.1	0.1	0.1	0.2	0.2	0.2	0.3	0.5	0.7	1.1	1.8	2.8	4.4	
700	—	—	0.1	0.1	0.1	0.1	0.1	0.1	0.1	0.1	0.1	0.1	0.1	0.2	0.2	0.2	0.3	0.4	0.7	1.0	1.6	2.5	3.9	
600	—	—	—	—	—	—	0.1	0.1	0.1	0.1	0.1	0.1	0.1	0.2	0.2	0.2	0.2	0.4	0.6	0.8	1.3	2.1	3.3	
500	—	—	—	—	—	—	—	0.1	0.1	0.1	0.1	0.1	0.1	0.1	0.1	0.2	0.2	0.3	0.5	0.7	1.1	1.8	2.8	
400	—	—	—	—	—	—	—	—	—	—	—	—	—	—	—	0.1	0.1	0.2	0.4	0.6	0.9	1.4	2.2	
300	—	—	—	—	—	—	—	—	—	—	—	—	—	—	—	—	0.1	0.2	0.3	0.4	0.7	1.1	1.7	
200	—	—	—	—	—	—	—	—	—	—	—	—	—	—	—	—	—	0.1	0.2	0.3	0.4	0.7	1.1	
100	—	—	—	—	—	—	—	—	—	—	—	—	—	—	—	—	—	—	0.1	0.2	0.3	0.4	0.6	

* Solid Conductors. Other conductors are stranded.

Note 1—The above table gives voltage drops encountered in a single phase two-wire system. The voltage drops in other systems may be obtained through multiplication by appropriate factors listed below:

System for Which Voltage Drop Is Desired	Multiplying Factors for Modification of Values in Table
Single Phase—3 Wire—Line to Line	1.00
Single Phase—3 Wire—Line to Neutral	0.50
Three Phase—3 Wire—Line to Line	0.866
Three Phase—4 Wire—Line to Line	0.866
Three Phase—4 Wire—Line to Neutral	0.50

Note 2—The footage employed in the tabulated ampere feet refers to the length of run of the circuit rather than to the footage of individual conductor.

Note 4—The above table is figured at 60°C since this is an estimate of the average temperature which may be anticipated in service. The table may be used without significant error for conductor temperatures up to and including 75°C.

Note 2—Allowable voltage drops for systems other than single phase, two-wire cannot be used directly in the above table. Such drops should be modified through multiplication by the appropriate factor listed below. The voltage thus modified may then be used to obtain the proper wire size directly from the table.

System for Which Allowable Voltage Drop is Known	Multiplying Factor for Modification of Known Value to Permit Direct Use of Table
Single Phase—3 Wire—Line to Line	1.00
Single Phase—3 Wire—Line to Neutral	2.00
Three Phase—3 Wire—Line to Line	1.155
Three Phase—4 Wire—Line to Line	1.155
Three Phase—4 Wire—Line to Neutral	2.00

TABLE 3.66 Volts Drop for CU Conductor in Magnetic Conduit—95 Percent PF

WIRE SIZE AWG or MCM	1000	900	800	750	700	600	500	400	350	300	250	4/0	3/0	2/0	1/0	1	2	4	6	8*	10*	12*	14*
	Volts Drop																						
Amperes Feet																							
500,000	29.0	30.0	32.0	33.0	34.0	37.0	41.0	47.0	51.0	58.0	65.0	74.0	89.0	109.0	133.0	161.0	200.0	308.0	478.0	—	—	—	—
400,000	23.2	24.0	25.6	26.4	28.2	29.6	32.8	37.5	40.8	46.4	52.0	59.2	71.2	87.2	106.0	129.0	160.0	245.0	380.0	—	—	—	—
300,000	17.4	18.0	19.2	19.8	20.4	22.2	24.6	28.2	30.6	34.8	39.0	44.4	53.4	65.4	79.8	96.6	120.0	184.0	285.0	438.0	—	—	—
200,000	11.6	12.0	12.8	13.2	13.6	14.8	16.4	18.8	20.4	23.2	26.0	29.6	35.6	43.6	53.2	64.4	80.0	123.0	190.0	292.0	464.0	—	—
100,000	5.8	6.0	6.4	6.6	6.8	7.4	8.2	9.4	10.2	11.6	13.0	14.8	17.8	21.8	26.6	32.2	40.0	61.6	95.2	146.0	232.0	389.0	—
90,000	5.3	5.4	5.8	5.9	6.2	6.8	7.3	8.6	9.1	10.5	11.7	13.4	16.1	19.7	23.8	28.9	36.0	55.6	85.4	132.0	209.0	332.0	—
80,000	4.7	4.8	5.2	5.2	5.5	6.0	6.5	7.6	8.1	9.3	10.4	11.9	14.3	17.5	21.2	25.7	32.0	49.4	76.0	117.0	185.0	295.0	466.0
70,000	4.1	4.2	4.5	4.6	4.8	5.2	5.7	6.6	7.1	8.1	9.1	10.4	12.5	15.3	18.6	22.5	28.0	43.2	66.6	103.0	162.0	258.0	408.0
60,000	3.5	3.6	3.8	4.0	4.1	4.4	4.9	5.6	6.1	6.9	7.8	8.9	10.7	13.1	16.0	19.3	24.0	37.0	57.2	89.0	139.0	221.0	349.0
50,000	2.9	3.0	3.2	3.3	3.4	3.7	4.1	4.7	5.1	5.8	6.5	7.4	8.9	10.9	13.3	16.1	20.0	30.8	47.6	73.2	116.0	184.0	291.0
40,000	2.3	2.4	2.5	2.6	2.6	2.9	3.3	3.8	4.1	4.6	5.2	5.9	7.1	8.7	10.6	12.9	16.0	24.5	38.0	58.4	92.8	148.0	233.0
30,000	1.7	1.8	1.9	2.0	2.0	2.2	2.6	2.8	3.1	3.5	3.9	4.4	5.3	6.5	7.9	9.7	12.0	18.4	28.5	43.8	69.6	111.0	175.0
20,000	1.2	1.2	1.3	1.3	1.4	1.5	1.6	1.9	2.0	2.3	2.6	2.9	3.6	4.4	5.3	6.4	8.0	12.3	19.0	29.2	46.4	73.8	116.0
10,000	0.6	0.6	0.6	0.7	0.7	0.7	0.8	0.9	1.0	1.2	1.3	1.5	1.8	2.2	2.7	3.2	4.0	6.2	9.5	14.6	23.2	36.9	58.2
9,000	0.6	0.5	0.6	0.6	0.6	0.7	0.7	0.9	0.9	1.1	1.2	1.3	1.6	1.9	2.4	2.9	3.6	5.6	8.5	13.2	20.9	33.2	52.4
8,000	0.5	0.5	0.5	0.5	0.5	0.6	0.6	0.8	0.8	0.9	1.0	1.2	1.4	1.8	2.1	2.6	3.2	4.9	7.5	11.7	18.5	29.5	46.6
7,000	0.4	0.4	0.5	0.5	0.5	0.5	0.6	0.7	0.7	0.8	0.9	1.0	1.3	1.5	1.9	2.3	2.8	4.3	6.7	10.3	16.2	25.8	40.8
6,000	0.4	0.4	0.4	0.4	0.4	0.4	0.5	0.6	0.6	0.7	0.8	0.9	1.1	1.3	1.6	1.9	2.4	3.7	5.7	8.8	13.9	22.1	34.9
5,000	0.3	0.3	0.3	0.3	0.3	0.4	0.4	0.5	0.5	0.6	0.7	0.7	0.9	1.1	1.3	1.6	2.0	3.1	4.8	7.3	11.6	18.4	29.1
4,000	0.2	0.2	0.3	0.3	0.3	0.3	0.4	0.4	0.5	0.5	0.6	0.7	0.9	1.1	1.3	1.6	2.5	3.8	5.8	9.3	14.8	23.1	36.1
3,000	0.1	0.2	0.2	0.2	0.2	0.2	0.3	0.3	0.4	0.4	0.4	0.4	0.5	0.7	0.8	1.0	1.2	1.8	2.9	4.4	7.0	11.1	17.5
2,000	0.1	0.1	0.1	0.1	0.1	0.2	0.2	0.2	0.2	0.3	0.3	0.4	0.4	0.5	0.6	0.8	1.2	1.9	2.9	4.6	7.4	11.6	18.4
1,000	0.1	0.1	0.1	0.1	0.1	0.1	0.1	0.1	0.1	0.1	0.1	0.2	0.2	0.2	0.3	0.3	0.4	0.6	1.0	1.5	2.3	3.7	5.8
900	0.1	0.1	0.1	0.1	0.1	0.1	0.1	0.1	0.1	0.1	0.1	0.1	0.2	0.2	0.2	0.3	0.4	0.6	0.9	1.3	2.1	3.3	5.2
800	0.1	0.1	0.1	0.1	0.1	0.1	0.1	0.1	0.1	0.1	0.1	0.1	0.1	0.2	0.2	0.3	0.3	0.5	0.8	1.2	1.9	2.9	4.7
700	—	—	—	—	—	0.1	0.1	0.1	0.1	0.1	0.1	0.1	0.1	0.2	0.2	0.2	0.3	0.4	0.7	1.0	1.6	2.6	4.1
600	—	—	—	—	—	—	—	0.1	0.1	0.1	0.1	0.1	0.1	0.1	0.2	0.2	0.2	0.4	0.6	0.9	1.4	2.2	3.5
500	—	—	—	—	—	—	—	—	0.1	0.1	0.1	0.1	0.1	0.1	0.1	0.1	0.2	0.3	0.5	0.7	1.2	1.8	2.9
400	—	—	—	—	—	—	—	—	—	0.1	0.1	0.1	0.1	0.1	0.1	0.1	0.2	0.3	0.4	0.6	0.9	1.5	2.3
300	—	—	—	—	—	—	—	—	—	—	0.1	0.1	0.1	0.1	0.1	0.1	0.2	0.3	0.4	0.7	1.1	1.7	2.8
200	—	—	—	—	—	—	—	—	—	—	—	—	—	—	0.1	0.1	0.1	0.1	0.2	0.3	0.5	0.7	1.2
100	—	—	—	—	—	—	—	—	—	—	—	—	—	—	—	—	0.1	0.1	0.2	0.2	0.4	0.6	0.9

* Solid Conductors. Other conductors are stranded.

Note 1—The above table gives voltage drops encountered in a single phase two-wire system. The voltage drops in other systems may be obtained through multiplication by appropriate factors listed below:

System for Which Voltage Drop is Desired	Multiplying Factors for Modification of Values in Table
Single Phase—3 Wire—Line to Line	1.00
Single Phase—3 Wire—Line to Neutral	0.50
Three Phase—3 Wire—Line to Line	0.866
Three Phase—4 Wire—Line to Line	0.866
Three Phase—4 Wire—Line to Neutral	0.50

Note 3—The footage employed in the tabulated amperes feet refers to the length of run of the circuit rather than to the footage of individual conductor.

Note 4—The above table is figured at 60°C since this is an estimate of the average temperature which may be anticipated in service. The table may be used without significant error for conductor temperatures up to and including 75°C.

Note 2—Allowable voltage drops for systems other than single phase, two-wire cannot be used directly in the above table. Such drops should be modified through multiplication by the appropriate factor listed below. The voltage thus modified may then be used to obtain the proper wire size directly from the table.

System for Which Allowable Voltage Drop is Known	Multiplying Factor for Modification of Known Value to Permit Direct Use of Table
Single Phase—3 Wire—Line to Line	1.00
Single Phase—3 Wire—Line to Neutral	2.00
Three Phase—3 Wire—Line to Line	1.155
Three Phase—4 Wire—Line to Line	1.155
Three Phase—4 Wire—Line to Neutral	2.00

TABLE 3.67 Volts Drop for CU Conductor in Magnetic Conduit—100 Percent PF

WIRE SIZE AWG or MCM	1000	900	800	750	700	600	500	400	350	300	250	4/0	3/0	2/0	1/0	1	2	4	6	8*	10*	12*	14*	
	Volts Drop																							
Amperes Feet																								
500,000	16.4	17.9	19.6	20.3	21.5	24.4	28.8	34.8	39.0	45.0	53.4	62.4	78.6	98.5	123.0	153.0	194.0	306.0	483.0	—	—	—	—	
400,000	13.1	14.3	15.7	16.2	17.2	19.5	23.0	27.8	31.2	36.0	42.8	50.0	62.9	78.8	98.4	122.0	155.0	244.0	386.0	—	—	—	—	
300,000	9.9	10.7	11.8	12.2	12.9	14.6	17.3	20.9	23.4	27.0	32.0	37.4	47.2	59.1	73.9	91.8	116.0	184.0	290.0	450.0	—	—	—	
200,000	6.6	7.2	7.8	8.1	8.6	9.8	11.6	14.0	15.6	18.0	21.4	25.0	31.4	39.4	49.2	61.2	77.6	122.0	193.0	300.0	480.0	—	—	
100,000	3.3	3.6	3.9	4.1	4.3	4.9	5.8	7.0	7.8	9.0	10.7	12.5	15.7	19.7	24.6	30.6	38.8	61.2	96.6	150.0	240.0	384.0	—	
90,000	2.9	3.2	3.5	3.7	3.9	4.4	5.2	6.3	7.0	8.1	9.6	11.2	14.2	17.7	22.2	27.5	34.9	55.1	87.0	135.0	216.0	345.0	—	
80,000	2.6	2.9	3.1	3.2	3.4	3.9	4.6	5.6	6.2	7.2	8.5	10.0	12.6	15.8	19.7	24.5	31.0	49.0	77.3	120.0	192.0	307.0	487.0	
70,000	2.3	2.5	2.7	2.8	3.0	3.4	4.0	4.9	5.4	6.3	7.5	8.7	11.0	13.8	17.2	21.4	27.2	42.8	67.6	105.0	169.0	269.0	426.0	
60,000	2.0	2.1	2.3	2.4	2.6	2.9	3.4	4.2	4.7	5.4	6.4	7.5	9.4	11.8	14.8	18.4	23.3	36.7	58.0	90.0	144.0	230.0	365.0	
50,000	1.6	1.8	1.9	2.0	2.2	2.4	2.9	3.5	3.9	4.5	5.3	6.2	7.9	9.9	12.3	15.3	19.4	30.6	48.3	74.9	120.0	192.0	304.0	
40,000	1.3	1.4	1.6	1.7	1.9	2.3	2.8	3.1	3.6	4.3	5.0	6.0	7.3	9.8	12.2	15.5	24.4	38.6	60.0	96.0	154.0	243.0		
30,000	1.0	1.1	1.2	1.2	1.3	1.5	1.7	2.1	2.3	2.7	3.2	3.7	4.7	5.9	7.4	9.2	11.6	18.4	29.0	45.0	72.0	115.0	182.0	
20,000	0.7	0.7	0.8	0.8	0.9	1.0	1.2	1.4	1.6	1.8	2.1	2.5	3.1	3.9	4.9	5.1	7.8	12.2	19.3	30.3	48.0	78.9	122.0	
10,000	0.3	0.4	0.4	0.4	0.4	0.5	0.6	0.7	0.8	0.9	1.1	1.3	1.6	1.9	2.5	3.1	3.9	6.1	9.7	15.0	24.0	38.4	60.8	
9,000	0.3	0.3	0.4	0.4	0.4	0.4	0.5	0.6	0.7	0.8	1.0	1.1	1.4	1.8	2.2	2.8	3.5	5.5	8.7	13.5	21.6	34.5	54.7	
8,000	0.3	0.3	0.3	0.3	0.3	0.4	0.5	0.6	0.6	0.7	0.9	1.0	1.3	1.6	1.9	2.5	3.1	4.9	7.7	12.0	19.2	30.7	48.7	
7,000	0.2	0.3	0.3	0.3	0.3	0.3	0.4	0.5	0.5	0.6	0.8	0.9	1.1	1.4	1.7	2.1	2.7	4.3	6.8	10.5	16.8	26.9	42.6	
6,000	0.2	0.2	0.2	0.2	0.3	0.3	0.3	0.4	0.5	0.5	0.6	0.8	0.9	1.2	1.5	1.8	2.3	3.7	5.8	9.0	14.4	23.0	36.5	
5,000	0.2	0.2	0.2	0.2	0.2	0.2	0.3	0.4	0.4	0.5	0.5	0.6	0.8	1.0	1.2	1.5	1.9	3.1	4.8	7.5	12.0	19.2	30.4	
4,000	0.1	0.1	0.2	0.2	0.2	0.2	0.2	0.3	0.3	0.4	0.4	0.5	0.6	0.8	1.0	1.2	1.5	2.4	3.8	6.0	9.5	15.4	24.3	
3,000	0.1	0.1	0.1	0.1	0.1	0.2	0.2	0.2	0.2	0.3	0.4	0.4	0.5	0.6	0.7	0.9	1.2	1.8	2.9	4.5	7.2	11.5	18.2	
2,000	0.1	0.1	0.1	0.1	0.1	0.1	0.1	0.1	0.2	0.2	0.2	0.3	0.3	0.4	0.5	0.6	0.8	1.2	1.9	3.0	4.8	7.7	12.2	
1,000	—	—	—	—	—	0.1	0.1	0.1	0.1	0.1	0.1	0.1	0.2	0.2	0.3	0.4	0.6	1.0	1.5	2.4	3.9	6.1	9.7	
900	—	—	—	—	—	—	0.1	0.1	0.1	0.1	0.1	0.1	0.1	0.1	0.2	0.3	0.4	0.6	0.9	1.4	2.2	3.5	5.5	
800	—	—	—	—	—	—	0.1	0.1	0.1	0.1	0.1	0.1	0.1	0.1	0.2	0.2	0.3	0.3	0.5	0.8	1.2	1.9	3.1	4.9
700	—	—	—	—	—	—	—	0.1	0.1	0.1	0.1	0.1	0.1	0.1	0.2	0.2	0.3	0.4	0.7	1.1	1.7	2.7	4.3	
600	—	—	—	—	—	—	—	—	0.1	0.1	0.1	0.1	0.1	0.1	0.1	0.2	0.2	0.2	0.4	0.6	0.9	1.4	2.3	3.7
500	—	—	—	—	—	—	—	—	—	0.1	0.1	0.1	0.1	0.1	0.1	0.2	0.2	0.3	0.5	0.8	1.2	1.9	3.0	
400	—	—	—	—	—	—	—	—	—	—	—	—	0.1	0.1	0.1	0.1	0.2	0.2	0.4	0.6	1.0	1.5	2.4	
300	—	—	—	—	—	—	—	—	—	—	—	—	—	0.1	0.1	0.1	0.1	0.2	0.3	0.5	0.7	1.2	1.8	
200	—	—	—	—	—	—	—	—	—	—	—	—	—	—	0.1	0.1	0.1	0.1	0.2	0.3	0.5	0.8	1.2	
100	—	—	—	—	—	—	—	—	—	—	—	—	—	—	—	—	0.1	0.1	0.2	0.2	0.4	0.4	0.6	

* Solid Conductors. Other conductors are stranded.

Note 1—The above table gives voltage drops encountered in a single phase two-wire system. The voltage drops in other systems may be obtained through multiplication by appropriate factors listed below:

System for Which Voltage Drop is Desired	Multiplying Factors for Modification of Values in Table
Single Phase—3 Wire—Line to Line	1.00
Single Phase—3 Wire—Line to Neutral	0.50
Three Phase—3 Wire—Line to Line	0.866
Three Phase—4 Wire—Line to Line	0.866
Three Phase—4 Wire—Line to Neutral	0.50

Note 3—The footage employed in the tabulated amperes feet refers to the length of run of the circuit rather than to the footage of individual conductor.

Note 4—The above table is figured at 60°C since this is an estimate of the average temperature which may be anticipated in service. The table may be used without significant error for conductor temperatures up to and including 75°C.

Note 2—Allowable voltage drops for systems other than single phase, two-wire cannot be used directly in the above table. Such drops should be modified through multiplication by the appropriate factor listed below. The voltage thus modified may then be used to obtain the proper wire size directly from the table.

System for Which Allowable Voltage Drop is Known	Multiplying Factor for Modification of Known Value to Permit Direct Use of Table
Single Phase—3 Wire—Line to Line	1.00
Single Phase—3 Wire—Line to Neutral	2.00
Three Phase—3 Wire—Line to Line	1.155
Three Phase—4 Wire—Line to Line	1.155
Three Phase—4 Wire—Line to Neutral	2.00

TABLE 3.68 Volts Drop for CU Conductor in Nonmagnetic Conduit—70 Percent PF

WIRE SIZE AWG or MCM	1000	900	800	750	700	600	500	400	350	300	250	4/0	3/0	2/0	1/0	1	2	4	6	8*	10*	12*	14*
	Volts Drop																						
Amperes Feet																							
500,000	33.0	34.0	36.0	37.0	38.0	40.0	43.0	48.0	51.0	6.0	62.0	88.0	81.0	95.0	114.0	136.0	164.0	246.0	372.0	—	—	—	—
400,000	26.4	27.2	28.8	29.6	30.4	32.0	34.4	38.4	40.8	44.8	49.6	54.4	64.8	76.0	91.2	109.0	131.0	196.0	297.0	448.0	—	—	—
300,000	19.8	20.4	21.6	22.2	22.8	24.0	25.8	28.8	30.6	33.6	37.2	40.8	48.6	57.0	68.4	81.6	98.4	147.0	223.0	336.0	—	—	—
200,000	13.2	13.6	14.4	14.8	15.2	16.0	17.2	19.2	20.4	22.4	24.8	27.2	32.4	38.0	45.6	54.4	65.6	98.0	148.0	224.0	—	—	—
100,000	6.6	6.8	7.2	7.4	7.6	8.0	8.6	9.6	10.2	11.2	12.4	13.6	16.2	19.0	22.8	27.2	32.8	49.2	74.4	112.0	350.0	276.0	434.0
90,000	5.9	6.2	6.4	6.7	6.8	7.2	7.7	8.6	9.2	10.1	11.3	12.3	14.6	17.1	20.5	24.5	29.6	44.2	67.1	101.0	158.0	248.0	390.0
80,000	5.2	5.5	5.7	6.0	6.1	6.4	6.9	7.7	8.2	8.9	10.0	10.9	13.0	15.2	18.3	21.8	26.2	39.3	59.6	89.6	140.0	221.0	347.0
70,000	4.6	4.8	5.0	5.2	5.3	5.6	6.0	6.7	7.1	7.8	8.7	9.5	11.3	13.3	16.0	19.0	23.0	34.4	52.1	78.4	123.0	193.0	304.0
60,000	4.0	4.1	4.3	4.4	4.6	4.8	5.2	5.8	6.1	6.7	7.4	8.1	9.7	11.4	13.7	16.3	19.7	29.5	44.6	67.3	105.0	166.0	260.0
50,000	3.3	3.4	3.6	3.7	3.8	4.0	4.3	4.8	5.1	5.6	6.2	6.8	8.1	9.6	11.4	13.6	16.4	24.6	37.2	56.0	87.6	138.0	217.0
40,000	2.6	2.6	2.9	2.9	3.0	3.2	3.4	3.8	4.1	4.5	4.9	5.4	6.6	7.6	9.1	10.9	13.1	19.6	29.7	44.8	70.0	110.0	174.0
30,000	1.9	2.0	2.1	2.2	2.3	2.4	2.6	2.9	3.1	3.4	3.7	4.1	4.8	5.7	6.8	8.2	9.8	14.7	22.3	33.6	52.5	82.8	130.0
20,000	1.3	1.3	1.4	1.5	1.5	1.6	1.7	1.9	2.0	2.2	2.5	2.7	3.2	3.8	4.5	5.4	6.6	9.8	14.8	22.4	35.0	55.2	86.8
10,000	0.7	0.7	0.7	0.7	0.8	0.8	0.9	1.0	1.0	1.1	1.2	1.4	1.6	1.9	2.3	2.7	3.3	4.9	7.4	11.2	17.5	27.6	43.4
5,000	0.6	0.6	0.6	0.7	0.7	0.8	0.8	0.9	0.9	1.0	1.1	1.2	1.5	1.7	2.1	2.5	2.9	4.4	6.7	10.1	15.8	24.5	39.0
5,000	0.5	0.6	0.6	0.6	0.6	0.6	0.7	0.8	0.8	0.9	1.0	1.1	1.3	1.5	1.8	2.2	2.6	3.9	5.9	8.9	14.0	22.1	34.7
7,000	0.5	0.5	0.5	0.5	0.5	0.6	0.6	0.7	0.7	0.8	0.9	1.0	1.1	1.3	1.6	1.9	2.3	3.4	5.2	7.8	12.3	19.3	30.4
8,000	0.4	0.4	0.4	0.4	0.5	0.5	0.5	0.6	0.6	0.7	0.7	0.8	1.0	1.1	1.4	1.6	1.9	2.9	4.5	6.7	10.6	16.6	26.0
5,000	0.3	0.3	0.4	0.4	0.4	0.4	0.4	0.5	0.5	0.6	0.6	0.7	0.8	1.0	1.1	1.4	1.6	2.5	3.7	5.6	8.8	13.8	21.7
4,000	0.3	0.3	0.3	0.3	0.3	0.3	0.3	0.4	0.4	0.5	0.5	0.5	0.7	0.8	0.9	1.1	1.3	1.9	2.9	4.5	7.0	11.0	17.4
3,000	0.2	0.2	0.2	0.2	0.2	0.2	0.3	0.3	0.3	0.3	0.4	0.4	0.5	0.6	0.7	0.8	1.0	1.5	2.2	3.4	5.3	8.3	13.0
2,000	0.1	0.1	0.1	0.2	0.2	0.2	0.2	0.2	0.2	0.2	0.3	0.3	0.3	0.4	0.5	0.6	0.7	1.0	1.6	2.2	3.5	5.5	8.7
1,000	0.1	0.1	0.1	0.1	0.1	0.1	0.1	0.1	0.1	0.1	0.1	0.1	0.2	0.2	0.3	0.3	0.3	0.5	0.7	1.1	1.8	2.8	4.3
900	0.1	0.1	0.1	0.1	0.1	0.1	0.1	0.1	0.1	0.1	0.1	0.1	0.2	0.2	0.2	0.3	0.3	0.4	0.7	1.0	1.6	2.5	3.9
800	0.1	0.1	0.1	0.1	0.1	0.1	0.1	0.1	0.1	0.1	0.1	0.1	0.1	0.2	0.2	0.2	0.3	0.4	0.6	0.9	1.4	2.2	3.6
700	0.1	0.1	0.1	0.1	0.1	0.1	0.1	0.1	0.1	0.1	0.1	0.1	0.1	0.1	0.2	0.2	0.3	0.5	0.8	1.2	1.9	3.0	
600	—	—	—	—	0.1	0.1	0.1	0.1	0.1	0.1	0.1	0.1	0.1	0.1	0.1	0.2	0.2	0.3	0.5	0.7	1.1	1.7	2.6
500	—	—	—	—	—	—	—	0.1	0.1	0.1	0.1	0.1	0.1	0.1	0.1	0.1	0.2	0.3	0.4	0.6	0.9	1.4	2.2
400	—	—	—	—	—	—	—	—	—	0.1	0.1	0.1	0.1	0.1	0.1	0.1	0.1	0.2	0.3	0.5	0.7	1.1	1.7
300	—	—	—	—	—	—	—	—	—	—	—	—	—	0.1	0.1	0.1	0.1	0.1	0.2	0.3	0.5	0.8	1.3
200	—	—	—	—	—	—	—	—	—	—	—	—	—	—	—	0.1	0.1	0.1	0.1	0.2	0.4	0.6	0.9
100	—	—	—	—	—	—	—	—	—	—	—	—	—	—	—	—	—	0.1	0.1	0.1	0.2	0.3	0.4

* Solid Conductors. Other conductors are stranded.

Note 1—The above table gives voltage drops encountered in a single phase two-wire system. The voltage drops in other systems may be obtained through multiplication by appropriate factors listed below:

System for Which Voltage Drop is Desired	Multiplying Factors for Modification of Values in Table
Single Phase—3 Wire—Line to Line	1.00
Single Phase—3 Wire—Line to Neutral	0.50
Three Phase—3 Wire—Line to Line	0.866
Three Phase—4 Wire—Line to Line	0.866
Three Phase—4 Wire—Line to Neutral	0.50

Note 3—The footage employed in the tabulated amperes feet refers to the length of run of the circuit rather than to the footage of individual conductor.

Note 4—The above table is figured at 60°C since this is an estimate of the average temperature which may be anticipated in service. The table may be used without significant error for conductor temperatures up to and including 76°C.

Note 2—Allowable voltage drops for systems other than single phase, two wire cannot be used directly in the above table. Such drops should be modified through multiplication by the appropriate factor listed below. The voltage thus modified may then be used to obtain the proper wire size directly from the table.

System for Which Allowable Voltage Drop is Known	Multiplying Factor for Modification of Known Value to Permit Direct Use of Table
Single Phase—3 Wire—Line to Line	1.00
Single Phase—3 Wire—Line to Neutral	2.00
Three Phase—3 Wire—Line to Line	1.155
Three Phase—4 Wire—Line to Line	1.155
Three Phase—4 Wire—Line to Neutral	2.00

TABLE 3.69 Volts Drop for CU Conductor in Nonmagnetic Conduit—80 Percent PF

WIRE SIZE AWG or MCM	1000	900	800	750	700	600	500	400	350	300	250	4/0	3/0	2/0	1/0	1	2	4	6	8*	10*	12*	14*
Amperes Feet	V o l t s D r o p																						
500,000	31.0	32.0	33.0	34.0	36.0	38.0	42.0	47.0	51.0	56.0	63.0	70.0	83.0	100.0	121.0	147.0	179.0	217.0	414.0	—	—	—	—
400,000	24.8	26.6	28.4	26.2	28.8	30.4	33.6	37.6	40.8	44.8	50.4	56.0	66.4	80.0	96.8	118.0	143.0	212.0	329.0	—	—	—	—
300,000	18.6	19.2	19.8	20.4	21.6	22.8	25.2	28.2	30.6	33.6	37.8	42.0	49.8	60.0	72.6	88.2	107.0	163.0	247.0	378.0	—	—	—
200,000	12.4	12.8	13.2	13.6	14.4	15.2	16.8	18.8	20.4	22.4	25.2	28.0	33.2	40.0	48.4	58.8	71.6	109.0	165.0	252.0	396.0	—	—
100,000	6.2	6.4	6.6	6.8	7.2	7.6	8.4	9.4	10.2	11.2	12.6	14.0	16.6	20.0	24.2	29.4	35.8	54.4	82.8	126.0	198.0	313.0	492.0
90,000	5.5	5.8	5.9	6.2	6.4	6.5	7.6	8.6	9.1	10.1	11.3	12.6	14.9	18.0	21.8	26.6	32.2	49.1	74.6	113.0	178.0	282.0	443.0
80,000	4.9	5.2	5.2	5.5	5.7	6.1	6.7	7.6	8.1	8.9	10.1	11.2	13.3	16.0	19.4	23.6	28.6	43.6	66.3	101.0	168.0	260.0	394.0
70,000	4.3	4.5	4.6	4.8	5.0	5.3	5.9	6.6	7.1	7.8	8.8	9.8	11.6	14.0	17.0	20.6	25.0	38.1	58.0	88.2	139.0	219.0	345.0
60,000	3.7	3.8	4.0	4.1	4.3	4.6	5.0	5.6	6.1	6.7	7.5	8.4	10.0	12.0	14.5	17.6	21.5	32.6	49.7	75.6	119.0	188.0	295.0
50,000	3.1	3.2	3.3	3.4	3.6	3.8	4.2	4.7	5.1	5.6	6.3	7.0	8.3	10.0	12.1	14.7	17.9	27.2	41.4	62.9	99.0	157.0	246.0
40,000	2.5	2.6	2.6	2.6	2.9	3.0	3.4	3.7	4.1	4.5	5.0	5.6	6.6	8.0	9.7	11.8	14.3	21.7	32.9	50.4	79.2	125.0	197.0
30,000	1.9	1.9	1.9	2.0	2.2	2.3	2.5	2.8	3.1	3.4	3.8	4.2	4.9	6.0	7.3	8.8	10.7	16.3	24.7	37.8	59.4	93.9	148.0
20,000	1.2	1.3	1.3	1.4	1.4	1.5	1.7	1.9	2.0	2.2	2.5	2.8	3.3	4.0	4.8	5.9	7.2	10.9	16.6	25.2	39.6	62.6	98.4
10,000	0.6	0.6	0.7	0.7	0.7	0.8	0.8	0.9	1.0	1.1	1.3	1.4	1.7	2.0	2.4	2.9	3.6	5.4	8.3	12.6	19.8	31.3	49.2
9,000	0.6	0.6	0.6	0.6	0.6	0.7	0.8	0.9	0.9	1.0	1.1	1.3	1.5	1.8	2.2	2.7	3.2	4.9	7.5	11.3	17.8	28.2	44.3
8,000	0.5	0.5	0.5	0.6	0.6	0.6	0.7	0.8	0.8	0.9	1.0	1.1	1.3	1.6	1.9	2.4	2.9	4.4	6.8	10.1	15.8	25.0	39.4
7,000	0.4	0.5	0.5	0.5	0.5	0.5	0.6	0.7	0.7	0.8	0.9	1.0	1.2	1.4	1.7	2.1	2.6	3.8	5.8	8.8	13.9	21.9	34.5
6,000	0.4	0.4	0.4	0.4	0.4	0.5	0.5	0.6	0.6	0.7	0.8	0.8	1.0	1.2	1.5	1.8	2.2	3.3	4.9	7.6	11.9	18.8	29.5
5,000	0.3	0.3	0.3	0.3	0.4	0.4	0.4	0.5	0.5	0.6	0.6	0.7	0.8	1.0	1.2	1.5	1.8	2.7	4.1	6.3	9.9	15.7	24.6
4,000	0.3	0.3	0.3	0.3	0.3	0.3	0.3	0.4	0.4	0.5	0.5	0.6	0.6	0.7	0.8	1.0	1.2	1.4	2.2	3.3	5.0	7.9	12.5
3,000	0.2	0.2	0.2	0.2	0.2	0.2	0.3	0.3	0.3	0.3	0.4	0.4	0.5	0.6	0.7	0.9	1.1	1.6	2.6	3.8	5.9	9.4	14.8
2,000	0.1	0.1	0.1	0.1	0.1	0.2	0.2	0.2	0.2	0.2	0.3	0.3	0.3	0.4	0.5	0.6	0.7	1.1	1.7	2.5	3.9	6.3	9.8
1,000	0.1	0.1	0.1	0.1	0.1	0.1	0.1	0.1	0.1	0.1	0.1	0.1	0.1	0.2	0.2	0.3	0.4	0.6	0.8	1.3	1.9	3.1	4.9
900	0.1	0.1	0.1	0.1	0.1	0.1	0.1	0.1	0.1	0.1	0.1	0.1	0.1	0.2	0.2	0.2	0.3	0.3	0.5	0.8	1.1	1.8	2.8
800	0.1	0.1	0.1	0.1	0.1	0.1	0.1	0.1	0.1	0.1	0.1	0.1	0.1	0.1	0.2	0.2	0.2	0.3	0.4	0.7	1.0	1.6	2.5
700	—	0.1	0.1	0.1	0.1	0.1	0.1	0.1	0.1	0.1	0.1	0.1	0.1	0.1	0.1	0.2	0.2	0.3	0.4	0.6	0.9	1.4	2.2
600	—	—	—	—	—	0.1	0.1	0.1	0.1	0.1	0.1	0.1	0.1	0.1	0.1	0.2	0.2	0.2	0.3	0.5	0.8	1.2	1.9
500	—	—	—	—	—	—	—	0.1	0.1	0.1	0.1	0.1	0.1	0.1	0.1	0.2	0.2	0.3	0.4	0.6	1.0	1.6	
400	—	—	—	—	—	—	—	—	—	—	—	—	—	—	—	—	—	—	—	—	—	—	
300	—	—	—	—	—	—	—	—	—	—	—	—	—	—	—	—	—	—	—	—	—	—	
200	—	—	—	—	—	—	—	—	—	—	—	—	—	—	—	—	—	—	—	—	—	—	
100	—	—	—	—	—	—	—	—	—	—	—	—	—	—	—	—	—	—	—	—	—	—	

* Solid Conductors. Other conductors are stranded.

Note 1.—The above table gives voltage drops encountered in a single phase two-wire system. The voltage drops in other systems may be obtained through multiplication by appropriate factors listed below:

System for Which Voltage Drop is Desired	Multiplying Factors for Modification of Values in Table
Single Phase—3 Wire—Line to Line	1.00
Single Phase—3 Wire—Line to Neutral	0.50
Three Phase—3 Wire—Line to Line	0.866
Three Phase—4 Wire—Line to Line	0.866
Three Phase—4 Wire—Line to Neutral	0.50

Note 3.—The footage employed in the tabulated ampere feet refers to the length of run of the circuit rather than to the footage of individual conductor.

Note 4.—The above table is figured at 60°C since this is an estimate of the average temperature which may be anticipated in service. The table may be used without significant error for conductor temperatures up to and including 75°C.

Note 2.—Allowable voltage drops for systems other than single phase, two wire cannot be used directly in the above table. Such drops should be modified through multiplication by the appropriate factor listed below. The voltage thus modified may then be used to obtain the proper wire size directly from the table.

System for Which Allowable Voltage Drop is Known	Multiplying Factor for Modification of Known Value to Permit Direct Use of Table
Single Phase—3 Wire—Line to Line	1.00
Single Phase—3 Wire—Line to Neutral	2.00
Three Phase—3 Wire—Line to Line	1.155
Three Phase—4 Wire—Line to Line	1.155
Three Phase—4 Wire—Line to Neutral	2.00



TABLE 3.70 Volts Drop for CU Conductor in Nonmagnetic Conduit—90 Percent PF

WIRE SIZE AWG or MCM	1000	900	800	750	700	600	500	400	350	300	250	4/0	3/0	2/0	1/0	1	2	4	6	8*	10*	12*	14*
Amperes Feet	V o l t s D r o p																						
500,000	27.0	28.0	30.0	31.0	32.0	34.0	39.0	44.0	49.0	55.0	62.0	69.0	85.0	103.0	127.0	155.0	191.0	295.0	456.0	—	—	—	—
400,000	21.6	22.4	24.0	24.8	25.5	26.2	31.2	35.2	39.2	44.0	49.6	55.2	68.0	82.4	102.0	124.0	153.0	236.0	364.0	—	—	—	—
300,000	16.2	16.8	18.0	18.6	19.2	20.4	23.4	26.4	29.4	33.0	37.2	41.4	51.0	61.8	76.2	93.0	115.0	177.0	273.0	417.0	—	—	—
200,000	10.8	11.2	12.0	12.4	12.8	13.6	15.6	17.6	19.6	22.0	24.8	27.6	34.0	41.2	50.8	62.0	76.4	118.0	182.0	278.0	440.0	—	—
100,000	5.4	5.6	6.0	6.2	6.4	6.8	7.8	8.8	9.8	11.0	12.4	13.8	17.0	20.6	25.4	31.0	38.2	59.0	91.2	139.0	220.0	350.0	—
90,000	4.8	4.9	5.4	5.5	5.8	6.2	7.0	7.9	8.8	9.9	11.3	12.4	15.3	18.5	22.9	27.9	34.4	53.2	81.7	125.0	198.0	315.0	497.0
80,000	4.3	4.4	4.8	4.9	5.2	5.5	6.2	7.0	7.8	8.8	10.0	11.0	13.6	16.5	20.3	24.8	30.6	47.4	72.7	111.0	176.0	280.0	442.0
70,000	3.8	3.9	4.2	4.3	4.5	4.8	5.5	6.2	6.9	7.7	8.7	9.6	11.9	14.4	17.8	21.7	26.8	41.4	63.7	97.3	154.0	245.0	386.0
60,000	3.2	3.4	3.6	3.7	3.8	4.1	4.7	5.3	5.9	6.6	7.4	8.3	10.2	12.4	15.2	18.6	22.9	35.4	54.7	83.5	132.0	210.0	331.0
50,000	2.7	2.8	3.0	3.1	3.2	3.4	3.9	4.4	4.9	5.5	6.2	6.9	8.5	10.3	12.7	15.5	19.1	29.5	45.6	69.6	110.0	175.0	276.0
40,000	2.2	2.2	2.4	2.5	2.6	2.6	3.1	3.5	3.9	4.4	4.9	5.5	6.8	8.2	10.2	12.4	15.3	23.6	36.4	55.6	88.0	140.0	221.0
30,000	1.6	1.7	1.8	1.8	1.9	2.0	2.3	2.6	2.9	3.3	3.7	4.1	5.1	6.2	7.6	9.3	11.5	17.7	27.3	41.7	66.0	105.0	166.0
20,000	1.1	1.1	1.2	1.2	1.3	1.4	1.6	1.8	1.9	2.2	2.5	2.8	3.4	4.1	5.1	6.2	7.6	11.8	18.2	27.8	44.0	70.0	110.0
10,000	0.5	0.6	0.6	0.6	0.6	0.7	0.8	0.9	1.0	1.1	1.2	1.4	1.7	2.1	2.6	3.1	3.8	5.9	9.1	13.9	22.0	35.0	55.2
9,000	0.5	0.5	0.5	0.6	0.6	0.6	0.7	0.8	0.9	1.0	1.1	1.2	1.5	1.9	2.3	2.8	3.4	5.3	8.2	12.5	19.8	31.5	49.7
8,000	0.4	0.4	0.5	0.5	0.5	0.6	0.6	0.7	0.8	0.9	1.0	1.1	1.4	1.7	2.0	2.5	3.1	4.7	7.3	11.1	17.6	28.0	44.2
7,000	0.4	0.4	0.4	0.4	0.5	0.5	0.6	0.6	0.7	0.8	0.9	1.0	1.2	1.4	1.8	2.2	2.7	4.1	6.4	9.7	15.4	24.5	38.6
6,000	0.3	0.3	0.4	0.4	0.4	0.4	0.5	0.5	0.6	0.7	0.7	0.8	1.0	1.2	1.5	1.9	2.3	3.5	5.5	8.4	13.2	21.0	33.1
5,000	0.3	0.3	0.3	0.3	0.3	0.3	0.4	0.4	0.5	0.6	0.6	0.7	0.9	1.0	1.3	1.6	1.9	2.9	4.6	6.9	11.0	17.5	27.6
4,000	0.2	0.2	0.2	0.3	0.3	0.3	0.3	0.4	0.4	0.4	0.5	0.6	0.7	0.8	1.0	1.2	1.5	2.4	3.6	5.6	8.8	14.0	22.1
3,000	0.2	0.2	0.2	0.2	0.2	0.2	0.2	0.3	0.3	0.3	0.4	0.4	0.5	0.6	0.8	0.9	1.2	1.9	2.7	4.2	6.6	10.5	16.6
2,000	0.1	0.1	0.1	0.1	0.1	0.1	0.2	0.2	0.2	0.2	0.3	0.3	0.3	0.4	0.5	0.6	0.9	1.2	1.8	2.8	4.4	7.0	11.0
1,000	0.1	0.1	0.1	0.1	0.1	0.1	0.1	0.1	0.1	0.1	0.1	0.1	0.2	0.2	0.3	0.3	0.4	0.6	0.9	1.4	2.2	3.5	5.5
900	0.1	0.1	0.1	0.1	0.1	0.1	0.1	0.1	0.1	0.1	0.1	0.1	0.2	0.2	0.2	0.3	0.3	0.5	0.8	1.3	1.9	3.2	4.9
800	—	—	0.1	0.1	0.1	0.1	0.1	0.1	0.1	0.1	0.1	0.1	0.1	0.2	0.2	0.3	0.3	0.5	0.7	1.1	1.8	2.9	4.4
700	—	—	—	—	0.1	0.1	0.1	0.1	0.1	0.1	0.1	0.1	0.1	0.1	0.2	0.2	0.3	0.4	0.6	1.0	1.5	2.5	3.9
600	—	—	—	—	—	0.1	0.1	0.1	0.1	0.1	0.1	0.1	0.1	0.1	0.2	0.2	0.2	0.4	0.6	0.8	1.3	2.1	3.3
500	—	—	—	—	—	—	—	—	0.1	0.1	0.1	0.1	0.1	0.1	0.1	0.2	0.2	0.3	0.5	0.7	1.1	1.8	2.8
400	—	—	—	—	—	—	—	—	—	0.1	0.1	0.1	0.1	0.1	0.1	0.1	0.2	0.4	0.6	0.9	1.4	2.2	3.4
300	—	—	—	—	—	—	—	—	—	—	—	—	0.1	0.1	0.1	0.1	0.2	0.3	0.4	0.7	1.1	1.7	2.7
200	—	—	—	—	—	—	—	—	—	—	—	—	—	—	0.1	0.1	0.1	0.2	0.3	0.4	0.7	1.1	1.7
100	—	—	—	—	—	—	—	—	—	—	—	—	—	—	—	—	0.1	0.1	0.1	0.2	0.4	0.7	1.1

* Solid Conductors. Other conductors are stranded.

Note 1—The above table gives voltage drops encountered in a single phase two-wire system. The voltage drops in other systems may be obtained through multiplication by appropriate factors listed below:

System for Which Voltage Drop is Desired	Multiplying Factors for Modification of Values in Table
Single Phase—3 Wire—Line to Line	1.00
Single Phase—3 Wire—Line to Neutral	0.50
Three Phase—3 Wire—Line to Line	0.866
Three Phase—4 Wire—Line to Line	0.866
Three Phase—4 Wire—Line to Neutral	0.50

Note 3—The footage employed in the tabulated ampere feet refers to the length of run of the circuit rather than to the footage of individual conductor.

Note 4—The above table is figured at 60°C since this is an estimate of the average temperature which may be anticipated in service. The table may be used without significant error for conductor temperatures up to and including 75°C.

Note 2—Allowable voltage drops for systems other than single phase, two wire cannot be used directly in the above table. Such drops should be modified through multiplication by the appropriate factor listed below. The voltage thus modified may then be used to obtain the proper wire size directly from the table.

System for Which Allowable Voltage Drop is Known	Multiplying Factor for Modification of Known Value to Permit Direct Use of Table
Single Phase—3 Wire—Line to Line	1.00
Single Phase—3 Wire—Line to Neutral	2.00
Three Phase—3 Wire—Line to Line	1.155
Three Phase—4 Wire—Line to Line	1.155
Three Phase—4 Wire—Line to Neutral	2.00

TABLE 3.71 Volts Drop for CU Conductor in Nonmagnetic Conduit—95 Percent PF

WIRE SIZE AWG or MCM	1000	900	800	750	700	600	500	400	350	300	250	4/0	3/0	2/0	1/0	1	2	4	6	8*	10*	12*	14*
	Volts Drop																						
Amperes Feet																							
500,000	23.0	25.0	25.0	27.0	29.0	31.0	36.0	41.0	45.0	53.0	60.0	67.0	84.0	103.0	128.0	157.0	195.0	305.0	473.0	—	—	—	—
400,000	18.4	20.0	20.8	21.6	23.2	24.8	28.8	32.8	36.8	42.4	48.0	53.6	67.2	82.4	102.0	126.0	156.0	244.0	378.0	—	—	—	—
300,000	13.8	15.0	15.6	16.2	17.4	18.6	21.6	24.6	27.6	31.8	36.0	40.2	50.4	61.8	76.8	94.2	117.0	183.0	283.0	435.0	—	—	—
200,000	9.2	10.0	10.4	10.8	11.6	12.4	14.4	16.4	18.4	21.2	24.0	26.8	33.6	41.2	51.2	62.8	78.0	122.0	189.0	290.0	462.0	—	—
100,000	4.6	5.0	5.2	5.4	5.8	6.2	7.2	8.2	9.2	10.6	12.0	13.4	16.8	20.6	25.6	31.4	39.0	61.0	94.5	145.0	231.0	368.0	—
90,000	4.1	4.5	4.6	4.8	5.3	5.5	6.4	7.3	8.3	9.4	10.8	12.1	15.1	18.5	23.0	28.2	35.1	54.6	85.2	131.0	208.0	334.0	—
80,000	3.7	4.0	4.1	4.3	4.7	4.9	5.7	6.5	7.4	8.4	9.6	10.7	13.4	16.5	20.5	25.1	31.2	48.6	75.7	116.0	185.0	290.0	466.0
70,000	3.2	3.5	3.6	3.8	4.1	4.3	5.0	5.7	6.4	7.4	8.4	9.4	11.8	14.4	17.9	22.0	27.3	42.6	66.2	102.0	162.0	258.0	408.0
60,000	2.7	3.0	3.1	3.2	3.5	3.7	4.3	4.9	5.5	6.4	7.2	8.0	10.1	12.4	15.4	18.8	23.4	36.6	56.7	87.5	139.0	221.0	350.0
50,000	2.3	2.5	2.6	2.7	2.9	3.1	3.6	4.1	4.6	5.3	6.0	6.7	8.4	10.3	12.8	15.7	19.5	30.5	47.3	72.8	116.0	184.0	291.0
40,000	1.8	2.0	2.1	2.2	2.3	2.5	2.9	3.3	3.7	4.2	4.8	5.4	6.7	8.2	10.2	12.6	15.6	24.4	37.8	58.0	92.4	147.0	232.0
30,000	1.4	1.5	1.5	1.6	1.7	1.9	2.2	2.5	2.8	3.2	3.6	4.0	5.0	6.2	7.7	9.4	11.7	18.3	28.3	43.5	69.3	110.0	174.0
20,000	0.9	1.0	1.0	1.1	1.2	1.4	1.6	1.8	2.1	2.4	2.7	3.4	4.1	5.1	6.3	7.8	12.2	18.9	29.0	46.2	73.5	116.0	—
10,000	0.5	0.5	0.5	0.5	0.6	0.6	0.7	0.8	0.9	1.1	1.2	1.3	1.7	2.1	2.6	3.1	3.9	6.1	9.5	14.5	23.1	36.8	58.1
9,000	0.4	0.5	0.5	0.5	0.5	0.6	0.6	0.7	0.8	0.9	1.1	1.2	1.5	1.9	2.3	2.8	3.5	5.5	8.5	13.1	20.8	33.1	52.4
8,000	0.4	0.4	0.4	0.4	0.5	0.5	0.6	0.7	0.7	0.8	1.0	1.1	1.3	1.7	2.1	2.5	3.1	4.9	7.5	11.5	18.5	29.4	46.5
7,000	0.3	0.4	0.4	0.4	0.4	0.4	0.5	0.6	0.6	0.7	0.8	0.9	1.2	1.4	1.8	2.2	2.7	4.3	6.6	10.2	16.2	25.8	40.8
6,000	0.3	0.3	0.3	0.3	0.4	0.4	0.4	0.5	0.6	0.6	0.7	0.8	1.0	1.2	1.5	1.9	2.3	3.7	5.7	8.8	13.9	22.1	35.0
5,000	0.2	0.3	0.3	0.3	0.3	0.3	0.4	0.4	0.5	0.5	0.6	0.7	0.8	1.0	1.3	1.6	1.9	3.1	4.7	7.3	11.6	18.4	29.1
4,000	0.2	0.2	0.2	0.2	0.2	0.3	0.3	0.3	0.4	0.4	0.5	0.5	0.7	0.9	1.1	1.3	1.6	2.4	3.8	5.8	9.2	14.7	23.2
3,000	0.1	0.2	0.2	0.2	0.2	0.2	0.3	0.3	0.3	0.4	0.4	0.4	0.5	0.6	0.8	0.9	1.2	1.9	2.8	4.4	6.9	11.0	17.4
2,000	0.1	0.1	0.1	0.1	0.1	0.1	0.1	0.2	0.2	0.2	0.2	0.3	0.3	0.4	0.5	0.6	0.8	1.2	1.9	2.9	4.6	7.4	11.6
1,000	0.1	0.1	0.1	0.1	0.1	0.1	0.1	0.1	0.1	0.1	0.1	0.1	0.2	0.2	0.3	0.3	0.4	0.6	1.0	1.5	2.3	3.7	5.8
900	—	0.1	0.1	0.1	0.1	0.1	0.1	0.1	0.1	0.1	0.1	0.1	0.2	0.2	0.2	0.3	0.4	0.6	0.9	1.3	2.1	3.3	5.2
800	—	—	—	—	0.1	0.1	0.1	0.1	0.1	0.1	0.1	0.1	0.1	0.1	0.2	0.3	0.5	0.8	1.2	1.9	2.9	4.7	—
700	—	—	—	—	—	0.1	0.1	0.1	0.1	0.1	0.1	0.1	0.1	0.1	0.2	0.2	0.3	0.4	0.7	1.0	1.6	2.6	4.1
600	—	—	—	—	—	—	0.1	0.1	0.1	0.1	0.1	0.1	0.1	0.1	0.2	0.2	0.2	0.4	0.6	0.9	1.4	2.2	3.5
500	—	—	—	—	—	—	—	0.1	0.1	0.1	0.1	0.1	0.1	0.1	0.1	0.1	0.2	0.3	0.5	0.7	1.2	1.8	2.9
400	—	—	—	—	—	—	—	—	—	—	—	0.1	0.1	0.1	0.1	0.1	0.2	0.2	0.4	0.6	0.9	1.5	2.3
300	—	—	—	—	—	—	—	—	—	—	—	—	0.1	0.1	0.1	0.1	0.1	0.2	0.3	0.4	0.7	1.1	1.7
200	—	—	—	—	—	—	—	—	—	—	—	—	—	—	—	0.1	0.1	0.1	0.2	0.3	0.5	0.7	1.2
100	—	—	—	—	—	—	—	—	—	—	—	—	—	—	—	—	0.1	0.1	0.2	0.2	0.2	0.4	0.6

* Solid Conductors. Other conductors are stranded.

Note 1—The above table gives voltage drops encountered in a single phase two-wire system. The voltage drops in other systems may be obtained through multiplication by appropriate factors listed below:

System for Which Voltage Drop is Desired	Multiplying Factor for Modification of Values in Table
Single Phase—3 Wire—Line to Line	1.00
Single Phase—3 Wire—Line to Neutral	0.50
Three Phase—3 Wire—Line to Line	0.866
Three Phase—4 Wire—Line to Line	0.866
Three Phase—4 Wire—Line to Neutral	0.50

Note 3—The footage employed in the tabulated amperes feet refers to the length of run of the circuit rather than to the footage of individual conductor.

Note 4—The above table is figured at 60°C since this is an estimate of the average temperature which may be anticipated in service. The table may be used without significant error for conductor temperatures up to and including 75°C.

Note 2—Allowable voltage drops for systems other than single phase, two wire cannot be used directly in the above table. Such drops should be modified through multiplication by the appropriate factor listed below. The voltage thus modified may then be used to obtain the proper wire size directly from the table.

System for Which Allowable Voltage Drop is Known	Multiplying Factor for Modification of Known Value to Permit Direct Use of Table
Single Phase—3 Wire—Line to Line	1.00
Single Phase—3 Wire—Line to Neutral	2.00
Three Phase—3 Wire—Line to Line	1.155
Three Phase—4 Wire—Line to Line	1.155
Three Phase—4 Wire—Line to Neutral	2.00

TABLE 3.72 Volts Drop for CU Conductor in Nonmagnetic Conduit—100 Percent PF

WIRE SIZE AWG or MCM	1000	900	800	750	700	600	500	400	350	300	250	4/0	3/0	2/0	1/0	1	2	4	6	8*	10*	12*	14*
Amperes Feet	V o l t s D r o p																						
500,000	13.0	15.0	16.0	17.0	19.0	22.0	26.0	32.0	36.0	42.0	51.0	59.0	75.0	95.0	121.0	152.0	192.0	306.0	483.0	—	—	—	—
400,000	10.4	12.0	12.8	13.6	15.2	17.6	20.8	25.6	28.8	33.6	40.8	47.2	60.0	76.0	96.8	122.0	154.0	244.0	386.0	—	—	—	—
300,000	7.8	9.0	9.6	10.2	11.4	13.2	15.6	19.2	21.6	25.2	30.6	35.4	45.0	57.0	72.6	91.2	115.0	184.0	290.0	450.0	—	—	
200,000	5.2	6.0	6.4	6.8	7.6	8.8	10.4	12.8	14.4	16.8	20.4	23.6	30.0	38.0	48.4	60.8	76.8	122.0	193.0	300.0	480.0	—	
100,000	2.6	3.0	3.2	3.4	3.8	4.4	5.2	6.4	7.2	8.4	10.2	11.8	15.0	19.0	24.2	30.4	38.4	61.2	96.6	150.0	240.0	384.0	
90,000	2.3	2.7	2.9	3.0	3.4	4.0	4.6	5.8	6.4	7.6	9.2	10.6	13.5	17.1	21.8	27.4	34.5	55.1	87.0	135.0	216.0	345.0	
80,000	2.1	2.4	2.5	2.7	3.0	3.5	4.1	5.2	5.7	6.7	8.2	9.4	12.0	15.2	19.4	24.3	30.7	49.0	77.3	120.0	192.0	307.0	
70,000	1.8	2.1	2.2	2.4	2.7	3.1	3.6	4.5	5.0	5.9	7.1	8.3	10.5	13.3	17.0	21.2	26.8	42.8	67.6	105.0	168.0	259.0	
60,000	1.6	1.8	1.9	2.0	2.3	2.6	3.1	3.8	4.3	5.0	6.1	7.1	9.0	11.4	14.5	18.2	23.0	36.7	58.0	90.0	144.0	230.0	
50,000	1.3	1.5	1.6	1.7	1.9	2.2	2.6	3.2	3.6	4.2	5.1	5.9	7.5	9.5	12.1	15.2	19.2	30.6	48.3	74.9	120.0	192.0	
40,000	1.0	1.2	1.3	1.3	1.5	1.7	2.1	2.6	2.9	3.4	4.1	4.7	6.0	7.6	9.7	12.2	15.4	24.4	38.6	60.0	96.0	154.0	
30,000	0.8	0.9	1.0	1.0	1.1	1.3	1.6	1.9	2.2	2.5	3.1	3.6	4.5	5.7	7.3	9.1	11.5	18.4	29.0	45.0	72.0	115.0	
20,000	0.5	0.6	0.6	0.7	0.8	0.9	1.0	1.3	1.4	1.7	2.0	2.4	3.0	3.8	4.8	6.1	7.7	12.2	19.3	30.0	48.0	76.8	
10,000	0.3	0.3	0.3	0.3	0.4	0.4	0.5	0.6	0.7	0.8	1.0	1.2	1.5	1.9	2.4	3.0	3.8	6.1	9.7	15.0	24.0	38.4	
9,000	0.2	0.3	0.3	0.3	0.3	0.4	0.5	0.6	0.6	0.8	0.9	1.1	1.4	1.7	2.2	2.7	3.5	5.5	8.7	13.5	21.6	34.5	
8,000	0.2	0.2	0.3	0.3	0.3	0.4	0.4	0.5	0.6	0.7	0.8	0.9	1.2	1.5	1.9	2.4	3.1	4.9	7.7	12.0	19.2	30.7	
7,000	0.2	0.2	0.2	0.2	0.3	0.3	0.4	0.5	0.5	0.6	0.7	0.8	1.1	1.3	1.7	2.1	2.7	4.3	6.8	10.5	16.8	26.9	
6,000	0.2	0.2	0.2	0.2	0.2	0.3	0.3	0.4	0.4	0.5	0.6	0.7	0.9	1.1	1.5	1.8	2.3	3.7	5.8	9.0	14.4	23.0	
5,000	0.1	0.2	0.2	0.2	0.2	0.2	0.3	0.3	0.4	0.4	0.5	0.6	0.8	1.0	1.2	1.5	1.9	3.1	4.8	7.5	12.0	19.2	
4,000	0.1	0.1	0.1	0.1	0.2	0.2	0.2	0.3	0.3	0.3	0.4	0.5	0.6	0.8	1.0	1.2	1.5	2.4	3.9	6.0	9.5	15.4	
3,000	0.1	0.1	0.1	0.1	0.1	0.1	0.2	0.2	0.2	0.3	0.3	0.4	0.5	0.6	0.7	0.9	1.2	1.8	2.9	4.5	7.2	11.5	
2,000	0.1	0.1	0.1	0.1	0.1	0.1	0.1	0.1	0.1	0.2	0.2	0.2	0.3	0.4	0.5	0.6	0.8	1.2	1.9	3.0	4.8	7.7	
1,000	—	—	—	—	—	—	0.1	0.1	0.1	0.1	0.1	0.1	0.2	0.2	0.3	0.4	0.6	1.0	1.5	2.4	3.8	6.2	
900	—	—	—	—	—	—	0.1	0.1	0.1	0.1	0.1	0.1	0.1	0.1	0.2	0.2	0.3	0.6	0.9	1.4	2.2	3.5	
800	—	—	—	—	—	—	—	0.1	0.1	0.1	0.1	0.1	0.1	0.1	0.2	0.2	0.3	0.5	0.8	1.2	1.9	3.1	
700	—	—	—	—	—	—	—	0.1	0.1	0.1	0.1	0.1	0.1	0.1	0.2	0.2	0.3	0.4	0.7	1.1	1.7	2.7	
600	—	—	—	—	—	—	—	—	0.1	0.1	0.1	0.1	0.1	0.1	0.2	0.2	0.2	0.4	0.6	0.9	1.4	2.3	
500	—	—	—	—	—	—	—	—	—	—	0.1	0.1	0.1	0.1	0.1	0.2	0.2	0.3	0.5	0.8	1.2	1.9	
400	—	—	—	—	—	—	—	—	—	—	—	0.1	0.1	0.1	0.1	0.1	0.2	0.2	0.4	0.6	1.0	1.5	
300	—	—	—	—	—	—	—	—	—	—	—	—	0.1	0.1	0.1	0.1	0.1	0.2	0.3	0.5	0.7	1.2	
200	—	—	—	—	—	—	—	—	—	—	—	—	—	—	0.1	0.1	0.1	0.1	0.2	0.3	0.5	0.8	
100	—	—	—	—	—	—	—	—	—	—	—	—	—	—	—	—	—	0.1	0.1	0.2	0.2	0.4	

* Solid Conductors. Other conductors are stranded.

Note 1—The above table gives voltage drops encountered in a single phase two-wire system. The voltage drops in other systems may be obtained through multiplication by appropriate factors listed below:

System for Which Voltage Drop is Desired	Multiplying Factors for Modification of Values in Table
Single Phase—3 Wire—Line to Line	1.00
Single Phase—3 Wire—Line to Neutral	0.50
Three Phase—3 Wire—Line to Line	0.866
Three Phase—4 Wire—Line to Line	0.866
Three Phase—4 Wire—Line to Neutral	0.50

Note 3—The footage employed in the tabulated ampere feet refers to the length of run of the circuit rather than to the footage of individual conductor.

Note 4—The above table is figured at 60°C since this is an estimate of the average temperature which may be anticipated in service. The table may be used without significant error for conductor temperatures up to and including 75°C.

Note 2—Allowable voltage drops for systems other than single phase, two wire cannot be used directly in the above table. Such drops should be modified through multiplication by the appropriate factor listed below. The voltage thus modified may then be used to obtain the proper wire size directly from the table.

System for Which Allowable Voltage Drop is Known	Multiplying Factor for Modification of Known Value to Permit Direct Use of Table
Single Phase—3 Wire—Line to Line	1.00
Single Phase—3 Wire—Line to Neutral	2.00
Three Phase—3 Wire—Line to Line	1.155
Three Phase—4 Wire—Line to Line	1.155
Three Phase—4 Wire—Line to Neutral	2.00

300



All voltage drops are calculated at 60 Hz and 60°C. This temperature represents a typical conductor temperature encountered in service. No error of practical significance is involved in using the table for any conductor temperature of 75°C or less.

Space limitations make it necessary to prepare the following pages with the “Ampere Feet” column in abbreviated form. For example, reference to the proper table will show that the voltage drop encountered in a 253,000-ampere-foot circuit using 1,000-kcmil aluminum cable would be (for 80 percent power factor, magnetic conduit) $17.6 + 4.4 + 0.3$, or 22.3 V. These voltage drops are the individual drops given by the table for 200,000 ampere feet, 50,000 ampere feet, and 3,000 ampere feet, respectively, for a total of 253,000 ampere feet. *Note that the length of run refers to the length of the physical circuit (i.e., circuit feet, not the footage of conductor).*

Factors are given at the bottom of each table to make the tables usable in any of the common AC circuits.

In busways, Tables 3.73 and 3.74 and Figures 3.39 through 3.41 show voltage drops per 100 feet at rated current (end loading) for the entire range of lagging power factors.

The voltage drop for a single-phase load connected to a three-phase system busway is 15.5 percent higher than the values shown in the tables. For a two-pole busway serving a single-phase load, the voltage drop values in Tables 3.73 and 3.74 should be multiplied by 1.08.

The tables show end-loaded conditions; that is, the entire load is concentrated at one end at rated capacity. Because plug-in types of busways are particularly adapted to serving the distributed blocks of load, care should be exercised to ensure proper handling of such voltage drop calculations. Thus, with uniformly distributed loading, the values in the tables should be divided by 2. When several separate blocks of load are tapped off the run at various points, the voltage drop should be determined for the first section using the total load. The voltage drop in the next section is then calculated using the total load minus what was tapped off in the first section, and so on.

Figure 3.42 shows the voltage drop curve versus power factor for typical light-duty trolley busway carrying rated load.

Figure 3.43 may be used to determine the approximate voltage drop in single-phase and three-phase 60-Hz liquid-filled, self-cooled transformers. The voltage drop through a single-phase transformer is found by entering the chart at a kilovolt-ampere value three times the rating of the single-phase transformer. Figure 3.43 covers transformers in the following ranges:

Single-phase

- 250 to 500 kVA, 8.6- to 15-kV insulation classes
- 833 to 1,250 kVA, 2.5- to 25-kV insulation classes

TABLE 3.73 Voltage Drop Values for Three-Phase Busways with Copper Bus Bars, in Volts per 100 Feet, Line-to-Line, at Rated Current with Balanced Entire Load at End

Rating (amperes)	20		30		40		50		Power Factor		80		90		95		100	
									60	70								
Low-voltage-drop ventilated feeder																		
800	3.66	3.88	4.04	4.14	4.20	4.20	4.16	3.92	3.60	2.72	2.70	2.62	2.30	2.30	2.30	2.30	2.30	2.30
1000	1.84	2.06	2.22	2.40	2.54	2.64	2.72	2.70	2.62	2.30	2.28	2.28	2.14	2.14	2.14	2.14	2.14	2.14
1350	2.24	2.44	2.62	2.74	2.86	2.94	2.96	2.90	2.78	2.30	2.30	2.30	2.14	2.14	2.14	2.14	2.14	2.14
1600	1.88	2.10	2.30	2.46	2.62	2.74	2.82	2.84	2.76	2.30	2.30	2.30	2.14	2.14	2.14	2.14	2.14	2.14
2000	2.16	2.34	2.52	2.66	2.78	2.84	2.90	2.80	2.68	2.30	2.30	2.30	2.14	2.14	2.14	2.14	2.14	2.14
2500	2.04	2.18	2.38	2.48	2.62	2.68	2.72	2.62	2.50	2.30	2.30	2.30	2.14	2.14	2.14	2.14	2.14	2.14
3000	1.96	2.12	2.28	2.40	2.52	2.58	2.60	2.52	2.40	2.30	2.30	2.30	2.14	2.14	2.14	2.14	2.14	2.14
4000	2.18	2.36	2.54	2.68	2.80	2.80	2.90	2.80	2.68	2.30	2.30	2.30	2.14	2.14	2.14	2.14	2.14	2.14
5000	2.00	2.16	2.30	2.40	2.50	2.60	2.68	2.60	2.40	2.30	2.30	2.30	2.14	2.14	2.14	2.14	2.14	2.14
Low-voltage-drop ventilated plug-in																		
800	6.80	6.86	6.92	6.86	6.72	6.52	6.04	5.26	4.64	2.76	2.76	2.76	2.76	2.76	2.76	2.76	2.76	2.76
1000	2.26	2.56	2.70	2.86	2.96	3.00	3.00	2.92	2.80	2.28	2.28	2.28	2.28	2.28	2.28	2.28	2.28	2.28
1350	2.98	3.16	3.32	3.38	3.44	3.46	3.40	3.22	3.00	2.32	2.32	2.32	2.32	2.32	2.32	2.32	2.32	2.32
1600	2.28	2.44	2.62	2.78	2.90	3.00	2.96	2.94	2.88	2.44	2.44	2.44	2.44	2.44	2.44	2.44	2.44	2.44
2000	2.58	2.78	2.92	3.02	3.10	3.16	3.08	3.00	2.82	2.28	2.28	2.28	2.28	2.28	2.28	2.28	2.28	2.28
2500	2.32	2.50	2.66	2.76	2.86	2.90	2.86	2.78	2.66	2.18	2.18	2.18	2.18	2.18	2.18	2.18	2.18	2.18
3000	2.18	2.34	2.48	2.60	2.70	2.74	2.72	2.66	2.58	2.10	2.10	2.10	2.10	2.10	2.10	2.10	2.10	2.10
4000	2.42	2.56	2.76	2.88	3.00	3.02	3.00	2.96	2.84	2.36	2.36	2.36	2.36	2.36	2.36	2.36	2.36	2.36
5000	2.22	2.30	2.48	2.60	2.70	2.76	2.74	2.68	2.60	2.16	2.16	2.16	2.16	2.16	2.16	2.16	2.16	2.16
Plug-in																		
225	2.82	2.94	3.04	3.12	3.18	3.18	3.10	2.86	2.70	2.04	2.04	2.04	2.04	2.04	2.04	2.04	2.04	2.04
400	4.94	5.08	5.16	5.18	5.16	5.02	4.98	4.30	3.94	2.64	2.64	2.64	2.64	2.64	2.64	2.64	2.64	2.64
600	5.24	5.34	5.40	5.40	5.36	5.00	4.50	4.20	3.62	2.92	2.92	2.92	2.92	2.92	2.92	2.92	2.92	2.92
800	5.06	5.12	5.16	5.06	5.00	4.74	4.50	3.84	3.32	1.94	1.94	1.94	1.94	1.94	1.94	1.94	1.94	1.94
1000	5.80	5.88	5.84	5.76	5.56	5.30	4.82	4.12	3.52	1.94	1.94	1.94	1.94	1.94	1.94	1.94	1.94	1.94
Trolley busway																		
100	1.2	1.38	1.58	1.74	1.80	2.06	2.20	2.30	2.30	2.18	2.18	2.18	2.18	2.18	2.18	2.18	2.18	2.18
Current-limiting ventilated																		
1000	12.3	12.5	12.3	12.2	11.8	11.1	10.1	8.65	7.45	3.8	3.8	3.8	3.8	3.8	3.8	3.8	3.8	3.8
1350	15.5	15.6	15.4	15.3	14.7	13.9	12.6	10.7	9.2	4.7	4.7	4.7	4.7	4.7	4.7	4.7	4.7	4.7
1600	18.2	18.2	18.0	17.5	16.6	15.6	14.1	11.5	9.5	4.0	4.0	4.0	4.0	4.0	4.0	4.0	4.0	4.0
2000	20.4	20.3	20.0	19.4	18.4	17.0	13.9	12.1	10.1	3.8	3.8	3.8	3.8	3.8	3.8	3.8	3.8	3.8
2500	23.8	23.6	23.0	22.2	21.0	19.2	17.2	13.5	10.7	3.8	3.8	3.8	3.8	3.8	3.8	3.8	3.8	3.8
3000	26.0	26.2	25.8	24.8	23.4	21.5	19.1	15.1	12.0	4.0	4.0	4.0	4.0	4.0	4.0	4.0	4.0	4.0
4000	29.1	28.8	28.2	27.2	25.6	25.2	21.0	16.6	13.0	4.1	4.1	4.1	4.1	4.1	4.1	4.1	4.1	4.1

Three-phase

- 225 to 750 kVA, 8.6- to 15-kV insulation classes
- 1,000 to 10,000 kVA, 2.5- to 25-kV insulation classes

APPLICATION TIPS

1. Always locate the source of the low-voltage supply (service transformer and service equipment, distribution transformers, distribution panels, generators, and UPS systems) as close to the center of the load as possible.
2. When you oversize a feeder or branch circuit for voltage drop compensation, note it as such on the design drawings. This prevents confusion for the electrical contractor(s) bidding and/or installing the work.
3. *Rule of thumb:* When the distance in circuit feet equals the nominal system voltage (e.g., you are at 120 circuit feet and the nominal system voltage is 120 V), it serves as a “flag” that you should check the voltage drop. In practice, experience has generally shown that it is safe to go another 50 percent in circuit feet without a voltage drop problem (180 circuit feet for the example given).
4. As is the case with short-circuit calculations, the only significant circuit impedance parameters generally needed for the voltage drop calculations are those of transformers, busways, and conductors in conduit. Devices such as switches, circuit breakers, transfer switches, and so forth, contribute negligible impedance and generally can be ignored.
5. The NEC recommends (not mandatory) that the voltage drop from the point-of-service entrance to the farthest extremity of the electrical distribution system not exceed 5 percent. With this guideline, it is generally good practice to limit the voltage drop to distribution panels to a maximum of 2 to 3 percent, leaving the remaining 2 to 3 percent for the smaller branch circuits to the extremities of the system. For example, limiting the voltage drop to 2 percent to a distribution panel would allow up to 3 percent voltage drop for the branch circuits served by that panel.

Voltage Dips—Momentary Voltage Variations

The previous discussion covered relatively slow changes in voltage associated with steady-state voltage spreads and tolerance limits. However, sudden voltage changes should be given special consideration. Lighting equipment output is sensitive to applied voltage, and people are sensitive to sudden changes in light. Intermittently operated equipment, such as compressor motors, elevators, x-ray machines, and flashing signs, may produce a flicker when connected to lighting circuits. Care should be

TABLE 3.74 Voltage Drop Values for Three-Phase Busways with Aluminum Bus Bars, in Volts per 100 Feet, Line-to-Line, at Rated Current with Balanced Entire Load at End

Rating (amperes)	Power Factor									
	20	30	40	50	60	70	80	90	95	100
Low-voltage-drop ventilated feeder										
800	1.68	1.96	2.20	2.46	2.68	2.88	3.04	3.12	3.14	2.90
1000	1.90	2.16	2.38	2.60	2.80	2.96	3.06	3.14	3.12	2.82
1350	1.88	2.20	2.48	2.74	3.02	3.24	3.44	3.56	3.58	2.38
1600	1.66	1.92	2.18	2.42	2.64	2.84	3.02	3.12	3.16	2.94
2000	1.82	2.06	2.30	2.50	2.70	2.88	3.02	3.10	3.04	2.80
2500	1.86	2.10	2.34	2.56	2.74	2.90	3.04	3.10	3.08	2.78
3000	1.76	2.06	2.26	2.52	2.68	2.86	2.98	3.06	3.04	2.78
4000	1.74	1.98	2.24	2.48	2.70	2.88	3.04	3.08	3.12	2.88
5000	1.72	1.98	2.20	2.42	2.62	2.80	2.92	3.02	3.02	2.80
Low-voltage-drop ventilated plug-in										
800	2.12	2.38	2.58	2.80	3.00	3.16	3.26	3.30	3.24	2.90
1000	2.44	2.66	2.86	3.06	3.22	3.36	3.42	3.38	3.28	2.84
1350	2.22	2.48	2.78	3.00	3.24	3.46	3.60	3.68	3.64	3.30
1600	1.82	2.12	2.38	2.62	2.80	2.96	3.08	3.16	3.14	2.88
2000	2.00	2.30	2.50	2.76	2.92	3.06	3.12	3.18	3.12	2.80
2500	2.00	2.28	2.50	2.70	2.92	3.02	3.12	3.16	3.08	1.78
3000	1.98	2.26	2.44	2.66	2.86	3.00	3.10	3.18	3.14	2.82
4000	1.94	2.20	2.48	2.64	2.86	3.00	3.12	3.18	3.16	2.88
5000	1.90	2.16	2.38	2.58	2.76	2.92	3.06	3.10	3.08	2.52



FIGURE 3.39 Voltage drop curves for typical interleaved construction of copper busway at rated load, assuming 70°C (158°F) as the operating temperature.

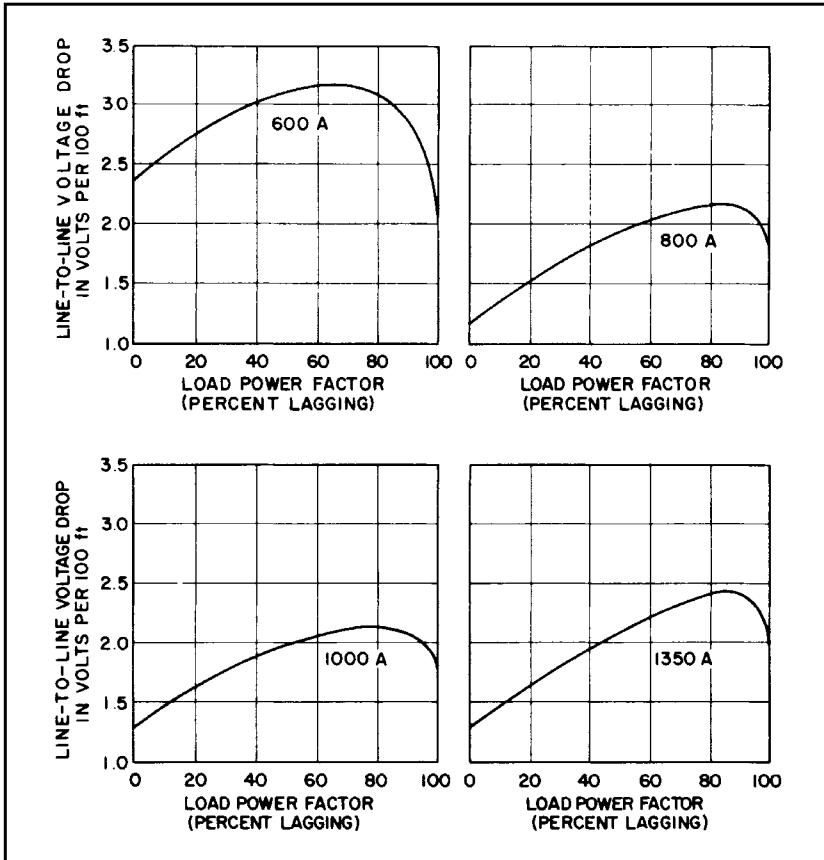

taken to design systems that will not irritate building occupants with flickering lights. In extreme cases, sudden voltage changes may even disrupt sensitive electronic equipment.

As little as a 0.5 percent voltage change produces a noticeable change in the output of an incandescent lamp. The problem is that individuals vary widely in their susceptibility to light flicker. Tests indicate that some individuals are irritated by a flicker that is barely noticeable to others. Studies show that sensitivity depends on how much illumination changes (magnitude), how often it occurs (frequency), and the type of work activity undertaken. The problem is further compounded by the fact that fluorescent and other lighting systems have different response characteristics to voltage changes (see previous parts of this section).

FIGURE 3.40 Voltage drop curves for typical plug-in-type busway at balanced rated load, assuming 70°C (158°F) as the operating temperature.

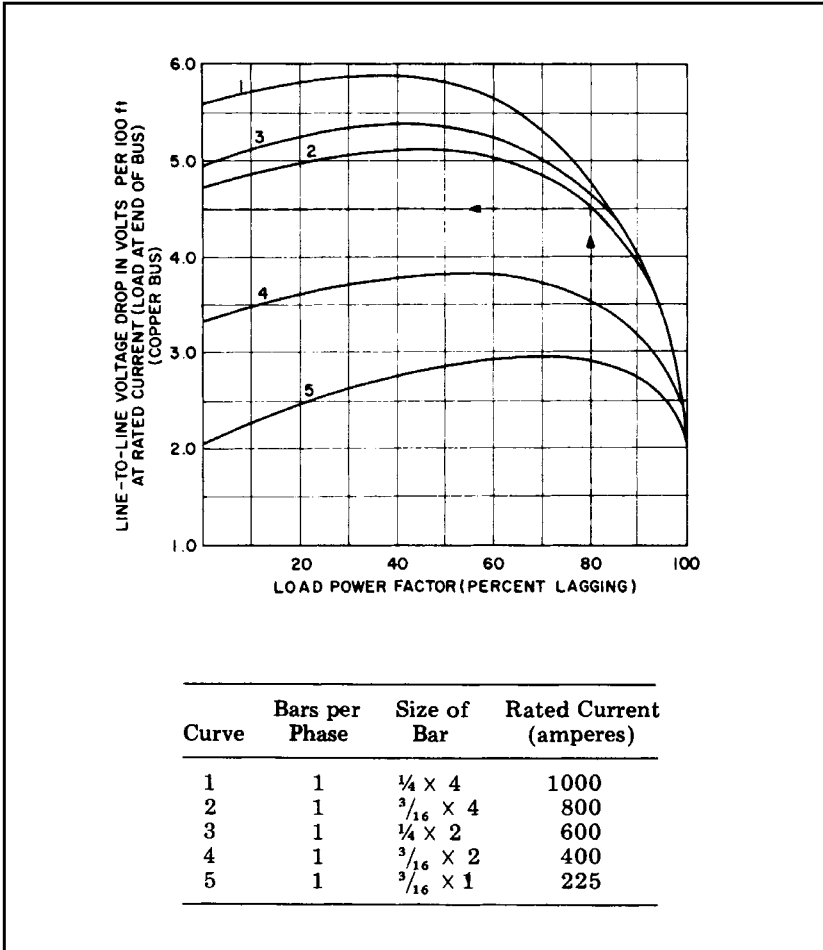

Illumination flicker can be especially objectionable if it occurs often and is cyclical.

Figure 3.44 shows acceptable voltage dip limits for incandescent lights. Two curves show how the acceptable voltage flicker magnitude depends on the frequency of occurrence. The lower curve shows a borderline where people begin to detect the flicker. The upper curve is the borderline where some people will find the flicker objectionable. At 10 dips per hour, people begin to detect incandescent lamp flicker for voltage dips larger than 1 percent and begin to object when the magnitude exceeds 3 percent.

FIGURE 3.41 Voltage drop curves for typical feeder busways at balanced rated load mounted flat horizontally, assuming 70°C (158°F) as the operating temperature.

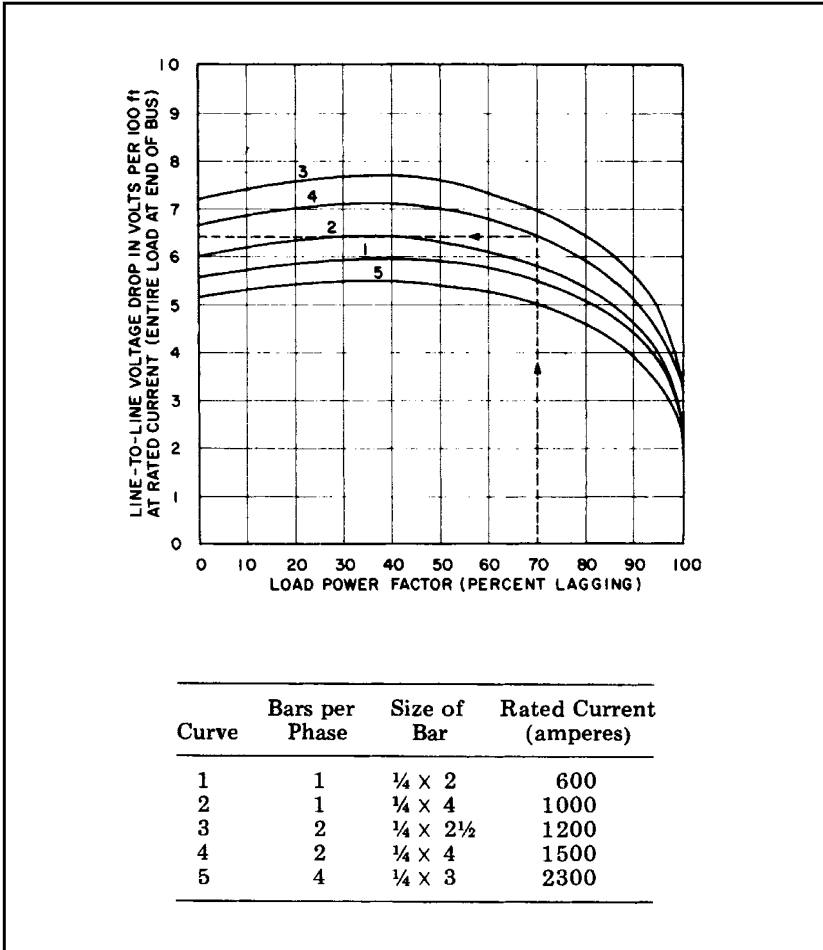

One source of voltage dips in commercial buildings is the inrush current while starting large motors on a distribution transformer that also supplies incandescent lights. A quick way to estimate flicker problems from motor starting is to multiply the motor locked-rotor starting kilovolt-ampere by the supply transformer impedance. A typical motor may draw 5 kVA/hp and a transformer impedance may be 6 percent. The equation below estimates flicker while starting a 15-hp motor on a 150-kVA transformer.

$$15 \text{ hp} \times 5 \text{ kVA/hp} \times 6\%/150 \text{ kVA} = 3\% \text{ flicker}$$

FIGURE 3.42 Voltage drop curve versus power factor for typical light-duty trolley busway carrying rated load, assuming 70°C (158°F) as the operating temperature.

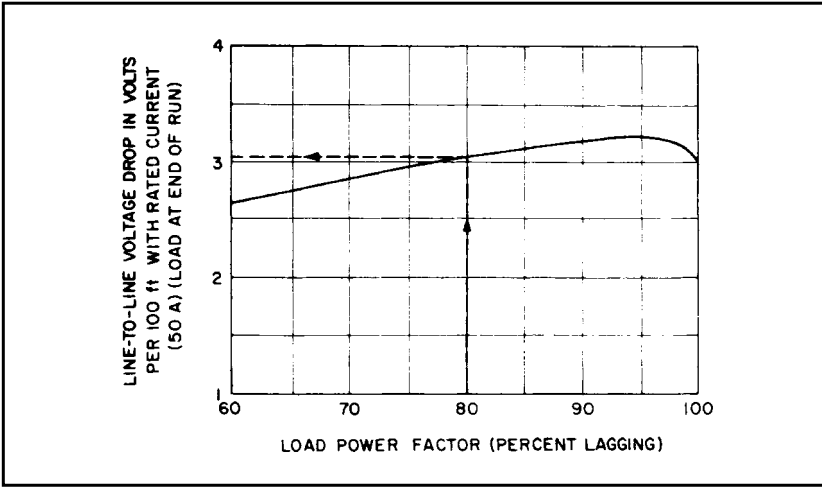

FIGURE 3.43 Voltage drop curves for three-phase transformers, 225 to 10,000 kVA, 5 to 25 kV. Note: This figure applies to 5.5 percent impedance transformers. For transformers of substantially different impedance, the information for the calculation should be obtained from the manufacturer.

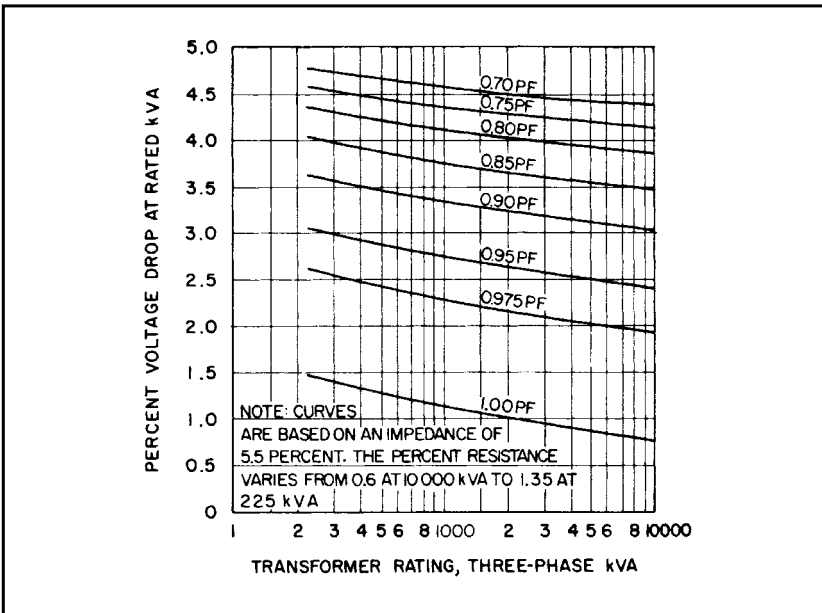
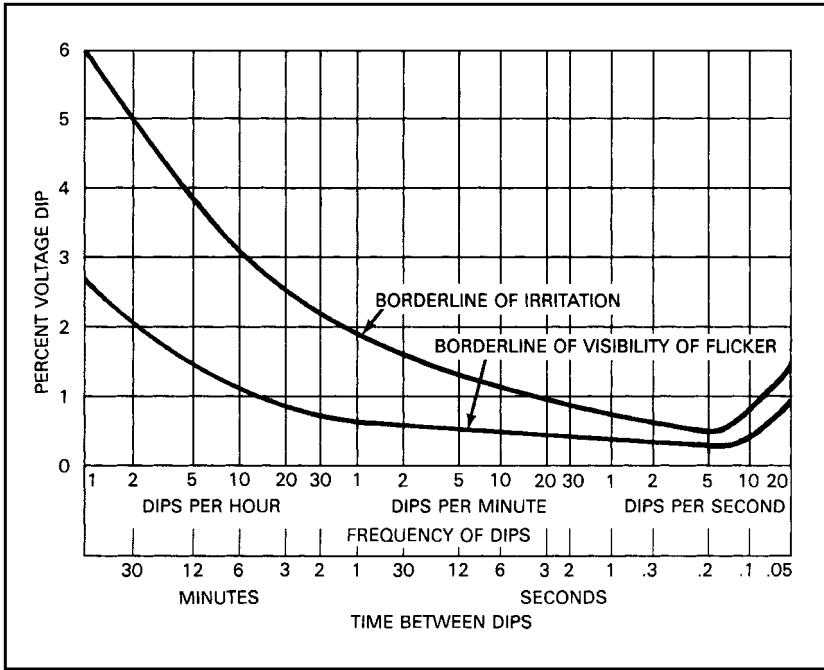

FIGURE 3.44 Flicker of incandescent lamps caused by recurrent voltage dips.



The estimated 3 percent dip associated with starting this motor reaches the borderline of irritation at 10 starts/hr. If the voltage dip combined with the starting frequency approaches the objectionable zone, more accurate calculations should be made using the actual locked-rotor current of the motor. Accurate locked-rotor kilovolt-amperes for motors are available from the motor manufacturer and from the starting code letter on the motor nameplate. The values for the code letters are listed in Table 3.39 of this handbook. More accurate methods for calculating motor-starting voltage dips are beyond the scope of this book.

One slightly more accurate method of quickly calculating voltage dip is to ratio the inrush current, or kilovolt-amperes, to the available short-circuit current, or kilovolt-amperes (if known), times 100 percent, to that point in the system of concern. This takes into account all impedance to the point in the system.

When the amount of the voltage dip in combination with the frequency falls within the objectionable range, then consideration should be given to methods of reducing the dip to acceptable values, such as using two or more smaller motors, providing a separate transformer for motors, separating motor feeders from other feeders, or using reduced-voltage motor starting.

3.10 THREE-PHASE FEEDER SIZE SCHEDULE

TABLE 3.75 Table 3.75 provides 3-phase, 3-wire and 3-phase, 4-wire feeder sizes based on the rating of the overcurrent protective device.

3 PHASE FEEDER SIZE SCHEDULE						
(COPPER CONDUCTORS)						
CIRCUIT SYMBOL	CONDUCTORS (3 PHASE, 3 WIRE) WITH GROUND*	SIZE CONDUIT	CONDUCTORS (3 PHASE, 4 WIRE) WITH GROUND*	SIZE CONDUIT	CIRCUIT OR OVERCURRENT RATING 3POLE	
(1)	3#12&1 #12G.	3/4"	4#12&1 #12G.	3/4"	15A.	
(2)	3#12&1 #12G.	3/4"	4#12&1 #12G.	3/4"	20A.	
(2/3)	3#10&1 #10G.	3/4"	4#10&1 #10G.	3/4"	25A.	
(3)	3#10&1 #10G.	3/4"	4#10&1 #10G.	3/4"	30A.	
(3/3)	3#8&1 #10G.	3/4"	4#8&1 #10G.	1"	35A.	
(4)	3#8&1 #10G.	3/4"	4#8&1 #10G.	1"	40A.	
(4/3)	3#6&1 #10G.	1"	4#6&1 #10G.	1"	45A.	
(5)	3#6&1 #10G.	1"	4#6&1 #10G.	1"	50A.	
(6)	3#4&1 #10G.	1 1/4"	4#4&1 #10G.	1 1/4"	60A.	
(7)	3#4&1 #8G.	1 1/4"	4#4&1 #8G.	1 1/4"	70A.	
(8)	3#3&1 #8G.	1 1/4"	4#3&1 #8G.	1 1/4"	80A.	
(9)	3#2&1 #8G.	1 1/4"	4#2&1 #8G.	1 1/2"	90A.	
(10)	3#1&1 #8G.	1 1/2"	4#1&1 #8G.	2"	100A.	
(11)	3#1&1 #6G.	1 1/2"	4#1&1 #6G.	2"	110A.	
(12)	3#1/0&1 #6G.	2"	4#1/0&1 #6G.	2"	125A.	
(15)	3#1/0&1 #6G.	2"	4#1/0&1 #6G.	2"	150A.	
(17)	3#2/0&1 #6G.	2"	4#2/0&1 #6G.	2"	175A.	
(20)	3#3/0&1 #6G.	2"	4#3/0&1 #6G.	2 1/2"	200A.	
(22)	3#4/0&1 #4G.	2 1/2"	4#4/0&1 #4G.	2 1/2"	225A.	
(25)	3#250KCM&1 #4G.	2 1/2"	4#250KCM&1 #4G.	3"	250A.	
(30)	3#350KCM&1 #4G.	3"	4#350KCM&1 #4G.	3"	300A.	
(35)	3#500KCM&1 #3G.	3 1/2"	4#500KCM&1 #3G.	4" **	350A.	
(40)	3#500KCM&1 #3G.	3 1/2"	4#500KCM&1 #3G.	4" **	400A.	
(45)	6#4/0&2 #2G.	(2)2 1/2"	8#4/0&2 #2G.	(2)2 1/2"	450A.	
(50)	6#250KCM&2 #2G.	(2)2 1/2"	8#250KCM&2 #2G.	(2)3"	500A.	
(60)	6#350KCM&2 #1G.	(2)3"	8#350KCM&2 #1G.	(2)3"	600A.	
(70)	6-500KCM&2 #1/0G.	(2)3 1/2"	8-500KCM&2 #1/0G.	(2)4" **	700A.	
(80)	6-500KCM&2 #1/0G.	(2)3 1/2"	8-500KCM&2 #1/0G.	(2)4" **	800A.	
(90)	9-350KCM&3 #2/0G.	(3)3"	12-350KCM&3 #2/0G.	(3)3"	900A.	
(100)	9-500KCM&3 #2/0G.	(3)3 1/2"	12-500KCM&3 #2/0G.	(3)4" **	1000A.	
(120)	9-600KCM&3 #3/0G.	(3)4"	12-600KCM&3 #3/0G.	(3)4"	1200A.	
(160)	12-600KCM&4 #4/0G.	(4)4"	16-600KCM&4 #4/0G.	(4)4"	1600A.	
(200)	15-600KCM&5 #250KCM,G.	(5)4"	20-600KCM&5 #250KCM,G.	(5)4"	2000A.	
(250)	18-600KCM&6 #350KCM,G.	(6)4"	24-600KCM&6 #350KCM,G.	(6)4"	2500A.	
(300)	24-500KCM&8 #500KCM,G.	(8)3 1/2"	32-500KCM&8 #500KCM,G.	(8)4" **	3000A.	
(320)	24-600KCM&8 #500KCM,G.	(8)4"	32-600KCM&8 #500KCM,G.	(8)4"	3200A.	
(350)	30-500KCM&10 #500KCM,G.	(10)3 1/2"	40-500KCM&10 #500KCM,G.	(10)4" **	3500A.	
(400)	30-600KCM&10 #500KCM,G.	(10)4"	40-600KCM&10 #500KCM,G.	(10)4"	4000A.	

TABLE 3.75 Table 3.75 provides 3-phase, 3-wire and 3-phase, 4-wire feeder sizes based on the rating of the overcurrent protective device. (*Continued*)

CIRCUIT SIZE SCHEDULE NOTES:

- | | |
|--|--|
| <p>S1. UNLESS OTHERWISE INDICATED, FEEDER SIZING SHALL MATCH THE SIZE INDICATED ABOVE FOR THE APPLICABLE OVERCURRENT DEVICE. PROVIDE LARGER FEEDER WHERE INDICATED.</p> <p>S2. SCHEDULE IS BASED ON TYPE THHN/THWN FOR CONDUCTOR SIZES SMALLER THAN #3 AWG AND TYPE XHHW FOR CONDUCTOR SIZES #3 AWG AND LARGER.</p> <p>S3. PROVIDE 4 WIRE CIRCUIT UNLESS DEVICE SERVED DOES NOT HAVE PROVISIONS FOR A NEUTRAL CONNECTION.</p> <p>S4. MINIMUM SIZE CONDUIT UNDERGROUND IS 4 INCH EXCEPT 1 INCH FOR SITE BRANCH CIRCUITS FOR LIGHTING AND MISCELLANEOUS POWER AND SYSTEMS, UNLESS SPECIFICALLY INDICATED OTHERWISE.</p> <p>S5. REFER TO TRANSFORMER SCHEDULE FOR CONDUCTOR AND CONDUIT SIZE REQUIREMENTS FOR PRIMARY AND SECONDARY FEEDERS.</p> <p>S6. REFER TO MOTOR CIRCUIT SCHEDULE FOR CONDUCTOR AND CONDUIT SIZE REQUIREMENTS FOR MOTOR LOADS.</p> <p>S6. CONDUIT SIZES ARE BASED ON MOST RESTRICTIVE RACEWAY TYPE AND ON NORMAL PRACTICES FOR ANTICIPATED METHODS OF INSTALLATION.</p> | <p>* CONDUCTOR SIZES ARE BASED ON 60°C TEMPERATURE RATING FOR BREAKER SIZES 100A AND SMALLER AND BASED ON 75°C TEMPERATURE RATING FOR BREAKER SIZES LARGER THAN 100A. NOT MORE THAN THREE CURRENT CARRYING CONDUCTORS SHALL BE PROVIDED IN RACEWAY, CABLE OR EARTH (DIRECT BURY), BASED ON AMBIENT TEMPERATURE OF 30°C, UNLESS OTHERWISE NOTED.</p> <p>** CONDUIT SIZES ARE MORE RESTRICTIVE THAN ALLOWED BY CODE. RACEWAY DIAMETER MAY BE DECREASED BY ONE SIZE AND MEET THE FILL LIMITATIONS OF THE MOST RESTRICTIVE RACEWAY MATERIAL.</p> |
|--|--|

CHAPTER FOUR

Grounding and Ground Fault Protection

4.0 GROUNDING

Introduction

Grounding encompasses several different but interrelated aspects of electrical distribution system design and construction, all of which are essential to the safety and proper operation of the system and equipment supplied by it. Among these are equipment grounding, system grounding, static and lightning protection, and connection to earth as a reference (zero) potential.

Equipment Grounding

Equipment grounding is essential to the safety of personnel. Its function is to ensure that all exposed noncurrent-carrying metallic parts of all structures and equipment in or near the electrical distribution system are at the same potential, and that is the zero reference potential of the earth. Grounding is required by both the National Electrical Code (Article 250) and the National Electrical Safety Code.

Equipment grounding also provides a return path for ground fault currents, permitting protective devices to operate effectively. Accidental contact of an energized conductor of the system with an improperly grounded noncurrent-carrying metallic part of the system (such as a motor frame or panelboard enclosure) would raise the potential of the metal object above ground potential. Any person coming in contact with such an object while grounded could be seriously injured or killed. In addition, current flow from the accidental grounding of an energized part of the system could generate sufficient heat (often with arcing) to start a fire.

To prevent the establishment of such an unsafe potential difference requires that (1) the equipment-grounding conductor provide a return path for the ground fault currents of sufficiently low impedance to prevent unsafe voltage drop (i.e., voltage rise due to the IZ drop), and (2) the equipment-grounding conductor be large enough to carry the

maximum ground fault current, without burning off, for sufficient time to allow protective devices (ground fault relays, circuit breakers, fuses) to clear the fault. The grounded conductor of the system (usually the neutral conductor), although grounded at the source, must not be used for equipment grounding.

The equipment-grounding conductor may be the metallic conduit or raceway of the wiring system, or a separate equipment-grounding conductor, run with the circuit conductors, as permitted by the NEC. For minimum-size equipment-grounding conductors for grounding raceway and equipment, see Table 4.1. If a separate equipment-grounding conductor is used, it may be bare or insulated; if it is insulated, the insulation must be green. Conductors with green insulation may not be used for any purpose other than for equipment grounding. Where conductors are run in parallel in multiple raceways or cables, the equipment-grounding conductor, where used, shall be run in parallel. Each parallel equipment-grounding conductor shall be sized in accordance with Table 4.1 (NEC Table 250.122).

The equipment-grounding system must be bonded to the grounding electrode at the source or service; however, it may also be connected to ground at many other points. This will not cause problems with the safe operation of the electrical distribution system. Where computers, data processing, or microprocessor-based industrial process control systems are installed, the equipment-grounding system must be designed to minimize interference with their proper operation. Often, isolated grounding of this equipment, or completely isolated electrical supply systems are required to protect microprocessors from power system “noise” that does not in any way affect motors or other electrical equipment.

Low-Voltage System Grounding

System grounding connects the electrical supply, from the utility, from transformer secondary windings, or from a generator, to ground. A system can be solidly grounded (no intentional impedance to ground), impedance-grounded (through a resistance or reactance), or ungrounded (with no intentional connection to ground).

The most commonly used grounding point is the neutral of the system, or the neutral point, created by means of a zigzag-wye or an open-delta grounding transformer in a system that was operating as an ungrounded-delta system.

In general, it is a good practice that all source neutrals be grounded with the same grounding impedance. Where one of the medium-voltage sources is the utility, their consent for impedance grounding must be obtained.

The neutral impedance must have a voltage rating at least equal to the rated line-to-neutral voltage class of the system. It must have at least

TABLE 4.1 NEC Table 250.122: Minimum Size of Equipment Grounding Conductors for Grounding Raceway and Equipment

Rating or Setting of Automatic Overcurrent Device in Circuit Ahead of Equipment, Conduit, etc., Not Exceeding (Amperes)	Size (AWG or kcmil)	
	Copper	Aluminum or Copper-Clad Aluminum*
15	14	12
20	12	10
30	10	8
40	10	8
60	10	8
100	8	6
200	6	4
300	4	2
400	3	1
500	2	1/0
600	1	2/0
800	1/0	3/0
1000	2/0	4/0
1200	3/0	250
1600	4/0	350
2000	250	400
2500	350	600
3000	400	600
4000	500	800
5000	700	1200
6000	800	1200

Note: Where necessary to comply with 250.4(A)(5) or 250.4(B)(4), the equipment grounding conductor shall be sized larger than given in this table.

*See installation restrictions in 250.120.

a 10-s rating equal to the maximum future line-to-ground fault current and a continuous rating to accommodate the triplen harmonics that may be present.

Solidly grounded three-phase systems (Figure 4.1) are usually wye-connected, with the neutral point grounded. Less common is the *red-leg*, or *high-leg*, delta, a 240-V system supplied by some utilities with one winding center-tapped to provide 120 V to ground for lighting and receptacles. This 240-V, three-phase, four-wire system is used where a 120-V lighting load is small compared with a 240-V power load, because the installation is low in cost to the utility. A corner-grounded, three-phase delta system is sometimes found, with one phase grounded to stabilize all voltages to ground. Better solutions are available for new installations.

Ungrounded systems (Figure 4.2) can be either wye or delta, although the ungrounded delta system is far more common.

Resistance-grounded systems (Figure 4.3) are simplest with a wye connection, grounding the neutral point directly through the resistor. Delta systems can be grounded by means of a zigzag or other grounding transformer. Open-delta transformer banks may also be used.

This drives a neutral point, which can be either solidly or impedance-

FIGURE 4.1 Solidly grounded systems.

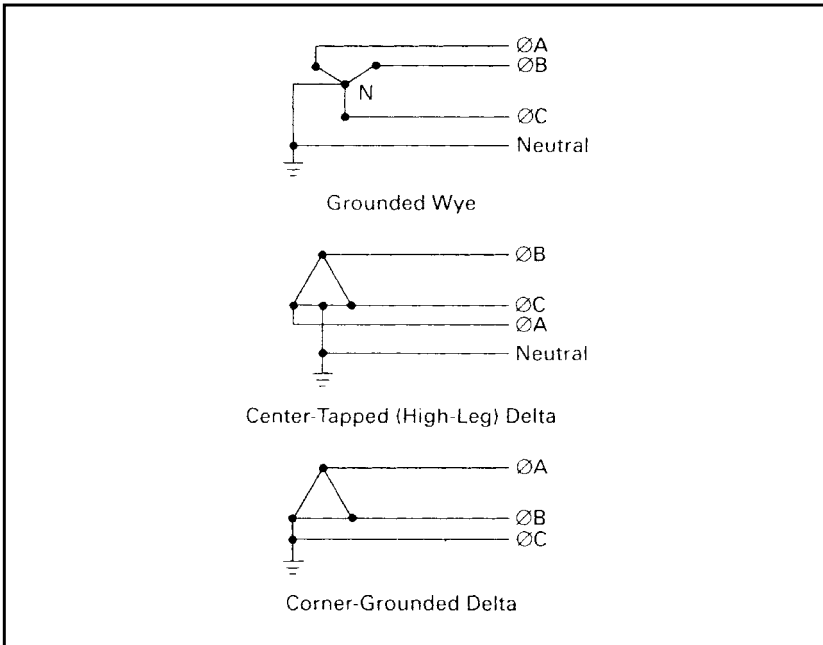
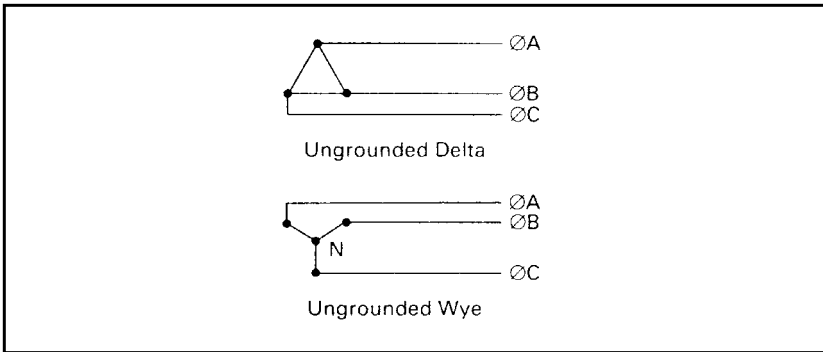
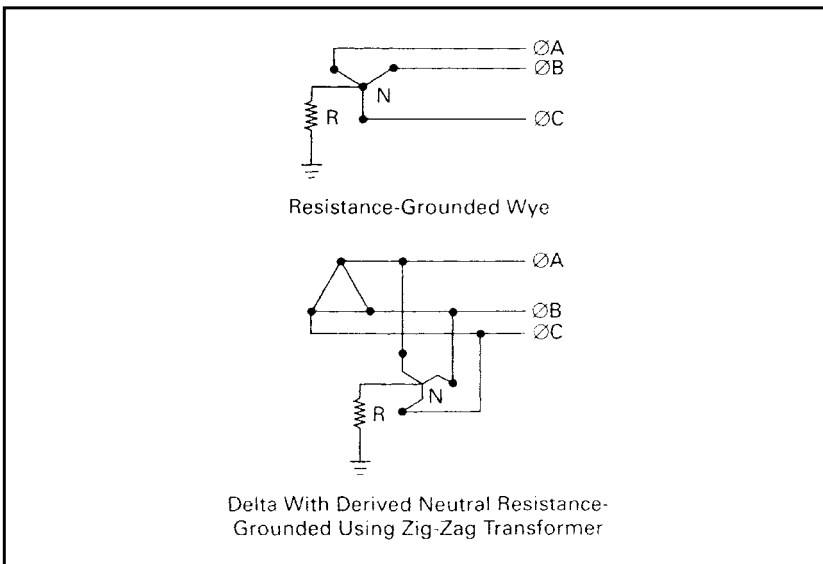

FIGURE 4.2 Ungrounded systems.



grounded. If the grounding transformer has sufficient capacity, the neutral created can be solidly grounded and used as a part of a three-phase, four-wire system. Most transformer-supplied systems are either solidly grounded or resistance-grounded. Generator neutrals are often grounded through a reactor, to limit ground fault (zero sequence) currents to values the generator can withstand. Generators that operate in parallel are sometimes resistance-grounded to suppress circulating harmonics.

FIGURE 4.3 Resistance-grounded systems.



Grounding-Electrode System

At some point, the equipment and system grounds must be connected to earth by means of a grounding-electrode system.

Outdoor substations usually use a ground grid, consisting of a number of ground rods driven into the earth and bonded together by buried copper conductors. The required grounding-electrode system for a building is spelled out in the NEC, Article 250, Part III. The preferred grounding electrode is a metal underground water pipe in direct contact with the earth for at least 10 ft. However, because underground water piping is often plastic outside of the building, or may later be replaced by plastic piping, the NEC requires this electrode to be supplemented by and bonded to at least one other grounding electrode, such as the effectively grounded metal frame of the building, a concrete-encased electrode, a copper conductor ground ring encircling the building, or a made electrode such as one or more driven ground rods or a buried plate. Where any of these electrodes are present, they must be bonded together into one grounding-electrode system.

One of the most effective grounding electrodes is the concrete-encased electrode, sometimes called the Ufer ground, after the man who developed it. It consists of at least 20 ft of steel reinforcing bars or rods not less than $\frac{1}{2}$ in in diameter, or at least 20 ft of bare copper conductor, size #4 AWG or larger, encased in at least 2 in of concrete. It must be located within and near the bottom of a concrete foundation or footing that is in direct contact with earth. Tests have shown this electrode to provide a low-resistance earth ground even in poor soil conditions.

The electrical distribution system and equipment ground must be connected to this grounding-electrode system by a grounding-electrode conductor. All other grounding electrodes, such as those for the lightning protection system, the telephone system, television antenna and cable TV system grounds, and computer systems, must be bonded to this grounding-electrode system.

The NEC requires a grounding-electrode system, illustrated by Figure 4.4 as an example, with the grounding-electrode conductor sized in accordance with Table 4.2 Grounding Electrode Conductor for AC Systems (NEC Table 250.66).

In general, where loads will be connected line to neutral, solidly grounded systems are used.

In commercial and institutional installations, such as office buildings, shopping centers, schools, and hospitals, lighting loads are often more than 50 percent of the total load. In addition, a feeder outage on the first ground fault is seldom crucial—even in hospitals, which have emergency power in critical areas. For these reasons, a solidly grounded wye distribution system, with the neutral used for lighting circuits, is usually the most economical, effective, and convenient design.

FIGURE 4.4 Grounding-electrode system (NEC Article 250.66).

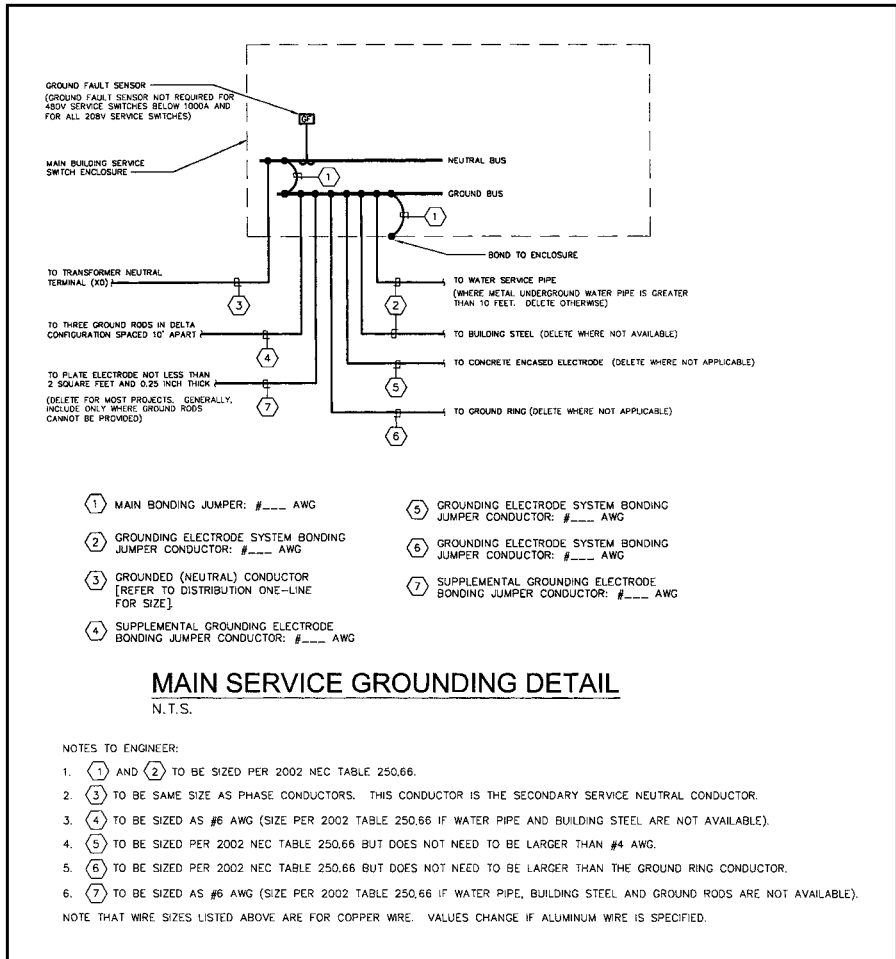

Medium-Voltage System Grounding

Because the method of grounding affects the voltage rise of the unfaulted phases above ground, ANSI C62.92 classifies systems from the point of view of grounding in terms of a coefficient of grounding (COG), which equals the highest power frequency rms line-to-ground voltage divided by the rms line-to-line voltage at the fault location with the fault removed.

This same standard also defines systems as effectively grounded when the COG is less than or equal to 0.8. Such a system would have X_0/X_1 less than or equal to 3.0 and R_0/X_1 less than or equal to 1.0. Any

TABLE 4.2 NEC Table 250.66: Grounding Electrode Conductor for Alternating-Current Systems

Size of Largest Ungrounded Service-Entrance Conductor or Equivalent Area for Parallel Conductors^a (AWG/kcmil)		Size of Grounding Electrode Conductor (AWG/kcmil)	
Copper	Aluminum or Copper-Clad Aluminum	Copper	Aluminum or Copper-Clad Aluminum^b
2 or smaller	1/0 or smaller	8	6
1 or 1/0	2/0 or 3/0	6	4
2/0 or 3/0	4/0 or 250	4	2
Over 3/0 through 350	Over 250 through 500	2	1/0
Over 350 through 600	Over 500 through 900	1/0	3/0
Over 600 through 1100	Over 900 through 1750	2/0	4/0
Over 1100	Over 1750	3/0	250

Notes:

1. Where multiple sets of service-entrance conductors are used as permitted in 230.40, Exception No. 2, the equivalent size of the largest service-entrance conductor shall be determined by the largest sum of the areas of the corresponding conductors of each set.

2. Where there are no service-entrance conductors, the grounding electrode conductor size shall be determined by the equivalent size of the largest service-entrance conductor required for the load to be served.

^aThis table also applies to the derived conductors of separately derived ac systems.

^bSee installation restrictions in 250.64(A).

TABLE 4.3 Characteristics of Grounding

Grounding Classes and Means	Ratios of Symmetrical Component Parameters ^①			Percent Fault Current	Per Unit Transient LG Voltage
	X_0/X_1	R_0/X_1	R_0/X_0		
A. Effectively ^④					^③
1. Effective	0-3	0-1	--	>60	≤2
2. Very effective	0-1	0-0.1	--	>95	<1.5
B. Noneffectively					
1. Inductance					
a. Low inductance	3-10	0-1		>25	<2.3
b. High inductance	>10		<2	<25	≤2.73
2. Resistance					
a. Low resistance	0-10		≥2	<25	<2.5
b. High resistance		>100	≤(-1)	<1	≤2.73
3. Inductance and resistance	>10	--	>2	<10	≤2.73
4. Resonant	^⑤	--	--	<1	≤2.73
5. Ungrounded/capacitance					
a. Range A	-∞ to -40 ^⑥	--	--	<8	≤3
b. Range B	-40 to 0	--	--	>8	>3 ^⑦

TABLE 4.4 Medium Voltage System Grounding Features of Ungrounded and Grounded Systems (from ANSI C62.92)

	A Ungrounded	B Solidly Grounded	C Reactance Grounded	D Resistance Grounded	E Resonant Grounded
(1) Apparatus Insulation	Fully insulated	Lowest	Partially graded	Partially graded	Partially graded
(2) Fault to Ground Current	Usually low	Maximum value rarely higher than three-phase short circuit current	Cannot satisfactorily be reduced below one-half or one-third of values for solid grounding	Low	Negligible except when Petersen coil is short circuited for relay purposes when it may compare with solidly-grounded systems
(3) Stability	Usually unimportant	Lower than with other methods but can be made satisfactory by use of high-speed breakers	Improved over solid grounding particularly if used at receiving end of system	Improved over solid grounding particularly if used at receiving end of system	Is eliminated from consideration during single line-to-ground faults unless neutralizer is short circuited to isolate fault by relays
(4) Relaying	Difficult	Satisfactory	Satisfactory	Satisfactory	Requires special provisions but can be made satisfactory
(5) Arcing Grounds	Likely	Unlikely	Possible if reactance is excessive	Unlikely	Unlikely
(6) Localizing Faults	Effect of fault transmitted as excess voltage on sound phases to all parts of conductively connected network	Effect of faults localized to system or part of system where they occur	Effect of faults localized to system or part of system where they occur unless reactance is quite high	Effect of faults transmitted as excess voltage on sound phases to all parts of conductively connected network	Effect of faults transmitted as excess voltage on sound phases to all parts of conductively connected network
(7) Double Faults	Likely	Likely	Unlikely unless reactance is quite high and insulation weak	Unlikely unless resistance is quite high and insulation weak	Seem to be more likely but conclusive information not available
(8) Lightning Protection	Ungrounded neutral service arresters must be applied at sacrifice in cost and efficiency	Highest efficiency and lowest cost	If resistance is very high arresters for ungrounded neutral service must be applied at sacrifice in cost and efficiency	Arresters for ungrounded, neutral service usually must be applied at sacrifice in cost and efficiency	Ungrounded neutral service arresters must be applied at sacrifice in cost and efficiency

(9) Telephone Interference	Will usually be low except in cases of double faults or electrostatic induction with neutral displaced but duration may be great May be quite high during faults or when neutral is displayed	Will be greatest in magnitude due to higher fault currents but can be quickly cleared particularly with high speed breakers Minimum	Will be reduced from solidly grounded values Greater than for solidly grounded, when faults occur	Will be reduced from solidly grounded values Greater than for solidly grounded, when faults occur	Will be low in magnitude except in cases of double faults or series resonance at harmonic frequencies, but duration may be great May be high during faults
(10) Ratio Interference	Will inherently clear themselves if total length of interconnected line is low and require isolation from system in increasing percentages as length becomes greater	Must be isolated for each fault	Must be isolated for each fault	Must be isolated for each fault	Need not be isolated but will inherently clear itself in about 60 to 80 percent of faults
(11) Line Availability	Cannot be interconnected unless interconnecting system is ungrounded or isolating transformers are used	Satisfactory indefinitely with reactance-grounded systems	Satisfactory indefinitely with solidly-grounded systems	Satisfactory with solidly- or reactance-grounded systems with proper attention to relaying	Cannot be interconnected unless interconnecting system is resonant grounded or isolating transformers are used. Requires coordination between interconnected systems in neutralizer settings
(12) Adaptability to Interconnection	Interrupting capacity determined by three-phase conditions	Same interrupting capacity as required for three-phase short circuit will practically always be satisfactory	Interrupting capacity determined by three-phase fault conditions	Interrupting capacity determined by three-phase fault conditions	Interrupting capacity determined by three-phase fault conditions
(13) Circuit Breakers	Ordinarily simple but possibility of double faults introduces complication in times of trouble	Simple	Simple	Simple	Taps on neutralizers must be changed when major system switching is performed and difficulty may arise in interconnected systems. Difficult to tell where faults are located
(14) Operating Procedure	High, unless conditions are such that arc tends to extinguish itself, when transmission circuits may be eliminated, reducing total cost	Lowest	Intermediate	Intermediate	Highest unless the arc suppressing characteristic is relied on to eliminate transmission circuits when it may be lowest for the particular types of service

other grounding means that does not satisfy these conditions at any point in the system is not effectively grounded.

The aforementioned definition is of significance in medium-voltage distribution systems with long lines and with grounded sources removed during light-load periods so that in some locations in the system the X_0/X_1 , R_0/X_1 ratios may exceed the defining limits.

Other standards (cable and lightning arrester) allow the use of 100 percent rated cables and arresters selected on the basis of an effectively grounded system only where the preceding criteria are met. In effectively grounded systems, the line-to-ground fault current is high, and there is no significant voltage rise in the unfaulted phases.

With selective ground fault isolation, the fault current will be at 60 percent of the three-phase current at the point of fault. Damage to cable shields must be checked. This fact is not a problem except in small cables. To prevent cable damage, it is a good idea to supplement cable shields as returns of ground fault current.

The burdens on the current transformers (CTs) must also be checked where residually connected ground relays are used and the CTs supply current to phase relays and meters. If ground sensor current transformers are used, they must also be of high-burden capacity.

Table 4.3 indicates the characteristics of the various methods of grounding.

Features of ungrounded and grounded systems are summarized in Table 4.4.

Reactance grounding is generally used in the grounding of generator neutrals, in which generators are directly connected to the distribution system bus, to limit the line-to-ground fault to somewhat less than the three-phase fault at the generator terminals. If the reactor is so sized, in all probability the system will remain effectively grounded.

When resistors are used in medium-voltage system grounding, they are generally low in resistance value. The fault is limited from 20 to 25 percent of the three-phase fault value down to about 400 A. With a properly sized resistor and relaying application, selective fault isolation is feasible. The fault limit provided has a bearing on whether residually connected relays are used or ground sensor current transformers are used for ground fault relaying.

In general, where residually connected relays are used, the fault current at each grounded source should not be limited to less than the current transformer's rating of the source. This rule will provide sensitive differential protection for wye-connected generators and transformers against line-to-ground faults near the neutral. Of course, if the installation of ground fault differential protection is feasible, or ground sensor current transformers are used, sensitive differential relaying in a resistance-grounded system with greater fault limitation is possible. In general, ground sensor current transformers do not have high-burden capacity. Resistance-grounded systems limit the circulating

currents of triplen harmonics and limit the damage at the point of fault. This method of grounding is not suitable for line-to-neutral connection of loads.

4.1 GROUND FAULT PROTECTION

Introduction

A ground fault normally occurs in one of two ways: by accidental contact of an energized conductor with normally grounded metal, or as a result of an insulation failure of an energized conductor. When an insulation failure occurs, the energized conductor contacts normally noncurrent-carrying metal, which is bonded to a part of the equipment-grounding conductor. In a solidly grounded system, the fault current returns to the source primarily along the equipment-grounding conductors, with a small part using parallel paths such as building steel or piping. If the ground return impedance were as low as that of the circuit conductors, ground fault currents would be high, and the normal phase-overcurrent protection would clear them with little damage. Unfortunately, the impedance of the ground return path is usually higher; the fault itself is usually arcing; and the impedance of the arc further reduces the fault current. In a 480Y/277-V system, the voltage drop across the arc can be from 70 to 140 V. The resulting ground fault current is rarely enough to cause the phase overcurrent protection device to open instantaneously and prevent damage. Sometimes, the ground fault is below the trip setting of the protective device and it does not trip at all until the fault escalates and extensive damage is done. For these reasons, low-level ground protection devices with minimum time-delay settings are required to rapidly clear ground faults. This is emphasized by the NEC requirement that a ground fault relay on a service shall have a maximum delay of 1 s for faults of 3000 A or more.

The NEC (Article 230.95) requires that ground fault protection, set at no more than 1200 A, be provided for each service-disconnecting means rated 1000 A or more on solidly grounded wye services of more than 150 V to ground, but not exceeding 600 V phase-to-phase. Practically, this makes ground fault protection mandatory on 480Y/277-V services, but not on 208Y/120-V services. On a 208-V system, the voltage to ground is 120 V. If a ground fault occurs, the arc will extinguish at current zero, and the voltage to ground is often too low to cause it to restrike. Therefore, arcing ground faults on 208-V systems tend to be self-extinguishing. On a 480-V system, with 277 V to ground, restrike usually takes place after current zero, and the arc tends to be self-sustaining, causing severe and increasing damage, until the fault is cleared by a protective device.

The NEC requires ground fault protection only on the service-disconnecting means. This protection works so fast that for ground faults on feeders, or even branch circuits, it will often open the service discon-

nect before the feeder or branch overcurrent device can operate. This is highly undesirable, and in the NEC (Article 230.95) a fine-print note (FPN) states that additional ground fault-protective equipment will be needed on feeders and branch circuits where maximum continuity of electric service is necessary. Unless it is acceptable to disconnect the entire service on a ground fault almost anywhere in the system, such additional stages of ground fault protection must be provided. At least two stages of ground fault protection are mandatory in health care facilities (NEC Article 517.17).

Overcurrent protection is designed to protect conductors and equipment against currents that exceed their ampacity or rating under prescribed time values. An overcurrent can result from an overload, short circuit, or high-level ground fault condition. When currents flow outside the normal current path to ground, supplementary ground fault protection equipment will be required to sense low-level ground fault currents and initiate the protection required. Normal phase-overcurrent protection devices provide no protection against low-level ground faults.

Basic Means of Sensing Ground Faults

There are three basic means of sensing ground faults. The most simple and direct method is the ground return method as illustrated in Figure 4.5. This sensing method is based on the fact that all currents supplied by a transformer must return to that transformer.

When an energized conductor faults to grounded metal, the fault current returns along the ground return path to the neutral of the source transformer. This path includes the grounding electrode conductor—sometimes called the ground strap—as shown in Figure 4.5. A current sensor on this conductor (which can be a conventional bar-type or window-type CT) will respond to ground fault currents only. Normal neutral currents resulting from unbalanced loads will return along the neutral conductor and will not be detected by the ground return sensor.

This is an inexpensive method of sensing ground faults in which only minimum protection per NEC Article 230.95 is desired. For it to operate properly, the neutral must be grounded in only one location, as indicated in Figure 4.5. In many installations, the servicing utility grounds the neutral at the transformer, and additional grounding is required in the service equipment. In such cases and others, including multiple source with multiple interconnected neutral ground points, residual or zero-sequence sensing methods should be employed.

A second method of detecting ground faults is the use of a zero-sequence sensing method as illustrated in Figure 4.6. This sensing method requires a single, specially designed sensor, either of a toroidal- or rectangular-shaped configuration. This core balance current transformer surrounds all the phase and neutral conductors in a typical three-phase, four-wire distribution system.

FIGURE 4.5 Ground return sensing method.

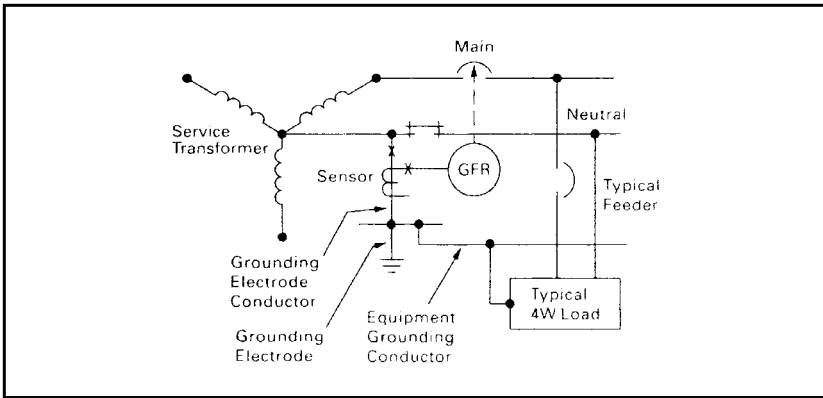

The sensing method is based on the fact that the vectorial sum of the phase and neutral currents in any distribution circuit will equal zero unless a ground fault condition exists downstream from the sensor. All currents that flow only in the circuit conductors, including balanced or unbalanced phase-to-phase and phase-to-neutral normal or fault currents, and harmonic currents, will result in zero sensor output. However, should any conductor become grounded, the fault current will return along the ground path—not the normal circuit conductors—and the sensor will have an unbalanced magnetic flux condition, and a sensor output will be generated to actuate the ground fault relay.

FIGURE 4.6 Zero-sequence sensing method.

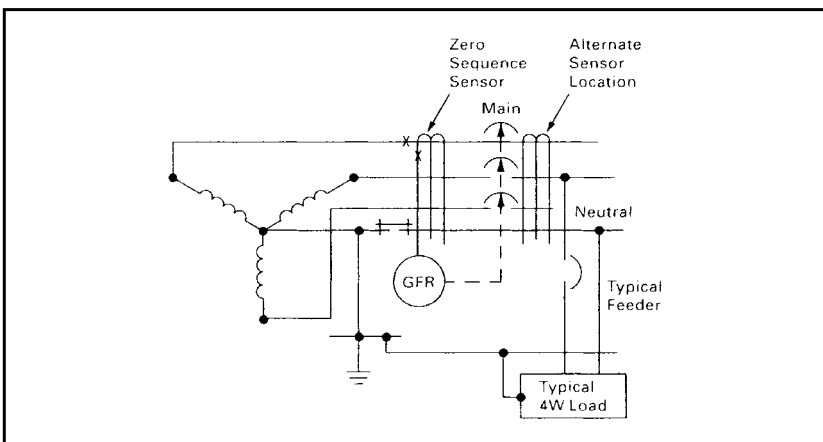

Zero-sequence sensors are available with various window openings for circuits with small or large conductors, and even with large rectangular windows to fit over bus bars or multiple large-size conductors in parallel. Some sensors have split cores for installations over existing conductors without disturbing the connections.

This method of sensing ground faults can be employed on the main disconnect where minimum protection per NEC Article 230.95 is desired. It can also be employed in multitier systems where additional ground fault protection is desired for added service continuity. Additional grounding points may be employed upstream of the sensor, but not on the load side.

Ground fault protection employing ground return or zero-sequence sensing methods can be accomplished by the use of separate ground fault relays (GFRs) and disconnects equipped with standard shunt trip devices or by circuit breakers with integral ground fault protection with external connections arranged for these modes of sensing.

The third basic method of detecting ground faults involves the use of multiple current sensors connected in a residual sensing method, as illustrated in Figure 4.7. This is a very common sensing method used with circuit breakers equipped with electronic trip units and integral ground fault protection. The three-phase sensors are required for normal phase-overcurrent protection. Ground fault sensing is obtained with the addition of an identically rated sensor mounted on the neutral. In a residual sensing scheme, the relationship of the polarity markings—as noted by the *X* on each sensor—is critical. Because the vectorial sum of the currents in all of the conductors will total zero under normal, nonground-faulted conditions, it is imperative that proper polarity connections are employed to reflect this condition.

FIGURE 4.7 Residual sensing method.

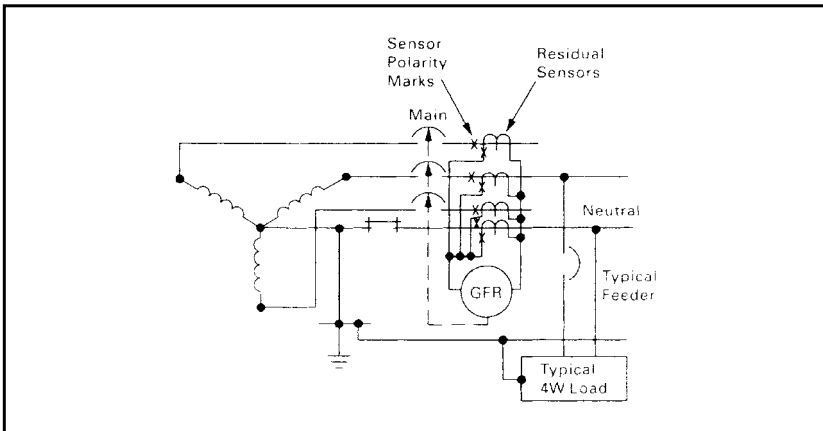

As with the zero-sequence sensing method, the resultant residual sensor output to the ground fault relay or integral ground fault tripping circuit will be zero if all currents flow only in the circuit conductors. Should a ground fault occur, the current from the faulted conductor will return along the ground path, rather than on the other circuit conductors, and the residual sum of the sensor outputs will not be zero. When the level of ground fault current exceeds the preset current and time-delay settings, a ground fault tripping action will be initiated.

This method of sensing ground faults can be economically applied on main-service disconnects, in which circuit breakers with integral ground fault protection are provided. It can be used in minimum-protection schemes per NEC Article 230.95 or in multitier schemes, in which additional levels of ground fault protection are desired for added service continuity. Additional grounding points may be employed upstream of the residual sensors, but not on the load side.

Both the zero-sequence and residual sensing methods have been commonly referred to as *vectorial summation* methods.

Most distribution systems can use any of the three sensing methods exclusively, or a combination of the sensing methods depending upon the complexity of the system and the degree of service continuity and selective coordination desired. Different methods will be required depending upon the number of supply sources and the number and location of system-grounding points.

As an example, one of the more frequently used systems in which continuity of service to critical loads is a factor is the dual-source system illustrated in Figure 4.8. This system uses tie-point grounding. The use of this grounding method is limited to services that are dual-fed (double-ended) in a common enclosure or grouped together in separate enclosures and employing a secondary tie.

This system uses individual sensors connected in ground-return fashion. Under tie breaker–closed operating conditions, either the M1 sensor or M2 sensor could see neutral unbalance current and possibly initiate an improper tripping operation. However, with the polarity arrangements of these two sensors, along with the tie breaker auxiliary switch (T/a) and the interconnections as shown, this possibility is eliminated. Selective ground fault tripping coordination between the tie breaker and the two main circuit breakers is achieved by preset current pickup and time-delay settings between devices GFR/1, GFR/2, and GFR/T.

The advantages of increased service continuity offered by this system can only be effectively used if additional levels of ground fault protection are added on each downstream feeder. Some users prefer individual grounding of the transformer neutrals. In such cases, a partial differential ground fault scheme should be used for the mains and the tie breaker.

An infinite number of ground fault protection schemes can be developed depending upon the number of alternate sources, the number of

FIGURE 4.8 Dual-source system—single-point grounding.

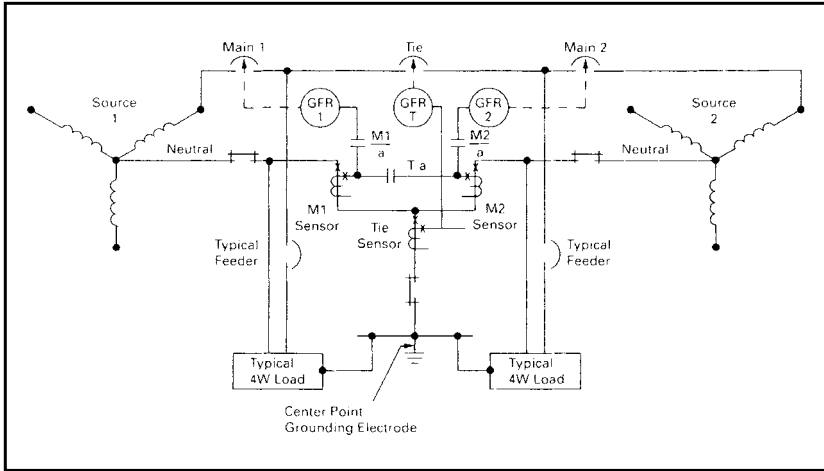

grounding points, and system interconnections involved. Depending upon the individual system configuration, either mode of sensing or a combination of all types may be employed to accomplish the desired end results.

Because the NEC Article 230.95 limits the maximum setting of the ground fault protection used on service equipment to 1200 A (or 3000 A for 1 s), to prevent tripping of the main-service disconnect on a feeder ground fault, ground fault protection must be provided on all the feeders. To maintain maximum service continuity, more than two levels (zones) of ground fault protection will be required, so that ground fault outages can be localized and service interruption minimized. To retain selectivity between different levels of ground fault relays, time-delay settings should be employed with the GFR furthest downstream having the minimum time delay. This will allow the GFR nearest the fault to operate first. With several levels of protection, this will reduce the level of protection for faults within the GFR zones. Zone interlocking was developed for GFRs to overcome this problem.

Ground fault relays (or circuit breakers with integral ground fault protection) with zone interlocking are coordinated in a system to operate in a time-delayed mode for ground faults occurring most remote from the source. However, this time-delayed mode is only actuated when the GFR next upstream from the fault sends a restraining signal to the upstream GFRs. The absence of a restraining signal from a downstream GFR is an indication that any occurring ground fault is within the zone of the GFR next upstream from the fault and that device will operate instantaneously to clear the fault with minimum damage and maximum

service continuity. This operating mode permits all GFRs to operate instantaneously for a fault within their zone and to still provide complete selectivity between zones. The National Electrical Manufacturers' Association (NEMA) states, in their application guide for ground fault protection, that zone interlocking is necessary to minimize damage from ground faults. A two-wire connection is required to carry the restraining signal from the GFRs in one zone to the GFRs in the next zone.

Circuit breakers with integral ground fault protection and standard circuit breakers with shunt trips activated by the ground fault relay are ideal for ground fault protection. Many fused switches over 1200 A, and some fusible switches in ratings from 400 to 1200 A, are listed by UL as suitable for ground fault protection. Fusible switches so listed must be equipped with a shunt trip and be able to open safely on faults up to 12 times their rating.

Power distribution systems differ widely from each other, depending on the requirements of each user, and total system overcurrent protection, including ground fault currents, must be individually designed to meet these needs. Experienced and knowledgeable engineers must consider the power sources (utility and on-site), the effects of outages and downtime, safety for people and equipment, initial and life-cycle costs, and many other factors. They must apply protective devices, analyzing the time-current characteristics, fault-interrupting capacity, and selectivity and coordination methods to provide the safest and most cost-effective distribution system.

4.2 LIGHTNING PROTECTION

Introduction

Lightning protection deals with the protection of buildings and other structures due to direct damage from lightning. Requirements will vary with geographic location, building type and environment, and many other factors. Any lightning protection system must be grounded, and the lightning protection ground must be bonded to the electrical equipment-grounding system. Installations must be installed in conformance with NFPA 780.

Nature of Lightning

Lightning is an electric discharge between clouds or between clouds and earth. Charges of one polarity are accumulated in the clouds and of the opposite polarity in the earth. When the charge increases to the point that the insulation between can no longer contain it, a discharge takes place. This discharge is evidenced by a flow of current, usually great in magnitude, but extremely short in time.

Damage to buildings and structures is the result of heat and mechanical forces produced by the passage of current through resistance in the path of discharge. Although the discharge takes place at the point at which the potential difference exceeds the dielectric strength of the insulation, which implies low resistance relative to other paths, it is not uncommon for the current to follow the path of high resistance. This may be a tree, a masonry structure, or a porcelain insulator. Obviously, damage due to direct stroke can be minimized by providing a direct path of low resistance to earth.

Lightning can cause damage to structures by direct stroke and to equipment by surges coming in over exposed power lines. Surges may be the result of direct strokes to the line at some distance away, or they may be electrostatically induced voltages.

Need for Protection

Damage to structures and equipment due to surge effect is a subject in itself, and protection against this type of damage is not within the scope of this text except as grounding is involved.

It is not possible to positively protect a structure against damage from a direct stroke except by completely enclosing it with metal. The extent to which lightning protection should be provided is governed by weighing the cost of protection against the possible consequences of being struck. The following factors are to be considered:

1. Frequency and severity of thunderstorms
2. Value and nature of structure or content
3. Personnel hazards
4. Consequential loss, such as a loss of production, salaries of workers, damage suits, and other indirect losses
5. Effect on insurance premiums

The above factors are listed primarily to call attention to their importance. No general conclusions can be drawn as to the relative importance of each or to the necessity for or the extent of lightning protection for any given combination of conditions. As a matter of interest, maps showing the frequency of thunderstorm days for various areas of the United States and Canada are shown in Figures 4.9 and 4.10. It should be noted, however, that the severity of storms is much greater in some local areas than in others, and, therefore, the need for protection is not necessarily in direct proportion to the frequency.

Equipment and Structures That Should Be Considered for Protection

The nature of buildings and their content is important in deciding whether lightning protection is desirable. Some of the structures that should be considered are as follows:

FIGURE 4.9 Annual isokeraunic map showing number of thunderstorm days per year (United States).

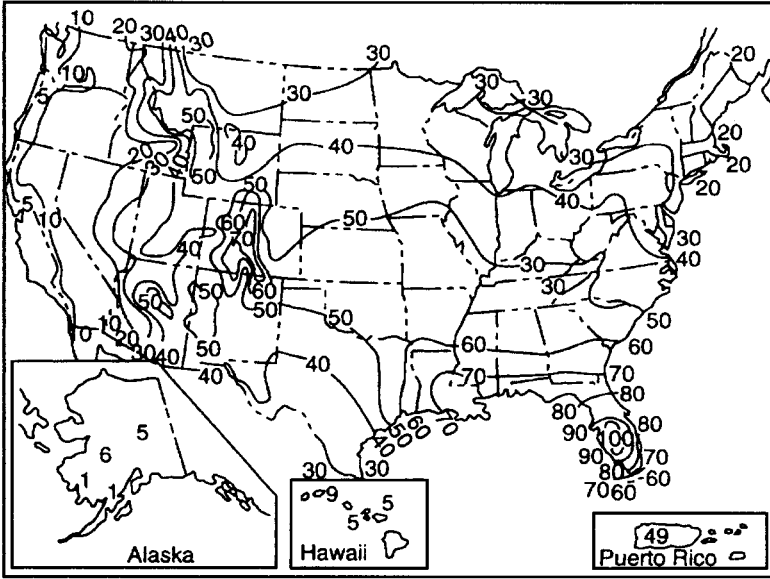
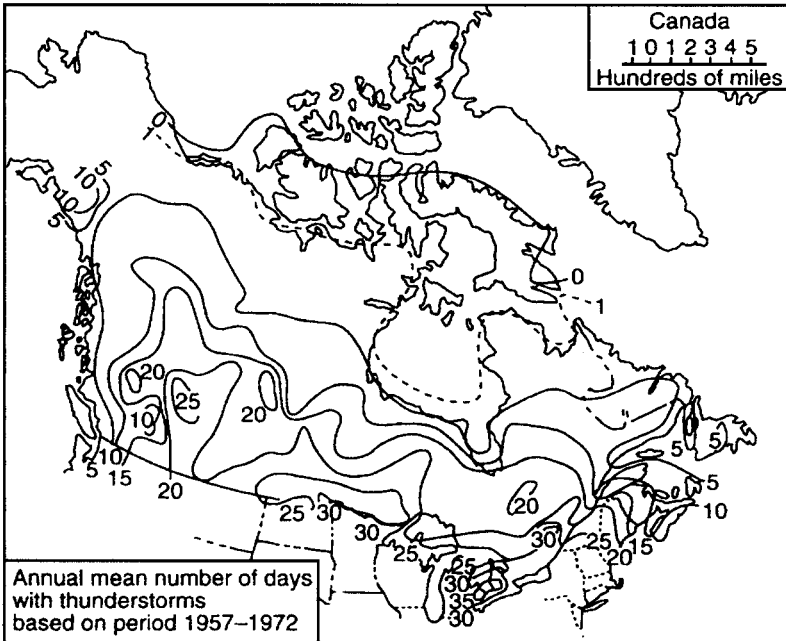

FIGURE 4.10 Annual isokeraunic map showing number of thunderstorm days per year (Canada).



- All-metal structures
- Metal-roofed and metal-clad buildings
- Metal-frame buildings with nonmetallic facings
- Buildings of wood, stone, brick, tile, and other nonconducting materials
- Spires, steeples, and flagpoles
- Buildings of historical value
- Buildings containing readily combustible or explosive materials
- Tanks and tank farms
- Transmission lines
- Power plants, substations, and water-pumping stations
- High stacks and chimneys
- Water towers, silos, and similar structures
- Buildings containing a significant amount of sensitive electronic equipment such as data centers
- Hospitals and health care facilities
- High-rise buildings

Metal buildings and structures offer a very satisfactory path to earth and require little in the way of additional protection. Metal-frame buildings with nonmetallic facings require more extensive measures. Buildings made entirely of nonconducting materials require complete lightning protection systems.

In special cases, buildings may have historical value out of proportion to their intrinsic value and may justify extensive protection systems. Power stations, substations, and water-pumping stations providing extremely important functions to outside facilities may demand protective measures far more extensive than would normally be warranted by the value of the structure. By the same token, structures containing combustible or explosive materials, liquids, and gases of a toxic nature or otherwise harmful to personnel or property if allowed to escape from their confining enclosures, may justify extensive protection systems.

Requirements for Good Protection

The fundamental theory of lightning protection of structures is to provide means by which a discharge may enter or leave the earth without passing through paths of high resistance. Such a condition is usually met by grounded steel-frame structures. Suitable protection is nearly always provided by the installation of lightning conductors.

A lightning conductor system consists of terminals projecting into the air above the uppermost parts of the structure, with interconnecting and ground conductors. Terminals should be placed so as to project above all points that are likely to be struck. Conductors should present the least possible impedance to earth. There should be no sharp bends or

loops. Each projecting terminal above the structure should have at least two connecting paths to earth and more if practicable.

Each conductor running down from the terminals on top of the structure should have an earth connection. Properly made connections to earth are an essential feature of a lightning rod system for protection of buildings. It is more important to provide ample distribution of metallic contacts in the earth than to provide low-resistance connections. Low-resistance connections are desirable, however, and should be provided where practicable. Earth connections should be made at uniform intervals about the structure, avoiding as much as possible the grouping of connections on one side. Electrodes should be at least 2 ft (0.6 m) away from and should extend below building foundations (except when using reinforcing bars for grounds). They should make contact with the earth from the surface downward to avoid flashing at the surface.

Interior metal parts of buildings or structures should be grounded independently, and if they are within 6 ft (1.8 m) of metallic roofs, walls, or conductors running down from the terminals on top of the structure, they should be securely connected thereto.

Terminals projecting above the structure should be of ample length to bring the top point at least 10 in (0.25 m) above the object to be protected. In many cases, a greater height is desirable. Experiments have indicated that a vertical conductor, or point, will divert to itself direct hits that might otherwise fall within a cone-shaped space, of which the apex is the point and the base is a circle whose radius is approximately equal to the height of the point (only for single aerial terminals).

The foregoing outlines requirements for good protection of buildings. Good protection of electrical substations, power stations, tanks and tank farms, and other special applications is beyond the scope of this book. For further information, refer to IEEE Standard 142.

Rolling-Ball Theory

The rolling-ball theory of protection (Figure 4.11) is a frequently used concept to determine the area of protection around a building or structure from lightning strikes. Basically, the zone of protection is thought to include the space not intruded on by the rolling ball, which has a radius of 150 feet (45.75 m). In other words, if the rolling ball were to touch two air terminals, there must be a gap between the bottom of the rolling ball and the structure to be in the zone of protection (ref.: NFPA 780, Section 3-10.3.1).

Cone of Protection

The area of protection for a well-grounded object is considered to be a conical zone (cone of protection) below and around such object that is based on a 45° angle or 30° from vertical (where appropriate), respectively.

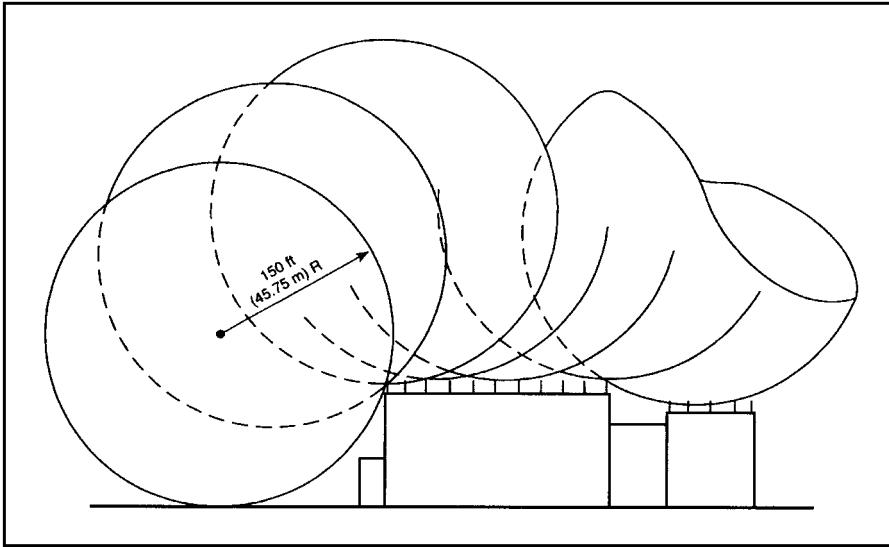
FIGURE 4.11 Rolling-ball theory.

In other words, the grounded object throws a protective “shadow” over and below things located within such shadow, and lightning strikes normally will not enter this shadow zone.

Application Tips

- As a practical matter, once it is decided that a lightning protection system is needed, consulting electrical engineers generally write a performance specification calling for a UL Master Label System. The system is actually designed and installed by a qualified lightning protection contractor.
- When considering a lightning protection system for a building, it is important to verify the history of frequency and severity of thunderstorms in the immediate area of the building being considered. This could be checked through the weather service and building owners in the local area.
- Experience has shown that adding a lightning protection system to a building increases its susceptibility to lightning strokes.
- If a lightning protection system is to be provided for a building addition, it must also be added to all existing contiguous buildings to obtain a UL Master Label. Even if the existing contiguous buildings already have a lightning protection system, their lightning protection system may have to be upgraded to obtain a UL Master Label.

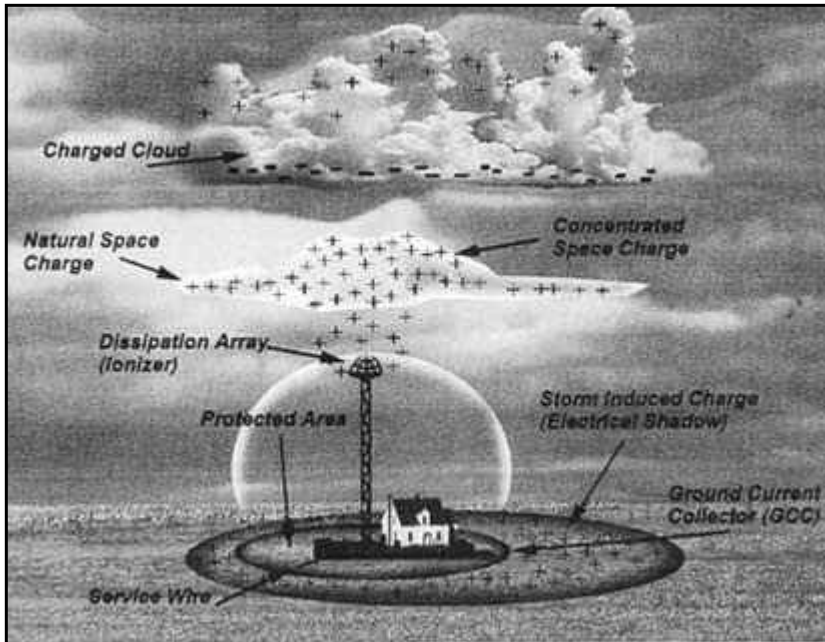
FIGURE 4.12 Dissipation array technology.

Dissipation Array System

The concept behind a traditional lightning protection system is to attract lightning and channel its energy into the ground. A charge transfer system, on the other hand, takes the opposite approach by attempting to prevent lightning from entering protected zones. A solution in the form of a dissipation array system (DAS) is provided by a company called Lightning Eliminators and Consultants, Inc., of Boulder, Colorado.

The DAS concept is based on a natural phenomenon known to scientists for centuries as the point discharge principle. A sharp point in an electrostatic field will leak off electrons by ionizing the adjacent air molecules, providing the point's potential is raised more than 10,000 volts above that of its surroundings.

The DAS employs the point discharge principle by providing thousands of points that simultaneously produce ions over a large area, thus preventing the formation of a streamer—the precursor to a lightning strike. This ionization process creates a flow of current from the point(s) into the surrounding air. The charge induced on the site by the storm is removed from the protected area and transferred to the air molecules, which then move away from the site. Thus a DAS prevents strikes by continually lowering the voltage differential between the ground and

the charged cloud to well below the lightning potential, even in the midst of a worst-case storm.

Because it prevents rather than redirects lightning, the DAS is possibly the best long-term solution to lightning strike problems. It is gaining wide acceptance through many very successful installations. It offers an excellent alternative to the traditional Franklin rod type system.

CHAPTER FIVE

Emergency and Standby Power Systems

5.0 GENERAL NEED FOR EMERGENCY AND STANDBY POWER SYSTEMS

Introduction

Emergency electric services are required for protection of life, property, or business where loss might be the result of an interruption of the electric service. The extent of the emergency services required depends on the type of occupancy, the consequences of a power interruption, and the frequency and duration of expected power interruptions.

Municipal, state, and federal codes define minimum requirements for emergency systems for some types of public buildings and institutions. These shall be adhered to, but economics or other advantages may result in making provisions beyond these minimums (see the NEC, Articles 517, 700, 701, and 702). The following presents some of the basic information on emergency and standby power systems. For additional information, design details, and maintenance requirements, see ANSI/IEEE Standard 446-1987 (“IEEE Recommended Practice for Emergency and Standby Power Systems for Industrial and Commercial Applications”), ANSI/NFPA 110 (“Emergency and Standby Power Systems”), and ANSI/NFPA 110A (“Stored Energy Systems”).

Emergency power systems should be separated from the normal power systems by using separate raceways and panelboards. The NEC requires that each item of emergency equipment be clearly marked as to its purpose. In large public buildings, physical separation of the emergency system from the normal system elements would enhance the reliability of the emergency system in the event of fire or other contingencies. Also, more and more states are requiring that the emergency systems not only be separated from the normal systems, but that they be enclosed in 2-h fire-rated construction.

Definitions

The following is intended to conveniently provide selected terms and definitions applicable to this chapter for the purpose of aiding in its overall understanding.

Automatic transfer switch: Self-acting equipment for transferring one or more load conductor connections from one power source to another.

Bypass/isolation switch: A manually operated device used in conjunction with an automatic transfer switch to provide a means of directly connecting load conductors to a power source and of disconnecting the automatic transfer switch.

Commercial power: Power furnished by an electric power utility company. When available, it is usually the prime power source; however, when economically feasible, it sometimes serves as an alternative or standby source.

Emergency power system: An independent reserve source of electric energy that, upon failure or outage of the normal source, automatically provides reliable electric power within a specified time to critical devices and equipment whose failure to operate satisfactorily would jeopardize the health and safety of personnel or result in damage to property.

Standby power system: An independent reserve source of electric energy that, upon failure or outage of the normal source, provides electric power of acceptable quality so that the user's facilities may continue in satisfactory operation.

Uninterruptible power supply (UPS): A system designed to automatically provide power, without delay or transients, during any period when the normal power supply is incapable of performing acceptably.

Lighting

Exit and emergency lights that are sufficient to permit safe exit from buildings in which the public may congregate should be supplied from an emergency power source (i.e., auditoriums, theaters, hotels, large stores and malls, sports arenas, and so on). Local regulations should always be referred to for more specific requirements. When the emergency lighting units are not used under normal conditions, power should be immediately available to them upon loss of the normal power supply. When the emergency lights are normally in service and served from the normal power supply, provisions should be made to transfer them automatically to the emergency power source when the normal power supply fails.

Sufficient lighting should be provided in stairs, exits, corridors, and halls so that the failure of any one unit will not leave any area dark or endanger persons leaving the building. Adequate lighting and rapid automatic transfer to prevent a period of darkness is important in public areas. Public safety is improved and the chance of pilfering or damage to property is minimized.

ANSI/NFPA 101 (“Life Safety Code”) requires that emergency power sources for lighting be capable of carrying their connected loads for at least 90 min. There are cases in which provisions should be made for providing emergency service for much longer periods of time, such as in health care facilities, communications, police, fire fighting, and emergency services. A 2- to 3-h capacity is more practical and, in many installations, a 5- to 6-h or even several-day capacity is provided. During a severe storm or catastrophe, the demands on hospitals, communications, police, fire fighting, and emergency service facilities will be increased. A third source of power to achieve the lighting reliability may be required.

When installation of a separate emergency power supply is not warranted but some added degree of continuity of service for exit lights is desired, they may be served from circuits connected ahead of the main service-entrance switch for some occupancies. This assures that load switching and tripping due to faults in the building’s electric system will not cause loss of the exit lights. However, this arrangement does not protect against failures in the electric utility system.

ILLUMINATION OF MEANS OF EGRESS

In its occupancy chapter, ANSI/NFPA 101 has illumination requirements for building egress, which includes stating the type of emergency lighting required.

Primary or normal illumination is required to be continuous during the time “the conditions of occupancy” require that the means of egress be available for use. ANSI/NFPA 101 specifies the illuminances and equipment for providing this type of lighting.

Emergency power sources listed in the NEC, Article 700 include the following:

1. Storage batteries (rechargeable type) to supply the load for 90 min without the voltage at the load decreasing to 87.5 percent of normal
2. Generator sets that will accept the emergency lighting load within 10 s, unless an auxiliary lighting source is available
3. Uninterruptible power supplies
4. Separate electric utility service, which is widely separated electrically and physically from the normal service

5. Unit equipment (permanently installed) consisting of a rechargeable storage battery, automatic charger, lamp(s), and automatic transfer relay.

Refer to the ANSI/NFPA 101, Sections 5-8 and 5-9 (“Illumination of Means of Egress” and “Emergency Lighting”), respectively.

Power Loads

An emergency source for supplying power loads is required when loss of such a load could cause extreme inconvenience or hazard to personnel, loss of product or material, or contamination of property. The size and type of the emergency system should be determined through consideration of the health and convenience factors involved and whether the utilization affects health care facilities, communication systems, alarm systems, police, fire fighting, and emergency services facilities. The installation should comply with any applicable codes and standards and be acceptable to the authority that has jurisdiction. For example, health care facilities may require conformance to ANSI/NFPA 99 (“Health Care Facilities”) and the NEC, Article 517. Fire pump installations may require conformance to ANSI/NFPA 20 (“Centrifugal Fire Pumps”).

In laboratories in which continuous processes are involved or in which chemical, biological, or nuclear experimentation is conducted, requirements are very demanding insofar as power and ventilating system requirements are concerned. Loss of adequate power for ventilation could permit the spread of poisonous gases, biological contamination, or radioactive contamination throughout the building, and can even cause loss of life. A building contaminated from radioactive waste could be a total loss or require extensive cleanup measures. Many processes or experiments cannot tolerate a power loss that could interrupt cooling, heating, agitation, and so forth.

Emergency power for fire pumps should be provided when water requirements cannot be met from other sources. Emergency power for elevators should also be considered when elevators are necessary to evacuate buildings or the cost seems warranted to avoid inconvenience to the public. This does not mean that the emergency power supply should have the full capacity for the demand of all elevators simultaneously.

Summary of Codes for Emergency Power in the United States

Table 5.1 is a guide to state codes and regulations for emergency power systems in the United States. All the latest codes and regulations for the area in which the industrial or commercial facility is located must be consulted and followed.

TABLE 5.1 Codes for Emergency Power by States and Major Cities (Completed September 1984)

State/City	Does State/City Have Legislation?	Legislation Code Type?	Hospitals	Nursing Homes	Schools	Theaters (Public Gathering Places)	Office Buildings	Hotels	Apartment Buildings	Airports	Fire and Police Stations	Water Treatment Plants	Sewage Treatment Plants	All Public Buildings, State	All Public Buildings, Commercial	Applicable Government Agency	Smokeproof Enclosures in High-Rise Buildings
Alabama	Yes	4,6	A,C,D	A,C,D	C,D	C,D	C,D	C,D	C,D	C,D				C,D	C,D	M,N,O	B
Birmingham	Yes	4,6	A,C,D	A,C,D	C,D	C,D	C,D	C,D	C,D	C,D	C	C	C	C,D	C,D	Q,S	A,B
Mobile	** Yes	1,4	A,C,D	A,C,D	C,D	A,C,D	A,C,D	A,C,D	A,C,D	C,D	C			C,D	C	S	
Alaska	Yes	1,3	A,C,D	A,C,D	A,C,D	A,C,D	A,C,D	A,C,D	A,C,D	A,C,D	C,D	C,D	C,D	C,D	A,C,D	M,P	B
Arizona	No																
Phoenix	** Yes	1	A,C,D	A,C,D	C,D	C,D	C,D		A,C,D					C,D	C,D	O	
Arkansas	Yes	1,6	A,C,D	A,C,D	A,C,D	A,C,D	A,C,D	A,C,D	A,C,D	A,C,D	C,D	C,D	C,D	C,D	A,C,D	M	B
California	Yes	2,3,4	A,C,D	A,C,D	C,D	C,D	C,D	C,D	C,D	C,D				C,D	C,D	O,T	A
Anaheim	Yes	2,3,4,7	A,C,D	A,C,D												M,N,O,Q	
Berkeley	** Yes	1,3	A,C,D	A,C,D	C,D	C,D	C,D	C,D	C,D	C,D		A,C,D	C,D	C,D	C,D	M,Q	
Fresno	Yes	3,4	A,C,D	A,C,D	A,C,D	A,C,D	A,C,D	A,C,D	A,C,D	A,C,D	C,D	C,D	C,D	C,D	C,D	O,S	B
Glendale	Yes	3,4	A,C,D	A,C,D	A,C,D	A,C,D	A,C,D	A,C,D	A,C,D	C,D	C,D			C,D	C,D	M,Q	B
Long Beach	** Yes	3	A,C,D	A,C,D	A,C,D	A,C,D	C,D	C,D	C,D	A,C,D	A,C,D	C,D	C,D	C,D	C,D	M,O	
Los Angeles	Yes	3,4,8	A,C,D	A,C,D	A,C,D	A,C,D	A,C,D	A,C,D	A,C,D	B,C,D	C,D	C,D	C,D	C,D	C,D	M,Q,S	B
Oakland	Yes	1,3,4,8	A,C,D	A,C,D	A,C,D	A,C,D	A,C,D	A,C,D	A,C,D	C,D	C,D	C,D	C,D	C,D	C,D	M,O	B
Pasadena	Yes	1,2,3,4	A,C,D	C,D	C,D	A,C,D	C,D	C,D	C,D	C,D	C,D	C,D	C,D	C,D	C,D	O,Q	
San Diego	Yes	3,4	A,C,D	A,C,D	A,C,D	A,C,D	A,C,D	A,C,D	A,C,D	C,D	C,D	C,D	C,D	C,D	C,D	S	B
San Francisco	Yes	3,4	A,C,D	A,C,D	C,D	A,C,D	A,C,D	A,C,D	A,C,D	A,C,D	C,D	C,D	C,D	C,D	C,D	O	B
San Jose	** Yes	4														M,S	
Santa Ana	** Yes	3,4														M,Q	
Colorado	Yes	3,4	A,C,D	A,C,D	C,D	C,D	A,C,D	A,C,D	A,C,D	C,D			C,D	C,D	C,D	Q	B
Denver	Yes	4,8	A,C,D	A,C,D	C,D	A,C,D	A,C,D	A,C,D	A,C,D	A,C,D				A,C,D	A,C,D	Q	B
Connecticut	Yes	2,4	A,C,D	A,C,D	A,C,D	A,C,D	A,C,D	A,C,D	A,C,D	C,D	C,D	C,D	C,D	C,D	C,D	P	A
Hartford	** Yes	2	A,C,D	A,C,D	A,C,D	A,C,D	A,C,D	A,C,D	A,C,D	A,C,D	A,C,D	A,C,D	A,C,D	A,C,D	A,C,D	M,R	
New Haven	** Yes	1,2,4	A,C,D	A,C,D	A,C,D	A,C,D	A,C,D	A,C,D	A,C,D	A,C,D	A,C,D	A,C,D	A,C,D	A,C,D	A,C,D	M,Q	
Delaware	Yes	1,2,4	A,C,D	A,C,D	C,D	C,D	C,D	C,D	C,D	C,D				C,D	C,D	M	A

NOTE: An explanation of the numbers and letters used is given at the end of the table.



TABLE 5.1 Codes for Emergency Power by States and Major Cities (Completed September 1984) (Continued)

State/City	Does State/City Have Legislation?	Legislation Code Type?	Hospitals	Nursing Homes	Schools	Theaters (Public Gathering Places)	Office Buildings	Hotels	Apartment Buildings	Airports	Fire and Police Stations	Water Treatment Plants	Sewage Treatment Plants	All Public Buildings, State	All Public Buildings, Commercial	Applicable Government Agency	Smokeproof Enclosures in High-Rise Buildings
District of Columbia	Yes	2,4	A,C,D	A,C,D	C,D	C,D	C,D	C,D	C,D	C,D	C,D	C,D	C,D	C,D	C,D	M,Q	A
Florida	Yes	1,2,4,6	A,C,D	A,C,D	C,D	C,D	C,D	C,D	C,D	C,D	C,D	C,D	C,D	C,D	C,D	M,O	A
Jacksonville	Yes	8	A,C,D	A,C,D	C,D	C,D	C,D	C,D	C,D	C,D	C,D	C,D	C,D	C,D	C,D	Q,S	
St. Petersburg	**	1,4,7	A,C,D	A,C,D	A,C,D	A,C,D	A,C,D	A,C,D	A,C,D	A,C,D				A,C,D	U		
Tampa	Yes	1,4,8	A,C,D	A,C,D	C,D	C,D	C,D	C,D	C,D	C,D	C,D	C,D	C,D	C,D	C,D	M	A
Georgia	Yes	1,4,7	A,C,D	A,C,D	C,D	C,D	C,D	C,D	C,D	A,C,D	B	B	C,D	C,D	C,D	M	
Atlanta	Yes	1,4,8	A,C,D	A,C,D	C,D	C,D	C,D	C,D	C,D	C,D	C,D	C,D	C,D	C,D	C,D	O	B
Columbus	**	4,6	A,C,D	B,C,D	B,C,D	B,C,D	C,D	B,C,D	C,D	C,D	C,D	C,D	C,D	C,D	C,D	S	
Savannah	Yes	4	A,C,D	A,C,D	C,D	C,D	C,D	C,D	C,D	C,D	C,D	C,D	C,D	C,D	C,D	S	
Hawaii	Yes	1,3	A,C,D	A,C,D	A,C,D	C,D	C,D	C,D	C,D	C,D	A,C,D	C,D	C,D	C,D	C,D	M,Q	B
Honolulu	Yes	1,3,8	A,C,D	A,C,D	C,D	C,D	C,D	C,D	C,D	C,D	C,D	C,D	C,D	C,D	C,D	M,Q	B
Idaho	Yes	1,3,4	A,C,D	A,C,D	C,D	A,C,D	A,C,D	C,D	C,D	C,D	C,D	C,D	C,D	C,D	C,D	M,R	B
Illinois	No	2	A,C,D	A,C,D	C,D	A,C,D	A,C,D	A,C,D	A,C,D	A,C,D	B	B	C,D	A,C,D	A,C,D	M,N	
Chicago	**	8	A,C,D	A,C,D	A,C,D	A,C,D	A,C,D	A,C,D	A,C,D	A,C,D	A,C,D	A,C,D	A,C,D	A,C,D	A,C,D	S	
Rockford	**	Yes	1,4	A,C,D	A,C,D	A,C,D	A,C,D	A,C,D	A,C,D	A,C,D	A,C,D	A,C,D	A,C,D	A,C,D	A,C,D	S	
Indiana	Yes	2,3,4	A,C,D	A,C,D	A,C,D	A,C,D	A,C,D	A,C,D	A,C,D	A,C,D	A,C,D	C,D	C,D	A,C,D	A,C,D	M,Q,R	B
Evansville	Yes	3,4	A,C,D	A,C,D	C,D	A,C,D	C,D	A,C,D	C,D	C,D	A,C,D			C,D	C,D	Q	B
Fort Wayne	Yes	1,3,4	A,C,D	A,C,D	A,C,D	A,C,D	A,C,D	A,C,D	A,C,D	A,C,D	A,C,D	A,C,D	B,C,D	A,C,D	A,C,D	M,Q	B
Gary	Yes	1,4	A,C,D	A,C,D	A,C,D	C,D	C,D	C,D	C,D	C,D	C,D	C,D	C,D	C,D	C,D	S	B
Indianapolis	**	Yes	2	A,C,D	A,C,D	C,D	A,C,D	C,D	C,D	C,D	A,C,D	A,C,D	A,C,D	A,C,D	A,C,D	S	
South Bend	Yes	1,3,4	A,C,D	A,C,D	A,C,D	A,C,D	A,C,D	C,D	A,C,D	C,D	A,C,D	A,C,D	C,D	A,C,D	A,C,D	M	B
Iowa	Yes	1,4	A,C,D	A,C,D	C,D	C,D	C,D	C,D	C,D	C,D	C,D	C,D	C,D	C,D	C,D	M,Q	B
Des Moines	Yes	3,4	A,C,D	A,C,D	C,D	C,D	C,D	C,D	C,D	C,D	C,D	C,D	C,D	C,D	C,D	M,Q	B
Kansas	Yes	1,3,4	A,C,D	A,C,D	C,D											M,O	B
Kansas City	**	Yes	3,4	A,C,D	A,C,D	C,D										S	B
Wichita	**	Yes	4	A,C,D	A,C,D	C,D										S	B
Kentucky	Yes	1,2,4,5	A,C,D	A,C,D	C,D	C,D	C,D	C,D	C,D	C,D				C,D	C,D	O,Q	B

NOTE: An explanation of the numbers and letters used is given at the end of the table.



TABLE 5.1 Codes for Emergency Power by States and Major Cities (Completed September 1984) (Continued)

State-City	Does State-City Have Legislation?	Legislation Code Type?	Hospitals	Nursing Homes	Schools	Theaters (Public Gathering Places)	Office Buildings	Hotels	Apartment Buildings	Airports	Fire and Police Stations	Water Treatment Plants	Sewage Treatment Plants	All Public Buildings, State	All Public Buildings, Commercial	Applicable Government Agency	Smokeproof Enclosures in High-Rise Buildings
Louisiana	Yes	1,4	A,C,D	A,C,D	C,D	C,D	C,D	C,D	C,D	C,D				C,D	C,D	M,Q	
Baton Rouge	** Yes	4	A,C,D	A,C,D	B,C,D	A,C,D	B,C,D	A,C	C	A,C,D	A,C,D	B	B	C,D	C,D	S	
New Orleans	** Yes	4	A,C,D	A,C,D	C,D	C,D	A,C,D*	A,C,D*	C	C,D	C,D			C,D	C,D	S	
Shreveport	Yes	1,4	A,C,D	A,C,D	B,C,D	C,D	A,C,D	C,D	C,D	A,C,D	A,C,D	C,D	C,D	C,D	A,C,D	S	
Maine	Yes	1,2,4	A,C,D	C,D	C,D	C,D	C,D	C,D	C,D	C,D						M,S	A
Maryland	Yes	1,2,4,5	A,C,D	A,C,D	C,D	C,D	C,D	C,D	C,D	A,C,D	C,D			C,D	C,D	M,N	A
Baltimore	** Yes	4,8	A,C,D	C,D	C,D	A,C,D	C,D	A,C,D	C,D	A,C,D	C,D	C,D	C,D	C,D	C,D	S	
Massachusetts	Yes	2,5	A,C,D	A,C,D	A,C,D	C,D	C,D	C,D	C,D	C,D	C,D	C,D	C,D	C,D	C,D	P,Q	B
Bedford	** Yes	2	A,C,D	C,D	C,D	C,D	C,D	C,D	C,D	C,D	C,D	C,D	C,D	C,D	C,D	S	
Boston	** Yes	2		A,C,D	A,C,D	A,C,D	A,C,D	A,C,D	A,C,D							S	
Cambridge	** Yes	2	A,B	A,C,D	A,C,D	A,C,D	A,C,D	A,C,D	A,C,D		A,C,D	A,C,D	A,C,D	A,C,D	A,C,D	S	
Springfield	** Yes	2	A,C,D	A,C,D	A,C,D	A,C,D	A,C,D	A,C,D	A,C,D		A,C,D			A,C,D	A,C,D	Q	
Worcester	** Yes	2	A,C	A,C	A,C	A,C		A,C	A,C	A,C	A,C					Q	
Michigan	Yes	2,4,5	A,C,D	A,C,D	A,C,D	A,C,D	C,D	A,C,D	C,D	A,C,D	C,D	B,C,D	B,C,D	C,D	C,D	R	B
Detroit	Yes	1,4,5	A,C,D	A,C,D	A,C,D	A,C,D	A,C,D	A,C,D	A,C,D	A,C,D	B,C,D	B,C,D	B,C,D		A,C,D	M,S	B
Flint	** Yes	4,5	A,C,D	A,C,D	A,C,D	A,C,D										M,S	
Grand Rapids	Yes	1,4,5	A,C,D	A,C,D	A,C,D	A,C,D	C,D	A,C,D	C,D	C,D	C,D			C,D	C,D	M,S	B
Lansing	** Yes	2	A,C,D	A,C,D	A,C,D	A,C,D	A,C,D	A,C,D	A,C,D			B	B	C,D	C,D	D	
Minnesota	Yes	2,3,4,7	A,C,D	A,C,D	A,C,D	A,C,D	A,C,D	A,C,D	A,C,D	A,C,D	C,D	C,D	C,D	C,D	C,D	M,N,O	B
Minneapolis	Yes	1,3,4	A,C,D	A,C,D	A,C,D	A,C,D	A,C,D	A,C,D	A,C,D	A,C,D	C,D	C,D	C,D	C,D	C,D	M,S	B
Saint Paul	Yes	1,3,4	A,C,D	A,C,D	C,D	C,D	A,C,D	A,C,D	C,D	C,D	A	A,C,D	A,C,D	A,C,D	A,C,D	M,S	B
Mississippi	Yes	1,4,6	A,C,D	C,D	A,C,D	A,C,D	A,C,D	A,C,D	C,D	C,D	C,D	C,D	C,D	C,D	C,D	M	
Jackson	Yes	1,4	A,C,D	C,D												S	
Missouri	No																
Kansas City	Yes	4	A,C,D														
Montana	Yes	2,3,4	A,C,D	A,C,D	C,D	C,D	C,D	C,D	C,D	C,D				C,D	C,D	M,Q	A
Nebraska	Yes	1,4	A,C,D	A,C,D	C,D	C,D	C,D	C,D	C,D	C,D				C,D	C,D	M	

NOTE: An explanation of the numbers and letters used is given at the end of the table.



TABLE 5.1 Codes for Emergency Power by States and Major Cities (Completed September 1984) (Continued)

State/City	Does State/City Have Legislation?	Legislation Code Type?	Hospitals	Nursing Homes	Schools	Theaters (Public Gathering Places)	Office Buildings	Hotels	Apartment Buildings	Airports	Fire and Police Stations	Water Treatment Plants	Sewage Treatment Plants	All Public Buildings, State	All Public Buildings, Commercial	Applicable Government Agency	Smokeproof Enclosures in High-Rise Buildings
Lincoln	Yes	4,8	A,C,D	A,C,D	C,D	C,D	C,D	C,D	C,D	C,D						M,S	
Omaha	Yes	4,8	A,C,D	A,C,D	C,D	C,D	C,D	C,D	C,D	C,D						S	
Nevada	Yes	1,2,3,4	A,C,D	A,C,D	C,D	C,D	C,D	C,D	C,D	C,D				A,C,D		M,O,Q	A*
New Hampshire	Yes	1,2,4	A,C,D	A,C,D	C,D	C,D	C,D	C,D	C,D	C,D						M	
New Jersey	Yes	2,3,4,5	A,C,D	A,C,D	C,D	C,D	C,D	C,D	C,D	C,D						Q	A
New Mexico	Yes	1,2,3,4	A,C,D	A,C,D	A,C,D	A,C,D	A,C,D	A,C,D	C,D	A,C,D	C,D	C,D	C,D	C,D	A,C,D	Q	
Albuquerque	Yes	3,4	A,C,D	A,C,D	C,D	C,D	C,D	C,D	C,D	C,D	C,D	C,D	C,D	C,D	C,D	S	
New York	Yes	2,4	A,C,D	A,C,D	C,D	C,D	C,D	C,D	C,D	C,D		B,C,D	B,C,D	C,D	C,D	O	A
Albany	Yes	2,4	A,C,D	A,C,D	C,D	C,D	C,D	C,D	C,D	C,D		B,C,D	B,C,D	C,D	C,D	Q	
Buffalo	Yes	2,8	A,C,D	A,C,D	C,D	C,D	C,D	C,D	C,D	C,D	C,D		B,C,D	B,C,D	C,D	C,D	N,O,R
New York	Yes	2,8	A,C,D	A,C,D	C,D	C,D	C,D	C,D	C,D	C,D						Q	
Syracuse	Yes	3,8	A,C,D	A,C,D	C,D	C,D	C,D	C,D	C,D	C,D						M,Q	B
North Carolina	Yes	2,4,6	A,C,D	A,C,D	C,D	C,D	C,D	C,D	C,D	C,D				C,D	C,D	O,T	A
North Dakota	Yes	1,3,4	A,C,D	A,C,D	C,D	C,D	C,D	C,D	C,D	C,D	C,D	C,D	C,D	C,D	C,D	M,O	
Ohio	Yes	2,4,5	A,C,D	A,C,D	C,D	C,D	C,D	C,D	C,D	C,D	C,D	C,D	C,D	C,D	C,D	Q,S	A
Akron	Yes	2,4,5	A,C,D	A,C,D	C,D	A,C,D	A,C,D	A,C,D	A,C,D	C,D	C,D	C,D	C,D	C,D	C,D	O	A
Cincinnati	Yes	2,4,5	A,C,D	A,C,D	C,D	A,C,D	A,C,D	A,C,D	A,C,D	C,D	C,D	C,D	C,D	C,D	C,D	Q,S	A
Cleveland	Yes	2,4,5	A,C,D	A,C,D	C,D	C,D	C,D	C,D	C,D	C,D	C,D	C,D	C,D	C,D	C,D	M,Q	A
Dayton	Yes	2,4	A,C,D	A,C,D	C,D	C,D	C,D	C,D	C,D	C,D	C,D	C,D	C,D	C,D	C,D	Q	A
Youngstown	Yes	2,4,5	A,C,D	A,C,D	C,D	C,D	C,D	C,D	C,D	C,D	C,D	C,D	C,D	C,D	C,D	Q	A
Oklahoma	Yes†	1,2	A,C,D	C,D	C,D	C,D	C,D	C,D	C,D	A,C,D	C,D	C,D	C,D	C,D	C,D	M	
Oregon	Yes	1,2,3,4	A,C,D	A,C,D	C,D	C,D	C,D	C,D	C,D	A,C,D	C,D	C,D	C,D	C,D	C,D	M,Q	B
Portland	**	Yes	1,2,4	A,C,D	C,D	C,D	C,D	A,C,D	A,C,D	C,D				A,C,D	C,D	M,Q	
Pennsylvania	Yes	1,2	A,C,D	A,C,D	A,C,D	A,C,D	A,C,D	A,C,D	A,C,D	A,C,D	A,C,D			A,C,D	A,C,D	R	A
Philadelphia	Yes	4,8	A,C,D	A,C,D	A,C,D	A,C,D	A,C,D	A,C,D	A,C,D	A,C,D	C,D	C,D	C,D	A,C,D	A,C,D	M,Q	A
Rhode Island	Yes	2,4,5	A,C,D	A,C,D	C,D	C,D	C,D	C,D	C,D	C,D	C,D	C,D	C,D	C,D	C,D	M,Q	A
South Carolina	Yes	1,4,6	A,C,D	A,C,D	C,D	C,D	C,D	C,D	C,D	C,D				C,D	C,D	M,O	

NOTE: An explanation of the numbers and letters used is given at the end of the table.



TABLE 5.1 Codes for Emergency Power by States and Major Cities (Completed September 1984) (Continued)

State/ City	Does State/ City Have Legislation?	Legislation Code Type?	Hospitals	Nursing Homes	Schools	Theaters (Public Gathering Places)	Office Buildings	Hotels	Apartment Buildings	Airports	Fire and Police Stations	Water Treatment Plants	Sewage Treatment Plants	All Public Buildings, State	All Public Buildings, Commercial	Applicable Government Agency	Smokeproof Enclosures in High-Rise Buildings
South Dakota	Yes	1,2,4	A,C,D	A,C,D	C,D	C,D		C,D		C,D				C,D	C,D	M	
Tennessee	Yes	1,4,6	A,C,D	A,C,D	C,D	C,D	C,D	C,D	C,D					C,D	C,D	M,N,O	A
Texas	Yes	2	A,C,D	B,C,D												M,O,U	
Amarillo	**	Yes	A,C	A,C	C,D	C,D	C,D	C,D	C	A,C	A,C	A	A	A	C	O	
Austin	Yes	3	A,C,D	A,C,D	C,D	C,D	C,D	C,D	C,D	C,D	C,D			C,D	C,D	Q	
Corpus Christi	**	Yes	3	A,C,D	A,C,D	C,D	A,C,D	C,D	C,D	A,C,D				C,D	C,D	S	
Dallas	**	Yes	3,4	A,C,D	A,C,D	C,D	A,C,D	A,C,D	A,C,D	C,D	C,D	C,D	C,D	C,D	C,D	S	A
El Paso	Yes	4,6	A,C,D	A,C,D	C,D	C,D	C,D	C,D	C,D					A,C,D	A,C,D	S	
Fort Worth	**	Yes	3,4	A,C,D	C,D	C,D	C,D	C,D	C,D	C,D	A,C,D	C,D	C,D	C,D	C,D	S	
Houston	Yes	3,4,8	A,C,D	A,C,D	C,D	C,D	B,C,D*	B,C,D*	B,C,D*	B,C,D*	B,C,D*	C,D	C,D	B,C,D*	B,C,D*	S	
Lubbock	Yes	1,3,4	A,C,D	A,C,D	C,D	C,D	C,D	C,D	C,D	C,D	C,D	C,D	C,D	C,D	C,D	M,Q	B
San Antonio	**	Yes	4,8	A,C,D	A,C,D	C,D	A,C,D	C,D	C,D	C,D	A,C,D	C,D	C,D	C,D	A,C,D	M	
Wichita Falls	**	Yes	7	A,C,D	A,C,D	C,D	C,D	C,D	C,D	C,D	C,D	C,D	C,D	C,D	C,D	S	
Utah	Yes	1,2,3,4	A,C,D	A,C,D	C,D	C,D	C,D	C,D	C,D	C,D	C,D	C,D	C,D	C,D	C,D	M,Q	B
Salt Lake City	**	Yes	3,8	C,D	C,D	C,D	C,D	C,D	C,D	C,D	C,D	C,D	C,D	C,D	C,D	M,Q	
Vermont	Yes	1,2,4,5	A,C,D	A,C,D	C,D	C,D	C,D	C,D	C,D	C,D	C,D			C,D	C,D	R	
Virginia	Yes	2,4,5	A,C,D	C,D	C,D	C,D	C,D	C,D	C,D	C,D	C,D	C,D	C,D	C,D	C,D	O	B
Richmond	Yes	1,4,5	A,C,D	A,C,D	C,D	C,D	C,D	C,D	C,D	C,D	C,D	C,D	C,D	C,D	C,D	O,Q	
Virginia Beach	Yes	4,5	A,C,D	A,C,D	A,C,D	A,C,D	C,D	C,D	C,D	A,C,D	B,C,D			C,D	C,D	Q	
Washington	Yes	2,3,4	A,C,D	A,C,D	C,D	C,D	C,D	C,D	C,D	C,D				C,D	C,D	R	B
Seattle	**	Yes	3,4	A,C,D	A,C,D	C,D	C,D	A,C,D	A,C,D	C,D	C,D	A,B	A,B	A,B	C,D	Q	
West Virginia	Yes	1,2,4	A,C,D	A,C,D	C,D	C,D	C,D	C,D	C,D	C,D	C,D	C,D	C,D	C,D	C,D	M,O	
Wisconsin	Yes	2,4	A,C,D	A,C,D	C,D	C,D	C,D	C,D	C,D	C,D	C,D	C,D	C,D	C,D	C,D	R,S	
Madison	Yes	2,4	A,C,D	A,C,D	C,D	C,D	C,D	C,D	C,D	C,D	C,D	C,D	C,D	C,D	C,D	O	
Milwaukee	Yes	2,4,8	A,C,D	A,C,D	C,D	C,D	C,D	C,D	C,D	C,D	C,D	C,D	C,D	C,D	C,D	Q	
Wyoming	Yes	1,2,3	A,C,D	A,C,D	A,C,D	C,D	C,D	C,D	C,D	C,D	C,D	C,D	C,D	C,D	C,D	M,N,P	

NOTE: An explanation of the numbers and letters used is given at the end of the table.

TABLE 5.1 Codes for Emergency Power by States and Major Cities (Completed September 1984) (*Continued*)Explanation of Numbers and Letters Used in Table 1:

Legislation Code Type

1. Life Safety Code, ANSI/NFPA 101-1985 [11]
2. State
3. Uniform Building Code [24]
4. National Electrical Code, ANSI/NFPA 70-1987 [9]
5. Building Officials and Code Administration (BOCA)
6. Standard Building Code [23]
7. Health Care Facilities Code, ANSI/NFPA 99-1984 [10]
8. City

Power Source

- A. Emergency Power
- B. Standby Power
- C. Exit Lighting
- D. Egress Lighting

Governing Agency

- M. Fire Marshal or Division of Fire
- N. Department of Public Health
- O. Local Government Units
- P. Public Safety
- Q. Building Commission or Department
- R. Department of Labor
- S. Inspection Department
- T. Department of Insurance
- U. Various, but usually depends on occupancy

*High-rise building.

**No changes made since previous report.

†State buildings only.

Table 1 courtesy of the Electrical Generating Systems Marketing Association (April 1975).

From IEEE Std. 446-1995. Copyright 1995 IEEE. All rights reserved.

Condensed General Need Criteria

Table 5.2 lists the needs in 13 general categories, with some breakdown under each, to indicate major requirements. Ranges under the columns “Maximum Tolerance Duration of Power Failure” and “Recommended Minimum Auxiliary Supply Time” are assigned based upon experience. Written standards have been referenced where applicable.

In some cases, under the columns “Type of Auxiliary Power System,” both emergency and standby have been indicated as required. An emergency supply of limited time capacity may be used at a low cost for immediate or interruptible power until a standby supply can be brought on-line. An example would be the case in which battery lighting units come on until a standby generator can be started and transferred to critical loads.

Readers using this text may find that various combinations of general needs will require an in-depth system and cost analysis that will modify the recommended equipment and systems to best meet all requirements.

Small commercial establishments and manufacturing plants will usually find their requirements under two or three of the general need guidelines given in this chapter. Large manufacturers and commercial facilities will find that portions or all of the need guidelines given here apply to their operations and justify or require emergency and backup standby electric power.

Typical Emergency/Standby Lighting Recommendations

For short time durations, primarily lighting for personnel safety and evacuation purposes, battery units are satisfactory. Where longer service and heavier loads are required, an engine or turbine-driven generator is usually used, which starts automatically upon failure of the prime power source with the load applied by an automatic transfer switch. It is generally considered that an average level of 0.4 footcandles (fc) is adequate in which passage is required and no precise operations are expected.

Table 5.3 summarizes the user’s needs for emergency and standby electric power for lighting by application and areas.

5.1 EMERGENCY/STANDBY POWER SOURCE OPTIONS

Power Sources

Sources of emergency power may include batteries, local generation, a separate source over separate lines from the electric utility, or various combinations of these. The quality of service required, the amount of load to be served, and the characteristics of the load will determine which type of emergency supply is required.

TABLE 5.2 Condensed General Criteria for Preliminary Consideration

General Need	Specific Need	Maximum Tolerance Duration of Power Failure	Recommended Minimum Auxiliary Supply Time	Type of Auxiliary Power System		System Justification
				Emergency	Standby	
Lighting	Evacuation of personnel	Up to 10 s, preferably not more than 3 s	2 h	×		Prevention of panic, injury, loss of life Compliance with building codes and local, state, and federal laws Lower insurance rates Prevention of property damage Lessening of losses due to legal suits
	Perimeter and security	10 s	10–12 h during all dark hours	×	×	Lower losses from theft and property damage Lower insurance rates Prevention of injury
	Warning	From 10 s up to 2 or 3 min	To return to prime power source	×		Prevention or reduction of property loss Compliance with building codes and local, state, and federal laws Prevention of injury and loss of life
	Restoration of normal power system	1 s to indefinite depending on available light	Until repairs completed and power restored	×	×	Risk of extended power and light outage due to a longer repair time
	General lighting	Indefinite; depends on analysis and evaluation	Indefinite; depends on analysis and evaluation		×	Prevention of loss of sales Reduction of production losses Lower risk of theft Lower insurance rates

TABLE 5.2 Condensed General Criteria for Preliminary Consideration (*Continued*)

General Need	Specific Need	Maximum Tolerance Duration of Power Failure	Recommended Minimum Auxiliary Supply Time	Type of Auxiliary Power System		System Justification
				Emergency	Standby	
	Hospitals and medical areas	Uninterruptible to 10 s ANSI/NFPA 99-1984 [10], 101-1985 [11] allow 10 s for alternate power source to start and transfer	To return of prime power	×	×	Facilitate continuous patient care by surgeons, medical doctors, nurses, and aids Compliance with all codes, standards, and laws Prevention of injury or loss of life Lessening of losses due to legal suits
	Orderly shutdown time	0.1 s to 1 h	10 min to several hours	×		Prevention of injury or loss of life Prevention of property loss by a more orderly and rapid shutdown of critical systems Lower risk of theft Lower insurance rates
Startup power	Boilers	3 s	To return of prime power	×	×	Return to production Prevention of property damage due to freezing Provision of required electric power
	Air compressors	1 min	To return of prime power		×	Return to production Provision for instrument control
Transportation	Elevators	15 s to 1 min	1 h to return of prime power		×	Personnel safety Building evacuation Continuation of normal activity
	Material handling	15 s to 1 min	1 h to return of prime power		×	Completion of production run Orderly shutdown Continuation of normal activity
	Escalators	15 s to no requirement for power	Zero to return of prime power		×	Orderly evacuation Continuation of normal activity

TABLE 5.2 Condensed General Criteria for Preliminary Consideration (*Continued*)

General Need	Specific Need	Maximum Tolerance Duration of Power Failure	Recommended Minimum Auxiliary Supply Time	Type of Auxiliary Power System		System Justification
				Emergency	Standby	
Mechanical utility systems	Conveyors	15 s to 1 min	As analyzed and economically justified		×	Completion of production run Completion of customer order Orderly shutdown Continuation of normal activity
	Water (cooling and general use)	15 s	½ h to return of prime power		×	Continuation of production Prevention of damage to equipment Supply of fire protection
	Water (drinking and sanitary)	1 min to no requirement	Indefinite until evaluated		×	Providing of customer service Maintaining personnel performance
	Boiler power	0.1 s	1 h to return of prime power	×	×	Prevention of loss of electric generation and steam Maintaining production Prevention of damage to equipment
	Pumps for water, sanitation, and production fluids	10 s to no requirement	Indefinite until evaluated		×	Prevention of flooding Maintaining cooling facilities Providing sanitary needs Continuation of production Maintaining boiler operation
Heating	Fans and blowers for ventilation and heating	0.1 s to return of normal power	Indefinite until evaluated	×	×	Maintaining boiler operation Providing for gas-fired unit venting and purging Maintaining cooling and heating functions for buildings and production
	Food preparation	5 min	To return of prime power		×	Prevention of loss of sales and profit Prevention of spoilage of in-process preparation

TABLE 5.2 Condensed General Criteria for Preliminary Consideration (*Continued*)

General Need	Specific Need	Maximum Tolerance Duration of Power Failure	Recommended Minimum Auxiliary Supply Time	Type of Auxiliary Power System		System Justification
				Emergency	Standby	
Refrigeration	Process	5 min	Indefinite until evaluated; normally for time for orderly shut-down, or to return of prime power		×	Prevention of in-process product damage Prevention of property damage Continued production Prevention of payment to workers during no production Lower insurance rates
	Special equipment or devices which have critical warmup (cryogenics)	5 min	To return of prime power		×	Prevention of equipment or product damage
	Depositories of critical nature (blood banks, etc)	5 min (10 s per ANSI/NFPA 99-1984 [10])	To return of prime power		×	Prevention of loss of material stored
	Depositories of noncritical nature (meat, produce, etc)	2 h	Indefinite until evaluated		×	Prevention of loss of material stored Lower insurance rates
Production	Critical process power (sugar factory, steel mills, chemical processes, glass products, etc)	1 min	To return of prime power or until orderly shut-down		×	Prevention of product and equipment damage Continued normal production Reduction of payment to workers on guaranteed wages during nonproductive period Lower insurance rates Prevention of prolonged shut-down due to nonorderly shut-down

TABLE 5.2 Condensed General Criteria for Preliminary Consideration (*Continued*)

General Need	Specific Need	Maximum Tolerance Duration of Power Failure	Recommended Minimum Auxiliary Supply Time	Type of Auxiliary Power System		System Justification
				Emergency	Standby	
	Process control power	Uninterruptible (UPS) to 1 min	To return of prime power	×	×	Prevention of loss of machine and process computer control program Maintaining production Prevention of safety hazards from developing Prevention of out-of-tolerance products
Space conditioning	Temperature (critical application)	10 s	1 min to return of prime power	×	×	Prevention of personnel hazards Prevention of product or property damage Lower insurance rates Continuation of normal activities Prevention of loss of computer function
	Pressure (critical pos/neg atmosphere)	1 min	1 min to return of prime power	×	×	Prevention of personnel hazards Continuation of normal activities Prevention of product or property damage Lower insurance rates Compliance with local, state, and federal codes, standards, and laws
	Humidity (critical)	1 min	To return of prime power		×	Prevention of loss of computer functions Maintenance of normal operations and tests Prevention of explosions or other hazards

TABLE 5.2 Condensed General Criteria for Preliminary Consideration (*Continued*)

General Need	Specified Need	Maximum Tolerance Duration of Power Failure	Recommended Minimum Auxiliary Supply Time	Type of Auxiliary Power System		System Justification
				Emergency	Standby	
	Static charge	10 s or less	To return of prime power	×	×	Prevention of static electric charge and associated hazards Continuation of normal production (printing press operation, painting spray operations)
	Building heating and cooling	30 min	To return of prime power		×	Prevention of loss due to freezing Maintenance of personnel efficiency Continuation of normal activities
	Ventilation (toxic fumes)	15 s	To return of prime power or orderly shutdown	×	×	Reduction of health hazards Compliance with local, state, and federal codes, standards, and laws Reduction of pollution
	Ventilation (explosive atmosphere)	10 s	To return of prime power or orderly shutdown	×	×	Reduction of explosion hazard Prevention of property damage Lower insurance rates Compliance with local, state, and federal codes, standards, and laws Lower hazard of fire Reduce hazards to personnel
	Ventilation (building general)	1 min	To return of prime power		×	Maintaining of personnel efficiency Providing make-up air in building

TABLE 5.2 Condensed General Criteria for Preliminary Consideration (*Continued*)

General Need	Specified Need	Maximum Tolerance Duration of Power Failure	Recommended Minimum Auxiliary Supply Time	Type of Auxiliary Power System		System Justification
				Emergency	Standby	
	Ventilation (special equipment)	15 s	To return of prime power or orderly shutdown	×	×	Purging operation to provide safe shutdown or startup Lowering of hazards to personnel and property Meeting requirements of insurance company Compliance with local, state, and federal codes, standards, and laws Continuation of normal operation
	Ventilation (all categories non-critical)	1 min	Optional		×	Maintaining comfort Preventing loss of tests
	Air pollution control	1 min	Indefinite until evaluated; compliance or shutdowns are options	×	×	Continuation of normal operation Compliance with local, state, and federal codes, standards, and laws
Fire protection	Annunciator alarms	1 s	To return of prime power	×		Compliance with local, state, and federal codes, standards, and laws Lower insurance rates Minimizing life and property damage
	Fire pumps	10 s	To return of prime power		×	Compliance with local, state, and federal codes, standards, and laws Lower insurance rates Minimizing life and property damage

TABLE 5.2 Condensed General Criteria for Preliminary Consideration (*Continued*)

General Need	Specified Need	Maximum Tolerance Duration of Power Failure	Recommended Minimum Auxiliary Supply Time	Type of Auxiliary Power System		System Justification
				Emergency	Standby	
	Auxiliary lighting	10 s	5 min to return of prime power	×	×	Servicing of fire pump engine should it fail to start Providing visual guidance for fire-fighting personnel
Data processing	CPU memory tape/disk storage, peripherals	½ cycle	To return of prime power or orderly shutdown	×	×	Prevention of program loss Maintaining normal operations for payroll, process control, machine control, warehousing, reservations, etc
	Humidity and temperature control	5 to 15 min (1 min for water-cooled equipment)	To return of prime power or orderly shutdown		×	Maintenance of conditions to prevent malfunctions in data processing system Prevention of damage to equipment Continuation of normal activity
Life support and life safety systems (medical field, hospitals, clinics, etc)	X-ray	Milliseconds to several hours	From no requirement to return of prime power, as evaluated	×	×	Maintenance of exposure quality Availability for emergencies
	Light	Milliseconds to several hours	To return of prime power	×	×	Compliance with local, state, and federal codes, standards, and laws Preventing interruption to operation and operating needs
	Critical to life, machines, and services	½ cycle to 10 s	To return of prime power	×	×	Maintenance of life Prevention of interruption of treatment or surgery Continuation of normal activity Compliance with local, state, and federal codes, standards, and laws

TABLE 5.2 Condensed General Criteria for Preliminary Consideration (*Continued*)

General Need	Specified Need	Maximum Tolerance Duration of Power Failure	Recommended Minimum Auxiliary Supply Time	Type of Auxiliary Power System		System Justification
				Emergency	Standby	
Communication systems	Refrigeration	5 min	To return of prime power		×	Maintaining blood, plasma, and related stored material at recommended temperature and in prime condition
	Teletypewriter	5 min	To return of prime power		×	Maintenance of customer services Maintenance of production control and warehousing Continuation of normal communication to prevent economic loss
	Inner building telephone	10 s	To return of prime power	×		Continuation of normal activity and control
	Television (closed circuit and commercial)	10 s	To return of prime power		×	Continuation of sales Meeting of contracts Maintenance of security Continuation of production
	Radio systems	10 s	To return of prime power	×	×	Maintenance of security and fire alarms Providing evacuation instructions Continuation of service to customers Prevention of economic loss Directing vehicles normally
	Intercommunication systems	10 s	To return of prime power	×	×	Providing evacuation instructions Directing activities during emergency Providing for continuation of normal activities Maintaining security

TABLE 5.2 Condensed General Criteria for Preliminary Consideration (*Continued*)

General Need	Specific Need	Maximum Tolerance Duration of Power Failure	Recommended Minimum Auxiliary Supply Time	Type of Auxiliary Power System		System Justification
				Emergency	Standby	
	Paging systems	10 s	½ h	×	×	Locating of responsible persons concerned with power outage Providing evacuation instructions Prevention of panic
Signal circuits	Alarms and announcement	1 to 10 s	To return of prime power	×	×	Prevention of loss from theft, arson, or riot Maintaining security systems Compliance with codes, standards, and laws Lower insurance rates Alarm for critical out-of-tolerance temperature, pressure, water level, and other hazardous or dangerous conditions Prevention of economic loss
	Land-based aircraft, railroad, and ship warning systems	1 s to 1 min	To return of prime power	×	×	Compliance with local, state, and federal codes, standards, and laws Prevention of personnel injury Prevention of property and economic loss

From IEEE Std. 446-1995. Copyright 1995 IEEE. All rights reserved.

TABLE 5.3 Typical Emergency and Standby Lighting Recommendations

Standby*	Immediate, Short-Term†	Immediate, Long-Term‡
Security lighting	Evacuation lighting	Hazardous areas
Outdoor perimeters	Exit signs	Laboratories
Closed circuit TV	Exit lights	Warning lights
Night lights	Stairwells	Storage areas
Guard stations	Open areas	Process areas
Entrance gates	Tunnels	
	Halls	Warning lights
Production lighting		Beacons
Machine areas	Miscellaneous	Hazardous areas
Raw materials storage	Standby generator areas	Traffic signals
Packaging	Hazardous machines	
Inspection		Health care facilities
Warehousing		Operating rooms
Offices		Delivery rooms
		Intensive care areas
Commercial lighting		Emergency treatment areas
Displays		
Product shelves		Miscellaneous
Sales counters		Switchgear rooms
Offices		Elevators
		Boiler rooms
Miscellaneous		Control rooms
Switchgear rooms		
Landscape lighting		
Boiler rooms		
Computer rooms		

* An example of a standby lighting system is an engine-driven generator.

† An example of an immediate short-term lighting system is the common unit battery equipment.

‡ An example of an immediate long-term lighting system is a central battery bank rated to handle the required lighting load only until a standby engine-driven generator is placed on-line.

Batteries

Batteries are the fundamental and most commonly used standby power source. They are typically in the form of unitized equipment (wall-packs) consisting of a rechargeable storage battery, automatic charger, floodlight-type lamps, and automatic transfer relay. They sometimes have remote lighting heads and usually have exit lights connected to them. Operation is typically at 12 VDC. These constitute decentralized systems.

There are also centralized systems that power remote lighting heads and exit lights that typically operate at 24 or 32 VDC. A variation of this is centralized inverter systems, which operate regular light fixtures and exit lights on their normal AC voltage of 120 or 277 VAC. Another variation is decentralized, self-contained, emergency lighting inverter units.

Batteries are also used as a backup power source for communications, security systems, telephone, and fire alarm systems.

Batteries provide a low first-cost option as an emergency source, but have a relatively high maintenance cost. They also have limited capacity, thereby restricting the equipment loads that they are suitable for supplying; their low-voltage operation presents voltage drop limitations.

Local Generation

Local generation is advisable when service is absolutely essential for lighting or power loads, or both, and when these loads are relatively large and are distributed over large areas. Several choices are available in the type of prime mover, voltage of the generator, and method of connection to the system. Various alternates should be considered. The prime mover supply may be steam, natural gas, gasoline, diesel fuel, or liquefied petroleum gas (LPG).

For generators over 500 kW, gas turbine-driven units may be a favorable choice. This type of unit has acceptable efficiency at full load but is much less efficient than other types of drives at partial load. Gas turbine-driven units do not start as rapidly as other drives, but they are reliable and require a minimum of attention. They generally will not meet NEC requirements for emergency systems. Generator sets requiring more than 10 s to develop power require that an auxiliary system supply power until the generator can pick up the load. Of all the prime mover supply choices, diesel fuel is probably the most widely used for commercial and institutional applications.

Fuel storage requirements should be determined after considering the frequency and duration of power outages, the types of emergency loads to be served, and the ease of replenishing fuel supplies. Some installations may require a supply sufficient for 3 months be maintained, whereas a 1-day supply may be adequate for others. Code requirements [see ANSI/NFPA 37-1990 (“Stationary Combustion Engines and Gas Turbines”)] severely limit the amount of fuel that can be stored in buildings, so that fuel may have to be piped to a small local (day) tank adjacent to the generator. The NEC and other codes [e.g., EGSA 109C-1984 (“Codes for Emergency Power by States and Major Cities”)] require an on-site fuel supply capable of operating the prime mover at full-demand load for at least 2 h.

A significant additional consideration germane to the fuel source is its emissions. The federal and state Environmental Protection Agencies have strict and complicated regulations for which compliance is mandatory. It is generally advisable to engage the services of an environmental consultant to ensure compliance with these laws and regulations. What it means to the electrical design professional is determining the total hours of operation for the engine-driven generator on an annual basis, including time for emergency operation, exercise, peak-shaving or load-shedding, parallel operation with the electric utility, and so on. The

emissions resulting from the hours of operation are taken in concert with any other source of emissions from the site, such as boilers, for total site emissions as a source. It is customary to estimate the hours of operation using your best judgment with a conservative margin of safety. There is close monitoring and stiff penalties for noncompliance.

Generator selection can only be made after a careful study of the system to which it is connected and the loads to be carried by it. The voltage, frequency, and phase relationships of the generator should be the same as in the normal system. The size of the generator will be determined by the load to be carried, with consideration given to the size of the individual motors to be started. Another consideration is the distortion created by the loads that the system will be supplying. The speed and voltage regulation required will determine the accuracy and sensitivity of regulating devices. When a generator is required to carry emergency loads only during power outages and should not operate in parallel with the normal system, the simplest type of regulating equipment is usually adequate. For parallel operation, good-quality voltage regulators and governors are needed to ensure proper and active and reactive power loading of the generator. When the generator is small in relation to the system, it is usually preferable to have a large drooping characteristic in the governor and considerable compensation in the voltage regulator so that the local generator will follow the larger system rather than try to regulate it. Automatic synchronizing packages for paralleling generators are available that may include all the protective features required for paralleling generators. The design of this equipment should be coordinated with the characteristics of the generator.

Multiple Service Connections

When the local utility company can provide two or more service connections over separate lines from separate generation points so that system disturbances or storms are not apt to affect both supplies simultaneously, local generation or batteries may not be justified. A second line for emergency power should not be relied upon, however, unless total loss of power can be tolerated on rare occasions. The alternate feeder can either serve as a standby with primary switching or have its own transformer with secondary switching.

Often, an alternate primary service feeder can be run physically separate from the normal service feeder but is not from a separate generation source. Because of this, it is common for critical load facilities such as hospitals and data centers to have multiple service connections in combination with local generation to ensure reliability and, thus, service continuity.

5.2 TYPICAL EMERGENCY/STANDBY SYSTEM ARRANGEMENTS

Some arrangements commonly found for multiple utility services and/or engine-driven local generation are as follows:

Multiple Utility Services

Multiple utility services may be used as an emergency or standby source of power. Required is an additional utility service from a separate source and the required switching equipment. Figure 5.1 shows automatic transfer between two low-voltage utility supplies. Utility source 1 is the normal power line and utility source 2 is a separate utility supply providing emergency power. Both circuit breakers are normally closed. The load must be able to tolerate the few cycles of interruption while the automatic transfer device operates.

Automatic switching equipment may consist of three circuit breakers with suitable control and interlocks, as shown in Figure 5.2. Circuit breakers are generally used for primary switching in which the voltage exceeds 600 V. They are more expensive but safer to operate, and the use of fuses for overcurrent protection is avoided.

Relaying is provided to transfer the load automatically to either source if the other one fails, provided that circuit is energized. The supplying utility will normally designate which source is for normal use and which is for emergency. If either supply is not able to carry the entire load, provisions must be made to drop noncritical loads before the

FIGURE 5.1 Two-utility source system using one automatic transfer switch. (From IEEE Std. 446-1995. Copyright 1995 IEEE. All rights reserved.)

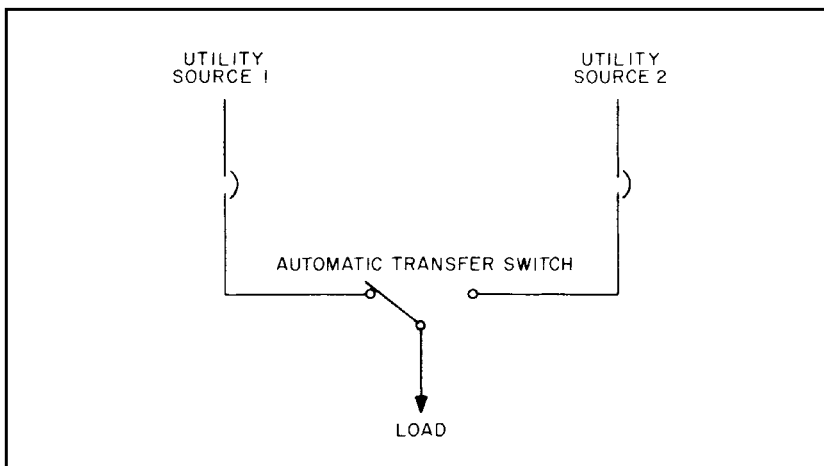
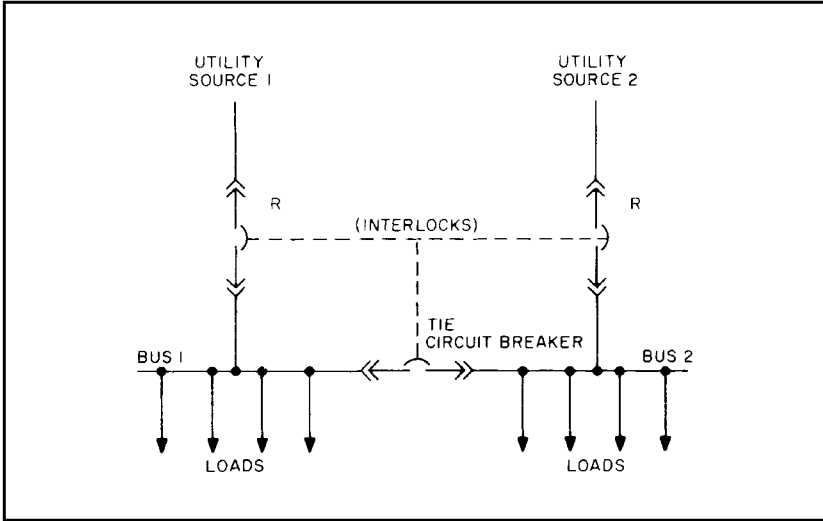

FIGURE 5.2 Two-utility source system in which any two circuit breakers can be closed. (From IEEE Std. 446-1995. Copyright 1995. All rights reserved.)



transfer takes place. If the load can be taken from both services, the two R circuit breakers are closed and the tie circuit breaker is open. This mode of operation is generally preferred by the supplying utility and the customer. The three circuit breakers are interlocked to permit any two to be closed but prevent all three from being closed. The advantages of this arrangement are that the momentary transfer outage will occur only on the load supplied from the circuit that is lost, the loads can be balanced between the two buses, and the supplying utility doesn't have to keep track of reserve capacity for the emergency feeder. However, the supplying utility may not allow the load to be taken from both sources, especially because a more expensive totalizing meter may be required. A manual override of the interlock system should be provided so that a closed transition transfer can be made if the supplying utility wants to take either line out of service for maintenance or repair and a momentary tie is permitted.

If the supplying utility will not permit power to be taken from both sources, the control system must be arranged so that the circuit breaker on the normal source is closed, the tie circuit breaker is closed, and the emergency-source circuit breaker is open. If the utility will not permit dual or totalized metering, the two sources must be connected together to provide a common metering point and then connected to the distribution switchboard. In this case, the tie circuit breaker can be eliminated and the two circuit breakers act as a transfer device (sometimes

called a transfer pair). Under these conditions, the cost of an extra circuit breaker can rarely be justified.

The arrangement shown in Figure 5.2 only provides protection against failure of the normal utility service. Continuity of power to critical loads can also be disrupted by

1. An open circuit within the building (load side of the incoming service)
2. An overload or fault tripping out a circuit
3. An electrical or mechanical failure of the electric power distribution system within the building

It may be desirable to locate transfer devices close to the load and have the operation of the transfer devices independent of overcurrent protection. Multiple transfer devices of lower current rating, each supplying a part of the load, may be used rather than one transfer device for the entire load.

The arrangement shown in Figure 5.2 can represent the secondary of a double-ended substation configuration or a primary service. It is sometimes referred to as a “main-tie-main” configuration.

Availability of multiple utility service systems can be improved by adding a standby engine-generator set capable of supplying the more critical load. Such an arrangement, using multiple automatic transfer switches, is shown in Figure 5.3.

Transfer Methods

Figure 5.4, panel *a*, shows a typical switching arrangement in which a local emergency generator is used to supply the entire load upon loss of the normal power supply. All emergency loads are normally supplied through device A. Device B is open and the generator is at rest. When the normal supply fails, the transfer switch undervoltage relay is de-energized and, after a predetermined time delay, closes its engine-starting contacts. The time delay is introduced so that the generator will not be started unnecessarily during transient voltage dips and momentary outages. When the alternate source is a generator, sufficient time or speed monitoring should be allowed to permit the generator to reach acceptable speed (thus frequency and voltage) before transfer and application of load. It should be noted that the arrangement shown in Figure 5.4 (*a*) does not provide complete protection against power disruption within the building.

Panel *b* of Figure 5.4 shows a typical switching arrangement in which only the critical loads are transferred to the emergency source—in this case, an emergency generator. For maximum protection, the transfer switch is located close to the critical loads.

FIGURE 5.3 Diagram illustrating multiple automatic double-throw transfer switches providing varying degrees of emergency and standby power. (From IEEE Std. 241-1990. Copyright 1990 IEEE. All rights reserved.)

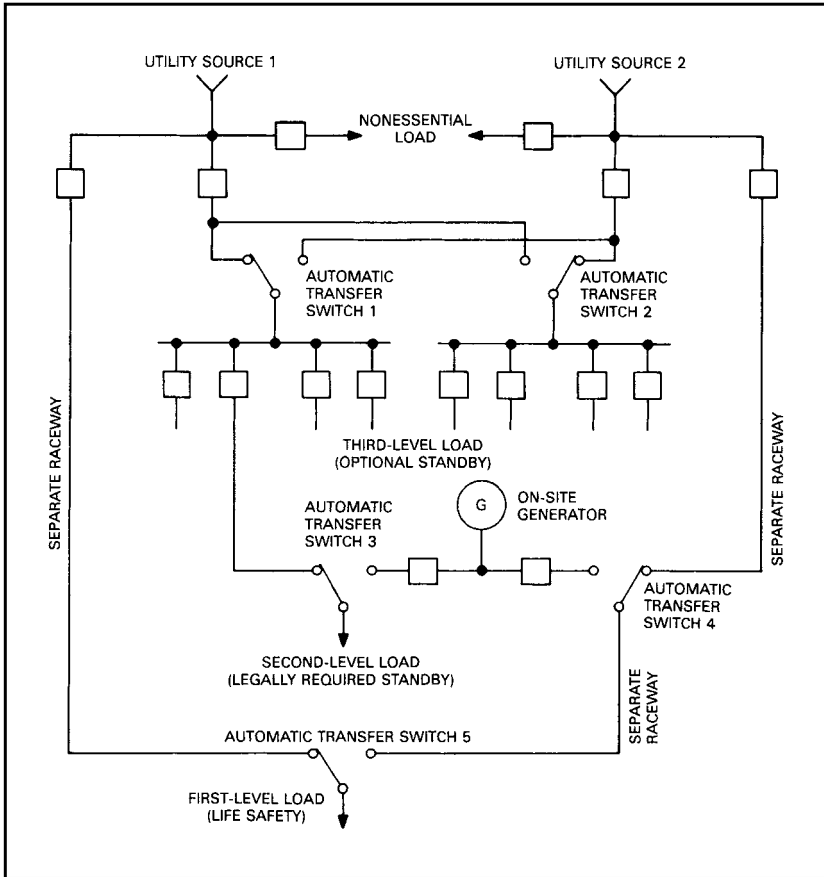

Other transfer methods are illustrated in the foregoing discussion of multiple utility services.

Parallel Generation

Enhanced reliability can be provided in large measure through redundancy, and engine-driven emergency generators are no exception. If, for example, a single 300-kW generator can accommodate all of the critical emergency load of a building and it is the only generator, should it fail to start for any reason or be out of service for routine maintenance at the time it is needed, you have no emergency service. To preclude this situation, good practice dictates that you have two generators, each

FIGURE 5.4 Typical transfer-switching methods. (a) Total transfer. (b) Critical load transfer. (From IEEE Std. 241-1990. Copyright 1990 IEEE. All rights reserved.)

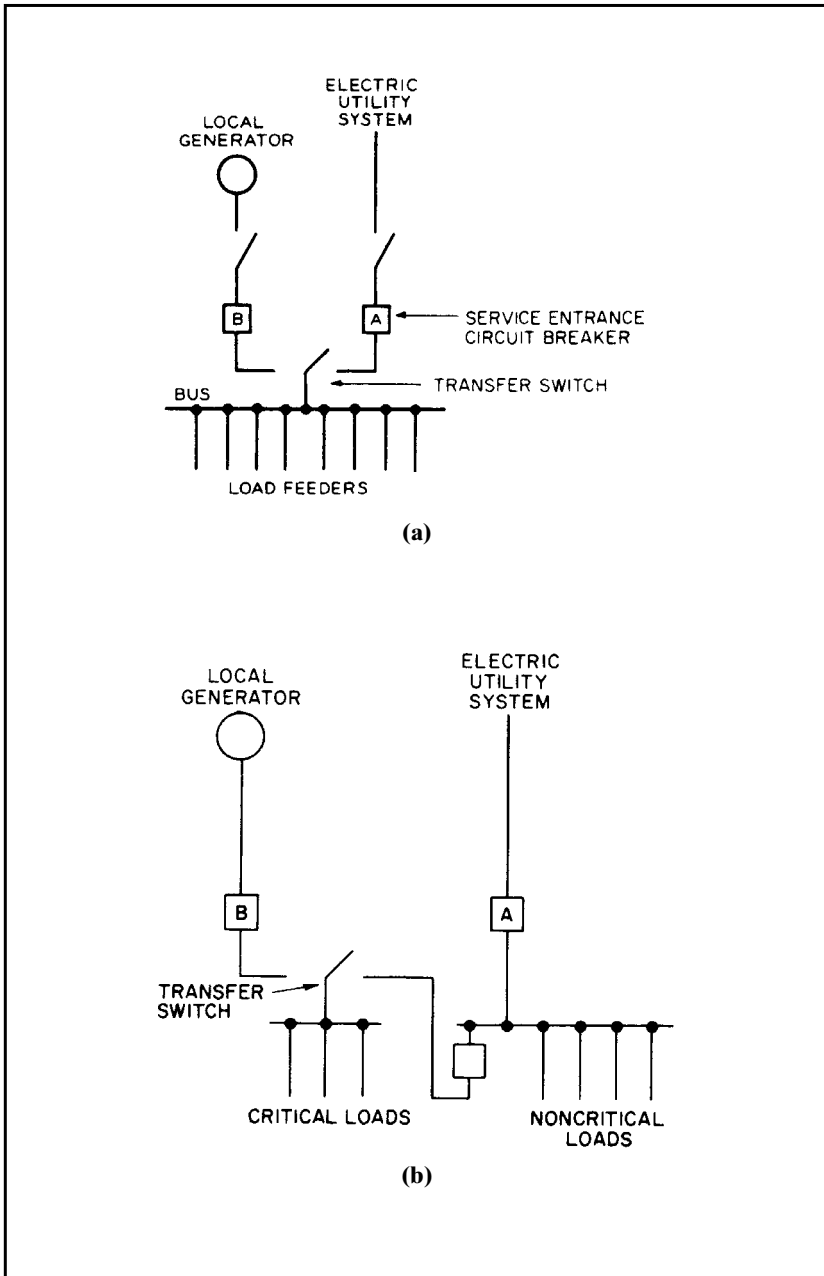

sized to accommodate the entire load and automatically synchronized, thus ensuring that at least one generator is available at all times. This concept can be extended to any situation (i.e., any two out of three units, three out of four, and so on). A good general philosophy is multiple small, rather than singular large, generating units.

To illustrate the operation of a typical multiengine automatic paralleling system and its sequence of operation, Figure 5.5 shows four engine generators that comprise an emergency source.

The operation is for a random-access paralleling system, and the loads are connected to the bus in random order, as they become available.

The loads, however, are always connected to the emergency bus in ascending order of priority beginning with priority one. For load shedding, the loads are disconnected in descending order of priority beginning with the last priority of load to be connected.

Upon a loss of normal-source voltage as determined by any one or more of the automatic transfer switches shown, a signal initiates starting of all engine-generator sets. The first set to come up to 90 percent of nominal voltage and frequency is connected to the alternate source bus. Critical and life safety loads are then transferred via ATS No. 1 and No. 2 to the bus upon sensing availability of power on the bus. As the remaining engine-generator sets achieve 90 percent of the nominal voltage and frequency, their respective synchronizing monitors will control the voltage and frequency of these oncoming units to produce synchronism with the bus. Once the oncoming unit is matched in voltage, frequency, and the phase angle with the bus, its synchronizer will initiate paralleling. Upon connection to the bus, the governor will cause the engine-generator set to share the connected load with the other on-line sets.

Each time an additional set is added to the emergency bus, the next load is transferred in a numbered sequence via additional transfer switches, such as ATS No. 3, until all sets and essential loads are connected to the bus. Control circuitry should prevent the automatic transfer or connection of loads to the bus until there is sufficient capacity to carry these loads. Provision is made for manual override of the load addition circuits for supervised operation.

Upon the restoration of the normal source of supply as determined by the automatic transfer switches, the engines are run for a period of up to 15 min for cooling down and then for shutdown. All controls automatically reset in readiness for the next automatic operation.

The system is designed so that reduced operation is automatically initiated upon failure of any plant through load dumping. This mode overrides any previous manual controls to prevent overloading the emergency bus. Upon sensing a failure mode on an engine, the controls automatically initiate disconnect, shutdown, and lockout of the failed engine, and reduction of the connected load to within the capacity of

FIGURE 5.5 Typical multiengine automatic paralleling system. (From IEEE Std. 602-1996. Copyright 1996. All rights reserved.)

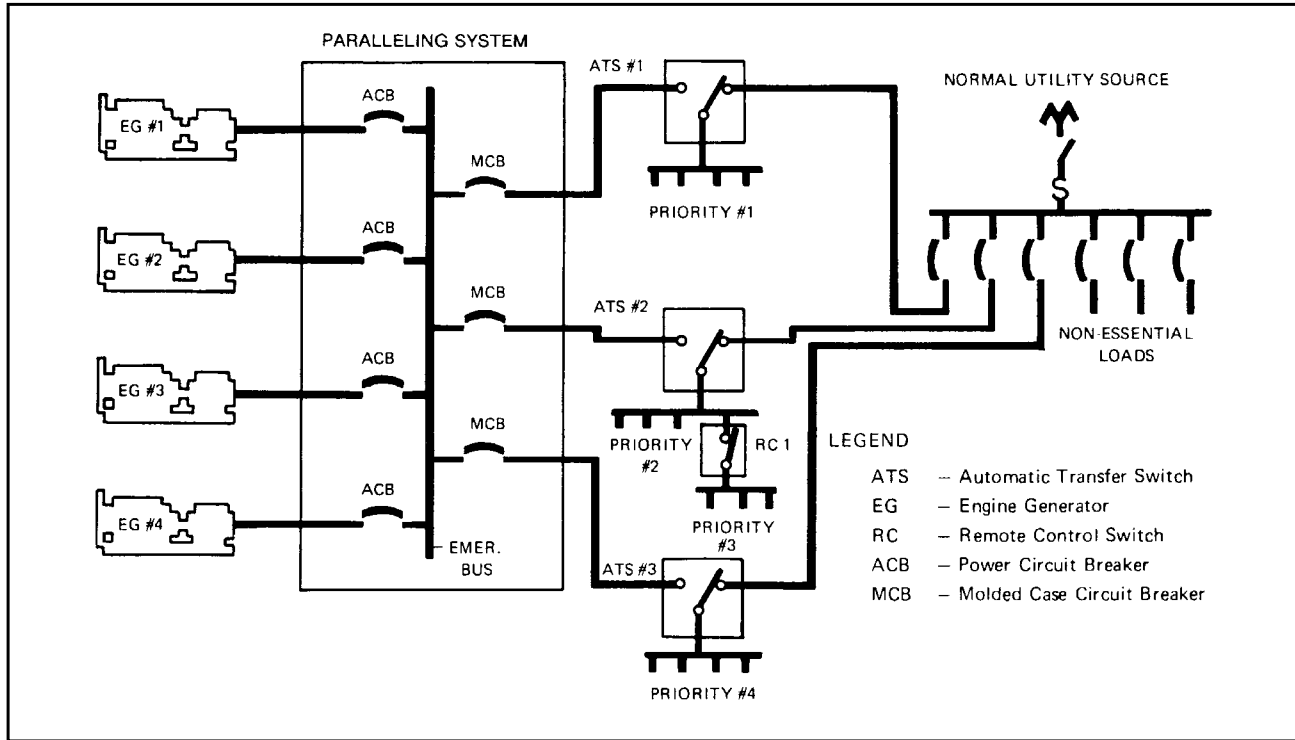

369

the remaining plants. Controls should require manual reset under these conditions.

Protection of the engine and generator against motorization is provided. A reverse-power monitor, upon sensing a motorizing condition on any plant, will initiate load shedding, disconnect the failing plant, and shut it down.

Sometimes a higher level of reliability is economically justifiable in a parallel generation arrangement for critical loads such as hospitals and data centers. This is known as providing an $(N + 1)$ level of reliability (redundancy) (i.e., providing one more generator than is needed to serve the emergency load). Thus, if one of the emergency generators fails to start or is out of service for any reason, the remaining plants can serve the entire emergency load. This precludes the need for automatic load shedding, which can be expensive in itself. Thus, this provides for two levels of contingency operation, the first being loss of the normal source of power, and the second being loss of one of the emergency/standby generators. Providing an even higher level of reliability is rarely justifiable.

Elevator Emergency Power Transfer System

Elevators present a unique emergency power situation. Where elevator service is critical for personnel and patients, it is desirable to have automatic power transfer with manual supervision. Operators and maintenance personnel may not be available in time if the power failure occurs on a weekend or at night.

1. *Typical elevator system:* Figure 5.6 shows an elevator emergency power transfer system whereby one preferred elevator is fed from a vital load bus through an emergency riser, while the rest of the elevators are fed from the normal service. By providing an automatic transfer switch for each elevator and a remote selector station, it is possible to select individual elevators, thus permitting complete evacuation in the event of power failure. The engine-generator set and emergency riser need only be sized for one elevator, thus minimizing the installation cost. The controls for the remote selector, automatic transfer switches, and engine starting are independent of the elevator controls, thereby simplifying installation.
2. *Regenerated power:* Regenerated power is a concern for motor-generator-type elevator applications. In some elevator applications, the motor is used as a brake when the elevator is descending and generates electricity. Electric power is then pumped back into the power source. If the source is commercial utility power, it can easily be absorbed. If the power source is an engine-driven generator, the regenerated power can cause the generating set and the

elevator to overspeed. To prevent overspeeding of the elevator, the maximum amount of power that can be pumped back into the generating set must be known. The permissible amount of absorption is approximately 20 percent of the generating set's rating in kilowatts. If the amount pumped back is greater than 20 percent, other loads must be connected to the generating set, such as emergency lights or "dummy" (parasitic) load resistances. Emergency lighting should be permanently connected to the generating set for maximum safety. A dummy (parasitic) load can also be automatically switched on the line whenever the elevator is operating from an engine-driven generator.

FIGURE 5.6 Elevator emergency power transfer system. (From IEEE Std. 302-1996. Copyright 1996 IEEE. All rights reserved.)

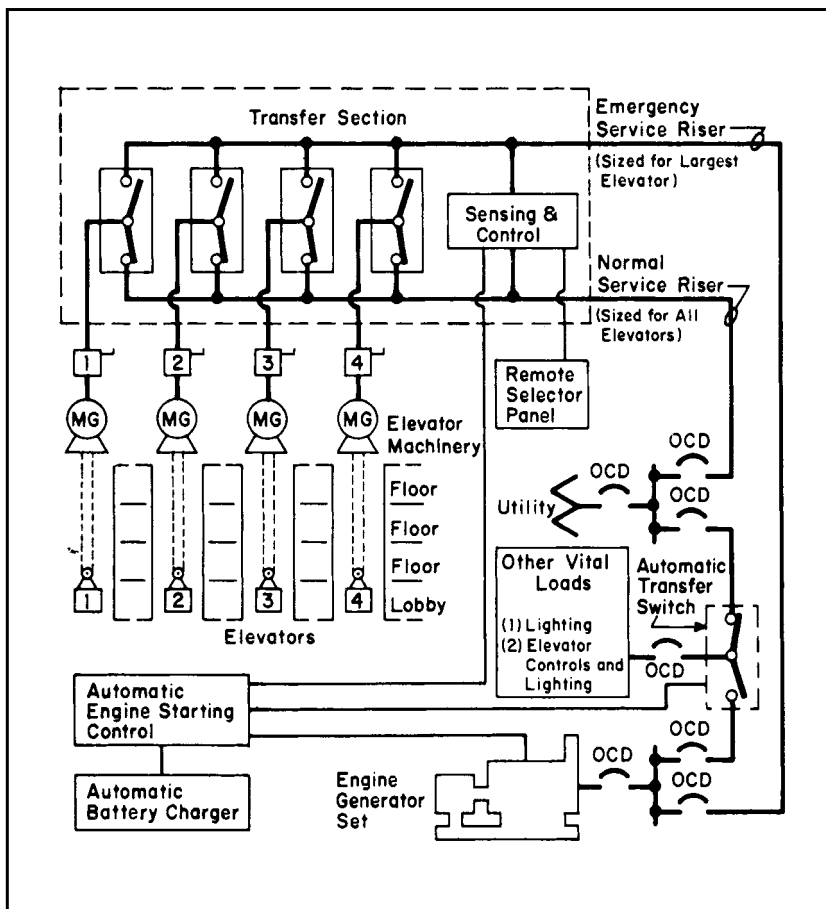

Hospitals/Health Care Facilities

Hospital/health care facilities present a unique situation. ANSI/NFPA 99-1984 mandates that emergency loads be broken into three distinct branches, namely critical, life safety, and equipment. This concept is illustrated in Figure 5.7.

This arrangement provides a very high level of reliability and integrity. Critical, life safety, and essential equipment loads are transferred automatically and immediately (i.e., with no intentional delay), to the emergency source upon loss of commercial power. Lower-priority nonessential loads are transferred manually via nonautomatic transfer switches when the system has stabilized in the emergency mode and available capacity has been verified.

FIGURE 5.7 Typical hospital installation with a nonautomatic transfer switch and several automatic transfer switches. (From IEEE Std. 446-1995. Copyright 1995 IEEE. All rights reserved.)

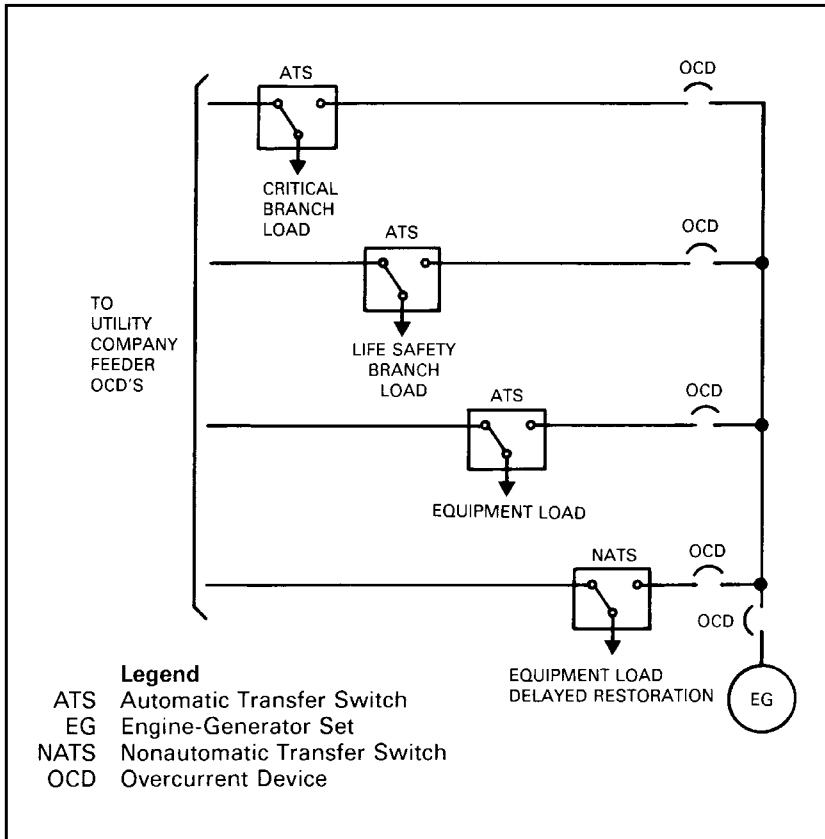

5.3 GENERATOR AND GENERATOR SET SIZING

Introduction

Proper sizing of a generator is an important task. The following guidelines represent the general and specific considerations that must be taken into account in properly sizing a generator for a specific application. These guidelines are based on Caterpillar Generator Sets as an industry leader. A common practice in the industry is to base a given design around a specific manufacturer of a major piece of equipment, such as a generator, and to make allowances for idiosyncratic differences that allow competitive bids and supply to the purchaser. Most generator manufacturers now use computer software programs for proper sizing of generators in specific applications. The following is provided to give a basic understanding of the methodology and can be used for preliminary calculations. It is in this context that the Caterpillar guidelines are offered.

I. APPLICATION DATA RATINGS

Diesel-Electric Power Generation

All ratings shown and thermal ratings are subject to manufacturing tolerances of ± 3 percent.

When using a generator set, use the following guidelines to determine whether standby, prime, prime plus 10 percent, or continuous rating applies.

STANDBY RATING:

Typical load factor = 60 percent or less

Typical hours/year = 100 h

Typical peak demand = 80 percent of standby-rated kilowatts with 100 percent of rating available for the duration of an emergency outage

Enclosure/sheltered environment

PRIME + 10 PERCENT RATING:

Typical load factor = 60 percent or less

Typical hours/year = 500 h

Typical demand = 80 percent of standby-rated kilowatts with 100 percent of rating available for the duration of an emergency outage

Typical application = Standby, rental, power module, unreliable utility, or interruptible rates

PRIME RATING:

Typical load factor = 60 to 70 percent

Typical hours/year = No limit

Typical peak demand = 100 percent of prime-rated kilowatts used occasionally, but for less than 10 percent of operating hours

Typical application = Industrial, pumping, construction, peak shaving, or cogeneration

CONTINUOUS RATING:

Typical load factor = 70 to 100 percent

Typical hours/year = No limit

Typical peak demand = 100 percent of continuous-rated kilowatts for 100 percent of operating hours

Typical application = Base load, utility, cogeneration, or peak shaving

For conditions outside the above limits, refer to the manufacturer.

Operating units above these rating definitions will result in a shorter life until overhaul.

Gas-Electric Power Generation

All ratings shown and thermal ratings are subject to manufacturing tolerances of ± 3 percent.

When using a generator set, use the following guidelines to determine whether standby or continuous rating applies.

Remember the typical load factor is the sum of the loads a generator set experiences while it is running under load divided by the number of hours it operates under those loads. Extended idling time and the time when the generator is not operating do not enter into the calculation for load factor.

STANDBY RATING:

Adds 5 percent to continuous rating when using natural gas. When using other fuels, contact manufacturer. Applies to all gas engine-generator sets.

Typical load factor = 60 percent or less

Maximum hours/year = 100 h

Typical peak demand = 80 percent of standby-rated kilowatts with 100 percent of rating available for the duration of the emergency outage

Typical application = Building service standby and enclosure/sheltered environment

CONTINUOUS RATING:

Typical load factor = 70 to 100 percent

Typical hours/year = No limit

Typical peak demand = 100 percent of continuous-rated kilowatts for 100 percent of operating hours

Typical application = Base load, utility, cogeneration, or peak shaving

For conditions outside the above limits, refer to the manufacturer.

Operating units above these rating definitions will result in shorter life until overhaul and possible catastrophic failure.

Power for gas engines is based on fuel having a low heating value (LHV) of 33.74 kJ/L (905 Btu/ft³) for pipeline natural gas.

Propane ratings are based on having an LHV of 85.75 kJ/L (2300 Btu/ft³). Landfill gas ratings are based on fuel having an LHV of 16.78 kJ/L (450 Btu/ft³). Digester gas ratings are based on fuel having an LHV of 22.37 kJ/L (600 Btu/ft³). The gas volume is based on conditions of 101 kPa (29.88 in Hg) and 15.5°C (60°F). Variations in altitude, temperature, and gas composition from standard conditions may require a reduction in engine horsepower.

II. LOADS

All resistive and inductive loads are summarized. Information from motor nameplates are as noted whenever possible. Table 5.7 approximates motor efficiencies.

III. ENGINE SIZING

Total engine load is determined by calculating effects of motor efficiencies and adding to resistive loads.

IV. ENGINE SELECTION

Consideration of load (kW), frequency (Hz), speed (rpm), and engine configuration (gas, diesel, turbocharged, aftercooled, naturally aspirated) allow engine selection from Table 5.4.

V. GENERATOR SIZING

Generator capacity (kVA) is determined not only by total load but by motor size, configuration, starting sequence, and possible motor-starting aids. Minimize motor-starting requirements by starting largest motors first. Random-starting sequence requires worst-case application by starting smallest motors first. Use Table 5.5 to calculate starting kVA (SKVA) or full-load amperes.

Effective SKVA

Motors on-line diminish generator capability (SKVA) to start additional motors (Figure 5.8). Reduced-voltage starting decreases demand on the generator (Table 5.6), but also reduces the torque capability of the motor.

Select a generator that provides motor-starting requirements (SKVA) with acceptable voltage dip (Table 5.4).

Voltage dip is measured on an oscilloscope as SKVA, noted in Table 5.4, while driven by a synchronized motor.

TABLE 5.4 Motor Starting Data Diesel and Gas Generator Sets

PRIME POWER — 60 Hz-1200 RPM*

Engine Model	Generator	Rating w/Fan kW	Starting kV·A at Voltage Dip**		
	Frame		10%	20%	30%
3516 TA	809	1100	788	1773	3039
3516 TA	806	900	444	1000	1714
3512 TA	806	830	444	1000	1714
3512 TA	687	650	411	925	1587
3508 TA	686	550	277	625	1071
3508 TA	683	425	231	520	892
3412 TA	587	325	214	481	824
3408 TA	585	225	161	362	621
3406 TA	583	170	142	321	549

* ISO power with 10% overload capability except as noted by ***.

** Noted SKVA values are for low voltage (below 800V) generators. Consult Caterpillar for medium voltage generator capabilities.

NOTE: SCR rectifiers and variable speed motor controls require detailed analysis. Contact Caterpillar and the SCR supplier.

TABLE 5.4 Motor Starting Data Diesel and Gas Generator Sets (*Continued*)

PRIME POWER — 60 Hz-1800 RPM*						
Engine Model	Generator	Rating w/Fan	Starting kV•A at Voltage Dip**			
	Frame	kW	10%	20%	30%	
3516 TA	807	1600	1234	2777	4761	
	806	1360	1010	2272	3896	
3512 TA	889	1135	966	2173	3726	
	887	1000	888	2000	3428	
	685	910	584	1315	2255	
3508 TA	685	820	584	1315	2255	
	681	725	419	943	1617	
	681	680	419	943	1617	
	589	650	396	892	1530	
3412 TA T T	589	545	444	1000	1714	
	588	455	317	714	1224	
	586	425	278	625	1071	
3408 TA	584	365	242	543	932	
3406 TA #0 TA #1 TA	450	320	188	424	726	
	449	275	171	385	659	
	448	250	159	357	612	
3306 ATAAC TA TA	447	225	142	321	549	
	446	205	139	313	536	
	446	180	139	313	536	
3208 T	443	160	111	250	428	

* ISO power with 10% overload capability except as noted by ***.

** Noted SKVA values are for low voltage (below 600V) generators. Consult Caterpillar for medium voltage generator capabilities.

TABLE 5.4 Motor Starting Data Diesel and Gas Generator Sets (*Continued*)

STANDBY POWER — 60 Hz-1200 RPM						
Engine Model	Generator	Rating w/Fan	Starting kV•A at Voltage Dip**			
	Frame	kW	10%	20%	30%	
3516 TA	809	1250	788	1773	3039	
3516 TA	806	975	444	1000	1714	
3512 TA	806	925	444	1000	1714	
3512 TA	687	700	411	925	1587	
3508 TA	686	615	277	625	1071	
3508 TA	683	465	231	520	892	
3412 TA	587	355	214	481	824	
3408 TA	585	245	161	362	621	
3406 TA	583	185	142	321	549	

** Noted SKVA values are for low voltage (below 800V) generators. Consult Caterpillar for medium voltage generator capabilities.
NOTE: SCR rectifiers and variable speed motor controls require detailed analysis. Contact Caterpillar and the SCR supplier.

TABLE 5.4 Motor Starting Data Diesel and Gas Generator Sets (*Continued*)

STANDBY POWER — 60 Hz-1800 RPM						
Engine Model	Generator	Rating w/Fan	Starting kV-A at Voltage Dip			
	Frame	kW	10%	20%	30%	
3516 TA	808	2000	1355	3048	5226	
	807	1750	1234	2777	4761	
3512 TA	806	1500	1010	2272	3896	
	805	1400	793	1785	3061	
	689	1250	966	2173	3726	
	687	1100	888	2000	3428	
3508 TA	685	1000	584	1315	2255	
	685	900	584	1315	2255	
	681	800	419	943	1617	
	681	750	419	943	1617	
	589	700	396	892	1530	
3412 TA T T	589	600	444	1000	1714	
	588	500	317	714	1224	
	586	475	278	625	1071	
3408 TA	584	400	242	543	932	
3406 TA	449	350	218	490	840	
	448	300	202	455	779	
	447	275	161	362	821	
3306 ATAAC T	446	250	156	352	604	
	445	225	146	329	564	
3208 ATAAC T	444	200	123	278	476	
	443	175	93	208	357	

** Noted SKVA values are for low voltage (below 600V) generators. Consult Caterpillar for medium voltage generator capabilities.
NOTE: SCR rectifiers and variable speed motor controls require detailed analysis. Contact Caterpillar and the SCR supplier.

TABLE 5.4 Motor Starting Data Diesel and Gas Generator Sets (*Continued*)

CONTINUOUS POWER — 60 Hz-1800 RPM						
Engine Model	Type °C (°F)/Ratio	Generator	Rating w/o Fan	Starting kV•A at Voltage Dip		
		Frame	kW	10%	20%	30%
3412 TA	32 (90)	588	460	317	714	1224
	54 (130)	586	410	278	625	1071
3408 TA	32 (90)	582	300	171	385	659
	54 (130)	582	270	171	385	659
3306 TA TA NA NA	HCR	445	150	111	250	428
	LCR	444	135	74	167	286
	HCR	444	100	74	167	286
	LCR	444	85	74	167	286
CONTINUOUS POWER — 60 Hz-1200 RPM						
G3516 LE LE NA	32 (90)	807	820	444	1000	1714
	54 (130)	807	770	444	1000	1714
	—	686	465	231	521	893
G3512 LE LE NA	32 (90)	686	600	278	625	1071
	54 (130)	686	570	278	625	1071
	—	683	365	231	521	893
G3508 LE LE NA	32	683	395			
	54	683	375			
	—	683	210			

** Noted SKVA values are for low voltage (below 600V) generators. Consult Caterpillar for medium voltage generator capabilities.
NOTE: SCR rectifiers and variable speed motor controls require detailed analysis. Contact Caterpillar and the SCR supplier.
10% overload of TA engines can be factory demonstrated.

TABLE 5.5 Code Letters on AC Motors

NEMA Code Letter	SKVA per hp	Mid-Value
A	0.00- 3.14	1.57
B	3.15- 3.54	3.34
C	3.55- 3.99	3.77
D	4.00- 4.49	4.24
E	4.50- 4.99	4.74
F	5.00- 5.59	5.30
G	5.60- 6.29	5.94
H	6.30- 7.09	6.70
J	7.10- 7.99	7.54
K	8.00- 8.99	8.50
L	9.00- 9.99	9.50
M	10.00-11.19	10.60
N	11.20-12.49	11.84
P	12.50-13.99	13.24
R	14.00-15.99	15.00
S	16.00-17.99	17.00
T	18.00-19.99	19.00
U	20.00-22.39	21.20
V	22.40-	

Use 6.0 if code letter unknown

Wound Rotor Motor has no code letter

VI. GENERATOR SET SIZING

Match engine-running load (kW) with generator motor-starting requirements (SKVA) to satisfy application. Table 5.7 will assist in determining running load kW for squirrel cage induction motors. Engines and generators may be interchanged with model configurations, but mechanical considerations should be reviewed with the manufacturer.

Silicon-controlled rectifiers (SCRs) and variable-speed motor controls require detailed analysis. These should be reviewed with the respective manufacturers.

In Figure 5.9, panel *a* shows a sample generator sizing calculation, and panel *b* provides a blank form for the reader's use.

Critical Installation Considerations

The following summary contains important points to remember for a successful generator installation:

1. The generator set must be sized properly for the installation. Determine the duty cycle: continuous, prime, standby, or peak shaving or sharing (paralleled or not paralleled with the utility).

FIGURE 5.8 Motor preload multiplier.

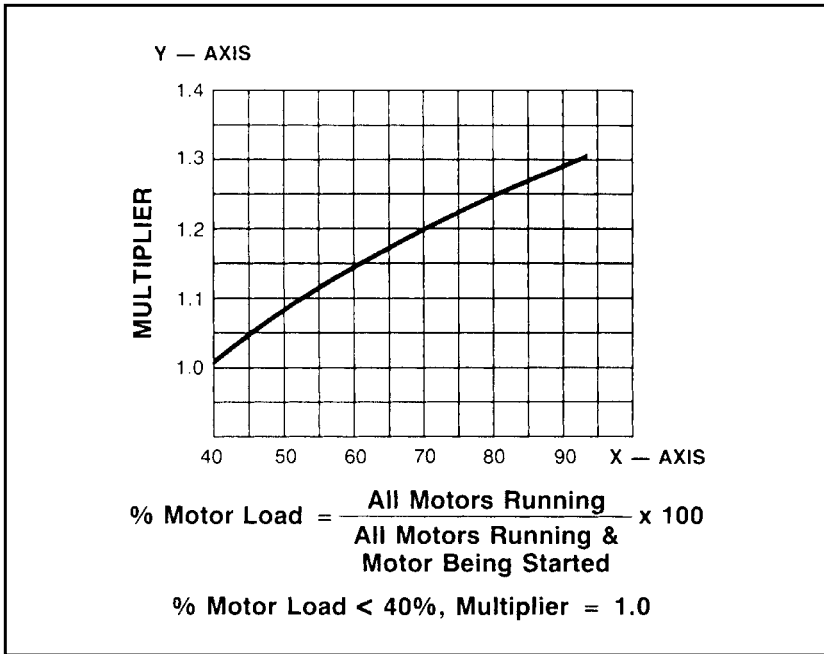

Continuous: Output available without varying load for an unlimited time.

Prime: Output available with varying load for an unlimited time.

Standby: Output available with varying load for the duration of the interruption of the normal source of power. The standby duty cycle is usually sized initially for 60 percent of actual load, because loads tend to increase during the 30-year life of the unit. Normal hours of operation are less than 100 h per year.

Peak shaving/sharing: Prime if paralleled with the utility, standby if not paralleled with the utility and if the load meets the definition of prime or standby. Normally peak shaving/sharing is less than 200 h per year of operation.

Loads that are too light cause engine slobber. Overloading causes excessive piston loading and high exhaust temperatures.

Standby engines that must be exercised regularly but cannot be loaded should only be run long enough to achieve normal oil pressure and then shut off—less than 5 min of running time. Good practice dic-

TABLE 5.6 Reduced-Voltage Starting Factors

Type	Multiply SKVA By
Resistor, Reactor, Impedance	
80% Tap	0.80
65% Tap	0.65
50% Tap	0.50
45% Tap	0.45
Autotransformer	
80% Tap	0.68
65% Tap	0.46
50% Tap	0.29
Y Start, Run	0.33
Solid State: Adjustable, consult manufacturer or estimate 300% of full load kV•A (Use 1 if no reduced voltage starting aids used)	

tates that this be done weekly and that once a month the generators be run under load for a half hour or so, then unloaded briefly for cool-down. The load should be at least two-thirds of capacity, either using a dummy resistive load bank, or preferably under actual building load. The latter requirement is mandatory for hospitals under NFPA 99.

2. The generator set must be properly installed in an atmosphere that allows it to achieve the required life.

TABLE 5.7 Approximate Efficiencies—Squirrel Cage Induction Motors

hp	kW	Full-Load Efficiency
5-7½	4-6	0.83
10	7.5	0.85
15	11	0.86
20-25	15-19	0.89
30-50	22-37	0.90
60-75	45-56	0.91
100-300	74.6-224	0.92
350-600	261-448	0.93

FIGURE 5.9 Generator sizing chart. (a) Filled-out sample. (b) Blank.

Customer _____ Project _____ Analyst _____ Date _____

I. APPLICATION DATA
 Prime/Standby Power _____ Gas/Diesel Fuel _____ 480 Volts _____ 3 Phase _____ 60 Hz

II. LOADS
 A. Lighting Loads _____ 75 kW
 B. Other Non-Motor Loads _____ 25 kW
 C. Motors _____ (Motor) x 0.746

III. ENGINE SIZING

Starting Sequence	hp	Nema Code	Reduced Voltage Starting Type	Acceptable Voltage Dip Percent	Motor Eff. %	Motor Efficiency (Chart 5)
1	<u>200</u>	<u>F</u>	<u>Res. 65%</u>	<u>20</u>	<u>92</u>	<u>162</u> kW
2	<u>75</u>	<u>G</u>	<u>A-T 80%</u>	<u>20</u>	<u>91</u>	<u>41</u> kW
3	<u>60</u>	<u>F</u>	<u>Across the line</u>	<u>20</u>	<u>91</u>	<u>49</u> kW
4	<u>50</u>	<u>F</u>	<u>Across the line</u>	<u>20</u>	<u>90</u>	<u>41</u> kW
5						

Total Motor Load _____ 313 kW
 Total Engine Load (A + B + C) _____ 413 kW

IV. ENGINE SELECTION Model: 3412 T S Frame: 586 Rating (With Fan): 425 kW 60 Hz 1800 rpm

V. GENERATOR SIZING Start Sequence _____

	Motor(s) 1	Motor(s) 2	Motor(s) 3	Motor(s) 4	Motor(s) 5
A. Starting kV*A (SKVA)					
1. Motor Ratings	<u>200</u> hp	<u>75</u> hp	<u>60</u> hp	<u>50</u> hp	_____ hp
2. NEMA Code	<u>F</u>	<u>G</u>	<u>F</u>	<u>F</u>	_____
3. SKVA/hp (Use 6.0 if Code Letter Unknown)	<u>5.30</u>	<u>5.94</u>	<u>5.30</u>	<u>5.30</u>	_____
4. SKVA/hp x Motor hp (A.1 x A.3)	<u>1060</u> SKVA	<u>446</u> SKVA	<u>318</u> SKVA	<u>265</u> SKVA	_____ SKVA
B. Effective SKVA					
1. All Motors Running	<u>0</u> kW	<u>162</u> kW	<u>223</u> kW	<u>272</u> kW	_____ kW
2. All Motors Running & Motor Being Started	<u>162</u> kW	<u>223</u> kW	<u>272</u> kW	<u>313</u> kW	_____ kW
B.1					
3. B.2 x 100	<u>0</u> %	<u>73</u> %	<u>82</u> %	<u>87</u> %	_____ %
B.2					
4. Compensation for Motors Already Started (Chart 2)	<u>1.0</u>	<u>1.21</u>	<u>1.26</u>	<u>1.28</u>	_____
5. Step A.4. x Step B.4.	<u>1060</u> SKVA	<u>540</u> SKVA	<u>401</u> SKVA	<u>339</u> SKVA	_____ SKVA
6. Reduced Voltage Factor (Chart 3) (use 1.0 if no starting aid used)	<u>.65</u>	<u>.68</u>	<u>1.0</u>	<u>1.0</u>	_____
7. Effective SKVA = Step B.5. x B.6.	<u>689</u> SKVA	<u>367</u> SKVA	<u>401</u> SKVA	<u>339</u> SKVA	_____ SKVA
8. Acceptable Voltage Dip (10, 20, 30%)	<u>20</u> %	<u>20</u> %	<u>20</u> %	<u>20</u> %	_____ %
C. Generator Selection (Chart 1)					
1. Frame	<u>588</u>	<u>449</u>	<u>584</u>	<u>448</u>	_____
2. Rating	<u>455</u> kW	<u>225</u> kW	<u>365</u> kW	<u>225</u> kW	_____ kW
3. SKVA at Selected Voltage Dip	<u>714</u>	<u>385</u>	<u>543</u>	<u>357</u>	_____

VI. GENERATOR SET SIZING
 Select Largest Generator Set Model of Step IV and Step V.C.1.
 Model: 3412 T S Frame: 588 Rating: 455 kW Prime/Standby _____ 60 Hz 1800 rpm



384

FIGURE 5.9 Generator sizing chart. (a) Filled-out sample. (b) Blank. (Continued)

Customer _____ Project _____ Analyst _____ Date _____

I. APPLICATION DATA
 Prime/Standby Power _____ Gas/Diesel Fuel _____ Volts _____ Phase _____ Hz _____

II. LOADS
 A. Lighting Loads _____ kW
 B. Other Non-Motor Loads _____ kW
 C. Motors

III. ENGINE SIZING
 hp (Motor) x 0.746
 Motor Efficiency (Chart 5)

Starting Sequence	hp	Nema Code	Reduced Voltage Starting Type	Acceptable Voltage Dip Percent	Motor Eff. (Chart 5)	kW (Engine)
1	_____	_____	_____	_____	_____	_____ kW
2	_____	_____	_____	_____	_____	_____ kW
3	_____	_____	_____	_____	_____	_____ kW
4	_____	_____	_____	_____	_____	_____ kW
5	_____	_____	_____	_____	_____	_____ kW
Total Motor Load						_____ kW
Total Engine Load (A + B + C)						_____ kW

IV. ENGINE SELECTION Model: _____ Frame: _____ Rating (With Fan): _____ kW _____ Hz _____ rpm

V. GENERATOR SIZING Start Sequence

	Motor(s) 1	Motor(s) 2	Motor(s) 3	Motor(s) 4	Motor (s) 5
A. Starting kV•A (SKVA)	_____	_____	_____	_____	_____
1. Motor Ratings	_____ hp	_____ hp	_____ hp	_____ hp	_____ hp
2. NEMA Code	_____	_____	_____	_____	_____
3. SKVA/hp (Use 6.0 if Code Letter Unknown)	_____	_____	_____	_____	_____
4. SKVA/hp x Motor hp (A.1 x A.3)	_____ SKVA	_____ SKVA	_____ SKVA	_____ SKVA	_____ SKVA
B. Effective SKVA	_____	_____	_____	_____	_____
1. All Motors Running	_____ kW	_____ kW	_____ kW	_____ kW	_____ kW
2. All Motors Running & Motor Being Started	_____ kW	_____ kW	_____ kW	_____ kW	_____ kW
3. $\frac{B.1}{B.2} \times 100$	_____ %	_____ %	_____ %	_____ %	_____ %
4. Compensation for Motors Already Started (Chart 2)	_____ 1.0	_____	_____	_____	_____
5. Step A.4. x Step B.4.	_____ SKVA	_____ SKVA	_____ SKVA	_____ SKVA	_____ SKVA
6. Reduced Voltage Factor (Chart 3) (use 1.0 if no starting aid used)	_____	_____	_____	_____	_____
7. Effective SKVA = Step B.5. x B.6.	_____ SKVA	_____ SKVA	_____ SKVA	_____ SKVA	_____ SKVA
8. Acceptable Voltage Dip (10, 20, 30%)	_____ %	_____ %	_____ %	_____ %	_____ %
C. Generator Selection (Chart 1)	_____	_____	_____	_____	_____
1. Frame	_____	_____	_____	_____	_____
2. Rating	_____ kW	_____ kW	_____ kW	_____ kW	_____ kW
3. SKVA at Selected Voltage Dip	_____	_____	_____	_____	_____

VI. GENERATOR SET SIZING
 Select Largest Generator Set Model of Step IV and Step V.C.1.
 Model: _____ Frame: _____ Rating: _____ kW Prime/Standby _____ Hz _____ rpm

NEMA

Air flow: Provide adequate clean, cool air for cooling and combustion. High engine room temperatures may require ducting cooler outside air to the engine intake to avoid power derating. Restriction of radiator air reduces its cooling capability.

Exhaust: Isolate exhaust piping from the engine with flexible connections. Wrap the piping with a thermal blanket to keep exhaust heat out of the engine room. The exhaust stack and muffler need to be sized so that the exhaust back pressure at the turbocharger outlet does not exceed 6.7 kPa (27 in) of water. Excessive back pressure raises exhaust temperatures and reduces engine life.

Fuel: Use clean fuel. Fuel day tanks should be below the level of the injectors.

Mounting: The generator sets must have a flat and secure mounting surface. The generator set mounting must allow adequate space around the generator set for maintenance and repairs.

Starting: Batteries should be close to the starter and protected from very cold temperatures. Do not disconnect batteries from a running engine or a plugged-in battery charger.

3. SCR loads can affect generator output waveform. Make sure the SCR supplier is aware of the possible problems.

Every generator set installation is unique and requires careful consideration of the particular application and site-specific conditions. It is therefore best to determine the foundation, ventilation, exhaust, fuel, vibration isolation, and other requirements in conjunction with the generator set manufacturer for the specific application and site conditions.

5.4 UNINTERRUPTIBLE POWER SUPPLY (UPS) SYSTEMS

A UPS is a device or system that provides quality and continuity of an AC power source. Every UPS should maintain some specified degree of continuity of load for a specified stored-energy time upon AC input failure [see NEMA PE1-1990 (“Uninterruptible Power Systems”)]. The term *UPS* commonly includes equipment, backup power source(s), environmental equipment (enclosure, heating and ventilating equipment), switchgear, and controls, which, together, provide a reliable, continuous-quality electric power system.

The following definitions are given for clarification:

1. *Critical load:* That part of the load that requires continuous-quality electric power for its successful operation.
2. *Uninterruptible power supply (UPS) system:* Consists of one or more UPS modules, energy storage battery (per module or com-

mon battery), and accessories (as required) to provide a reliable and high-quality power supply. The UPS isolates the load from the primary and emergency sources, and, in the event of a power interruption, provides regulated power to the critical load for a specified period depending on the battery capacity. (The battery is normally sized to provide a capacity of 15 min when operating at full load.)

3. *UPS module*: The power conversion portion of the UPS system. A UPS module may be made entirely of solid-state electronic construction, or a hybrid combining rotary equipment (motor-generator) and solid-state electronic equipment. A solid-state electronic UPS consists of a rectifier, an inverter, and associated controls along with synchronizing, protective, and auxiliary devices. UPS modules may be designed to operate either individually or in parallel. A rotary UPS consists of a pony motor, a motor-generator, or, alternatively, a synchronous machine in which the synchronous motor and generator have been combined into a single unit. This comprises a stator whose slots carry alternate motor and generator windings, and a rotor with DC excitation, a rectifier, an inverter, a solid-state transfer switch, and associated controls along with synchronizing, protective, and auxiliary devices.
4. *Nonredundant UPS configuration*: Consists of one or more UPS modules operating in parallel with a bypass circuit transfer switch and a battery (see Figure 5.10). The rating and number of UPS modules are chosen to supply the critical load with no intentional excess capacity. Upon the failure of any UPS module, the bypass circuit automatically transfers the critical load to the bypass source without an interruption. The solid-state electronic UPS configuration relies upon a static transfer switch for transfer within 4.17 milliseconds (ms). The rotary UPS configuration relies upon the stored energy of the flywheel to propel the generator and maintain normal voltage and frequency for the time that the electro-mechanical circuit breakers are transferring the critical load to the alternate source. All operational transfers are “make before break.”
5. *“Cold” standby redundant UPS configuration*: Consists of two independent, nonredundant modules with either individual module batteries or a common battery (see Figure 5.11). One UPS module operates on the line, and the other UPS module is turned off. Should the operating UPS module fail, its static bypass circuit will automatically transfer the critical load to the bypass source without an interruption to the critical load. The second UPS module is then manually energized and placed on the bypass mode of operation. To transfer the critical load, external make-before-break nonautomatic circuit breakers are operated to place the

FIGURE 5.10 Nonredundant UPS system configuration. (From IEEE Std. 241-1990. Copyright 1990 IEEE. All rights reserved.)

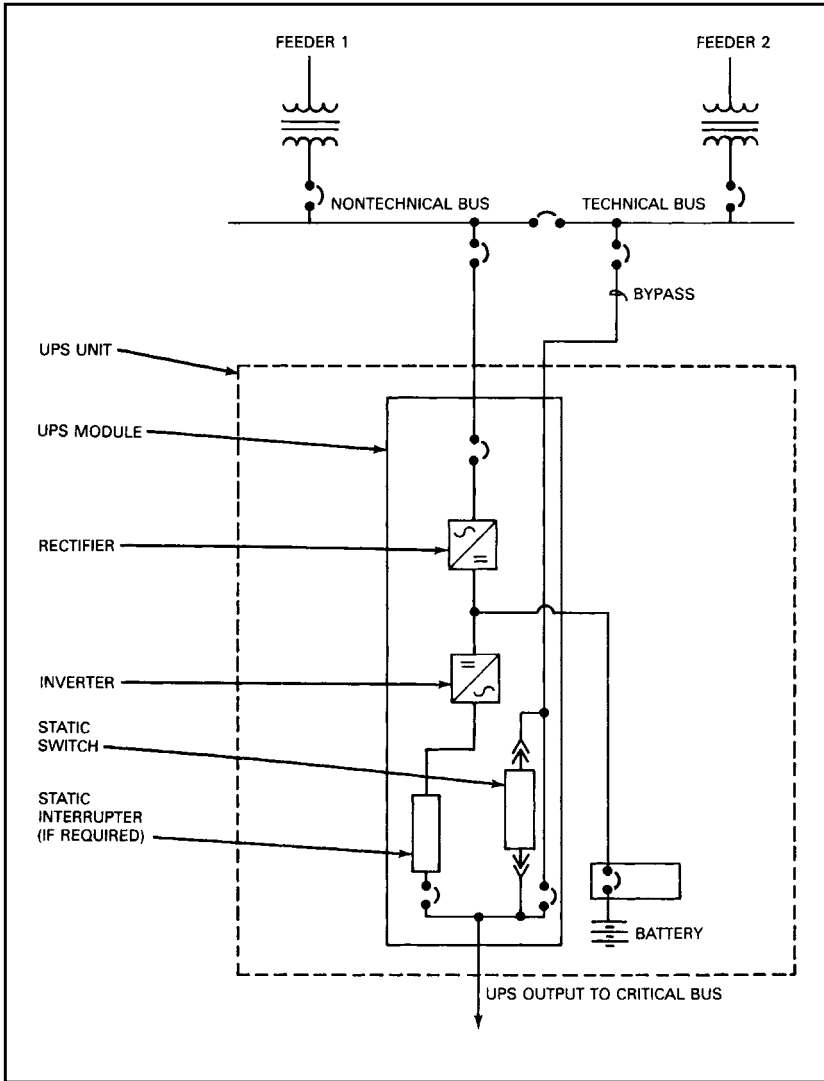

load on the second UPS bypass circuit. Finally, the critical load is returned from the bypass to the second UPS module via the bypass transfer switch. The two UPS modules cannot operate in parallel; therefore, a safety interlock circuit should be provided to prevent this condition. This configuration is rarely used.

FIGURE 5.11 “Cold” standby redundant UPS system. (From IEEE Std. 241-1990. Copyright 1990 IEEE. All rights reserved.)

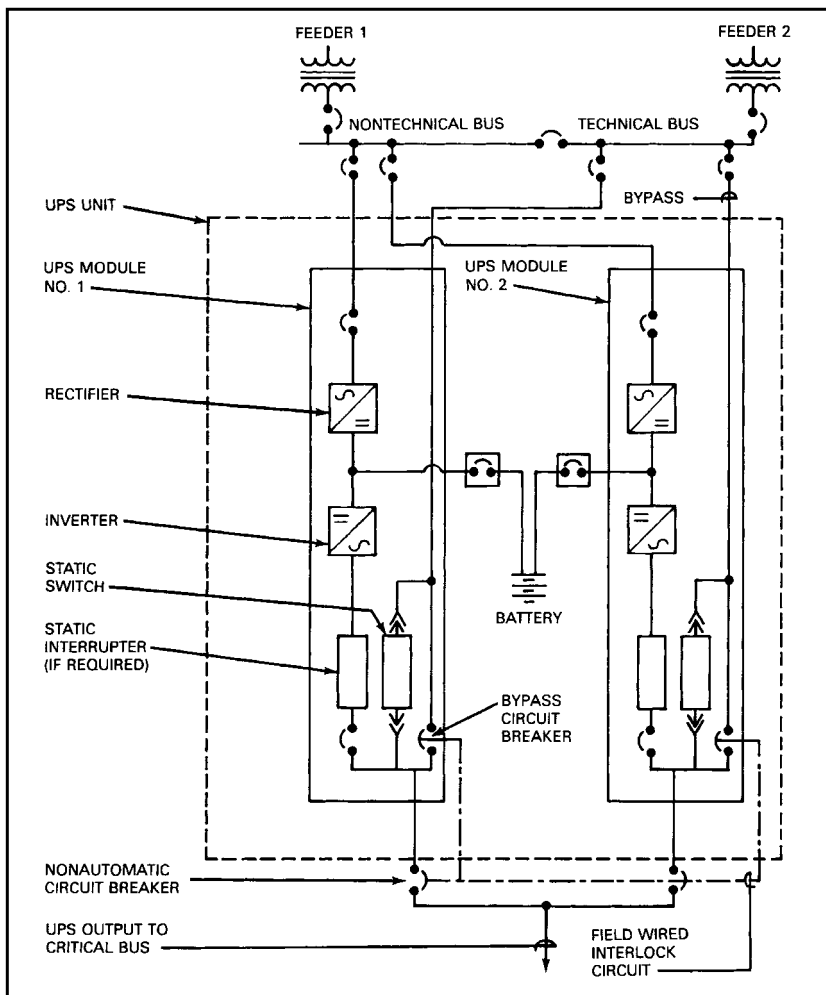

6. *Parallel redundant UPS configuration:* Consists of two or more UPS modules with static inverter turnoff(s), a system control cabinet, and either individual module batteries or a common battery (see Figure 5.12). The UPS modules operate in parallel and normally share the load, and the system is capable of supplying the rated critical load upon failure of any one UPS module. A static interrupter will disconnect the failed UPS module from the other UPS modules without an interruption to the critical load. A system bypass is usually included to permit system maintenance.

FIGURE 5.12 Parallel redundant UPS system. (From IEEE Std. 241-1990. Copyright 1990. All rights reserved.)

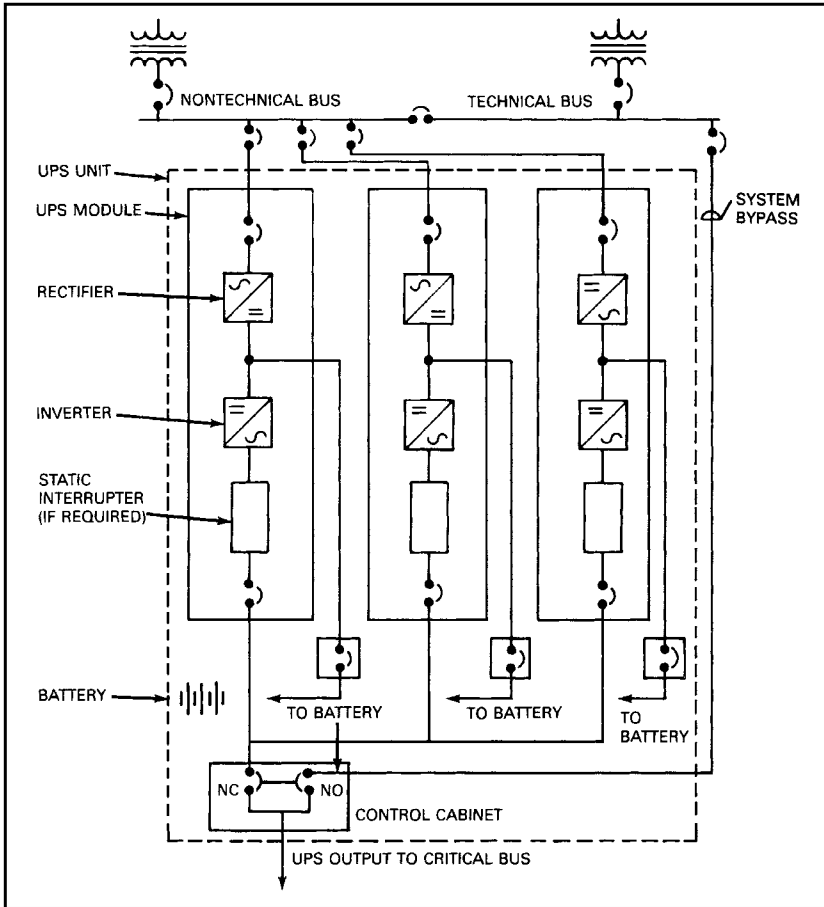

7. *Isolated redundant UPS configuration:* Uses a combination of automatic transfer switches and a reserve system to serve as the bypass source for any of the active systems (in this case, a system consists of a single module with its own system switchgear). This is shown in Figure 5.13. The use of this configuration requires each active system to serve an isolated/independent load. The advantage of this type of configuration minimizes single-point failure modes (i.e., systems do not communicate via logic connections with each other; the systems operate independently of one another). The disadvantage of this type of system is that each system requires its own separate feeder to its dedicated load.

FIGURE 5.13 Isolated redundant UPS system. (From IEEE Std. 241-1990. Copyright 1990 IEEE. All rights reserved.)

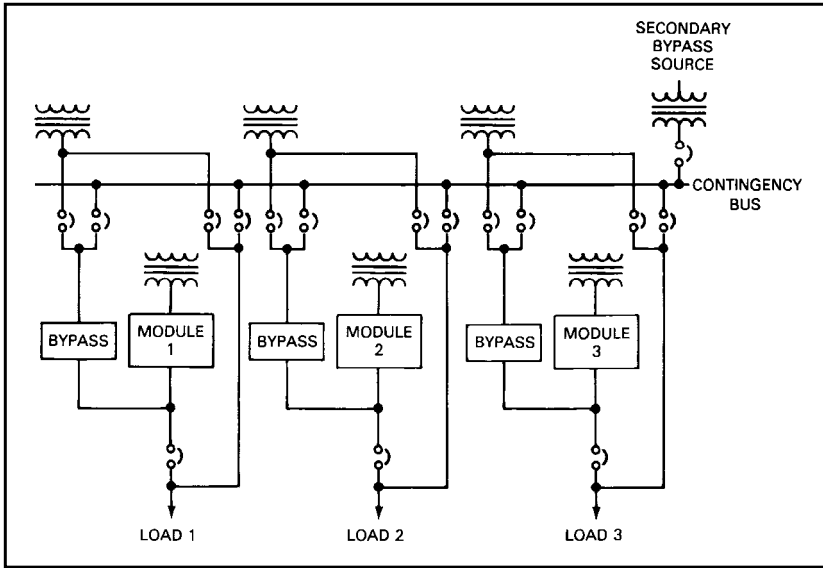

Application of UPS

1. The nonredundant UPS may be satisfactory for many critical load applications.
2. The installation of a parallel redundant UPS system is justified when the criticality of the load demands the greatest protection and the load cannot be divided into suitable blocks.

Power System Configuration for 60-Hz Distribution

In 60-Hz power distribution systems, the following basic concepts are used:

1. *Single-module UPS system:* A single unit that is capable of supplying power to the total load (see Figure 5.14). In the event of an overload or if the unit fails, the critical bus is transferred to the bypass source via the bypass transfer switch. Transfer is uninterrupted.
2. *Parallel capacity UPS system:* Two or more units capable of supplying power to the total load (see Figure 5.15). In the event of overload, or if either unit fails, the critical load bus is transferred to the bypass source via the bypass transfer switch. Transfer is uninterrupted. The battery may be common or separate.

FIGURE 5.14 Single-module UPS system. (From IEEE Std. 241-1990. Copyright 1990 IEEE. All rights reserved.)

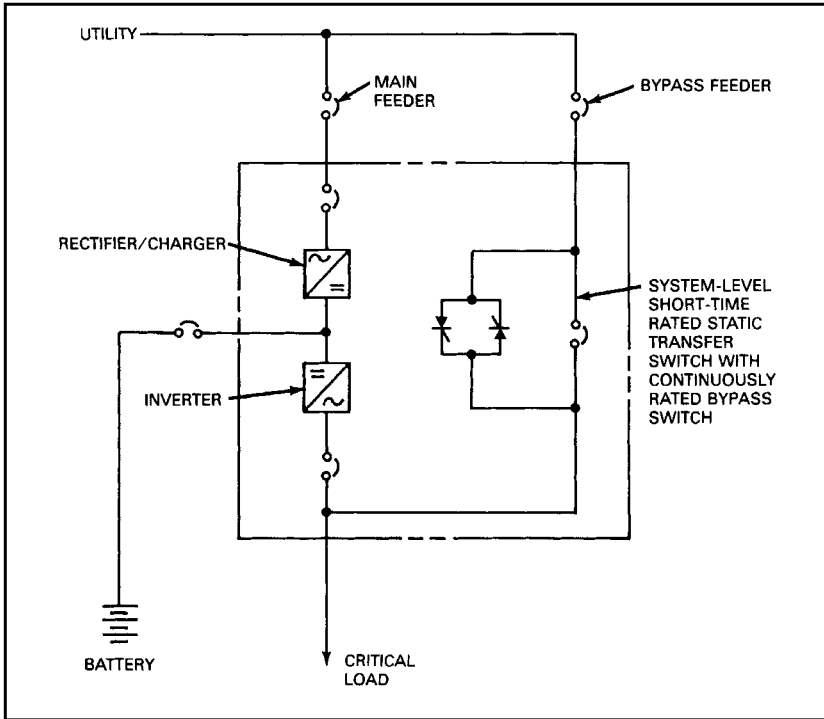

3. *Parallel redundant UPS system:* Two or more units with more capacity than is required by the total load (see Figure 5.16). If any unit fails, the remaining units should be capable of carrying the total load. If more than one unit fails, the critical bus will be transferred to the bypass source via the bypass transfer switch. The battery may be common or separate per module.
4. *Dual redundant UPS systems:* One UPS module is standing by, running unloaded (see Figure 5.17). If the loaded module fails, the load is transferred to the standby module. Each rating is limited to the size of the largest available module.
5. *Isolated redundant UPS system:* Multiple UPS modules, usually three, are individually supplied from transformer sources (see Figure 5.18). Each UPS module supplies a critical load and is available to supply a common contingency bus. The common contingency bus supplies the bypass circuit for each UPS module. In addition to being supplied from the common contingency bus, the bypass switch of each module is supplied from an individual trans-

FIGURE 5.15 Parallel capacity UPS system. (From IEEE Std. 241-1990. Copyright 1990 IEEE. All rights reserved.)

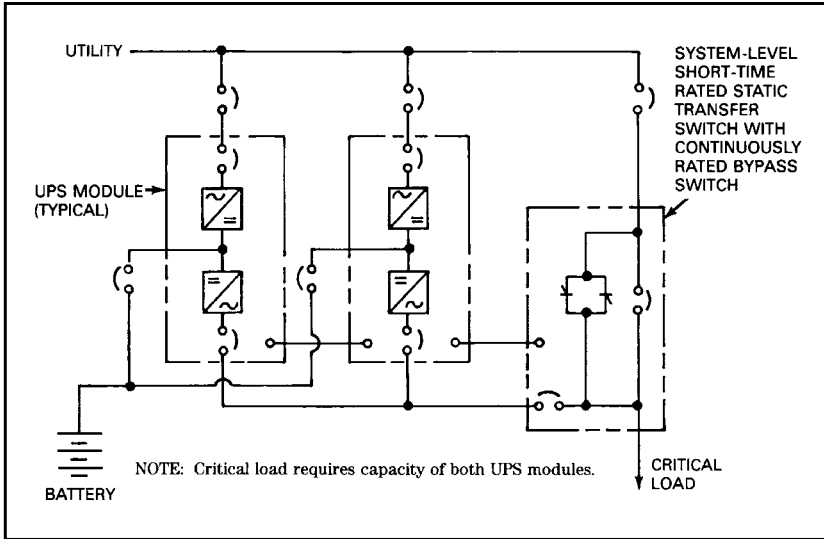

FIGURE 5.16 Parallel redundant UPS system. (From IEEE Std. 241-1990. Copyright 1990 IEEE. All rights reserved.)

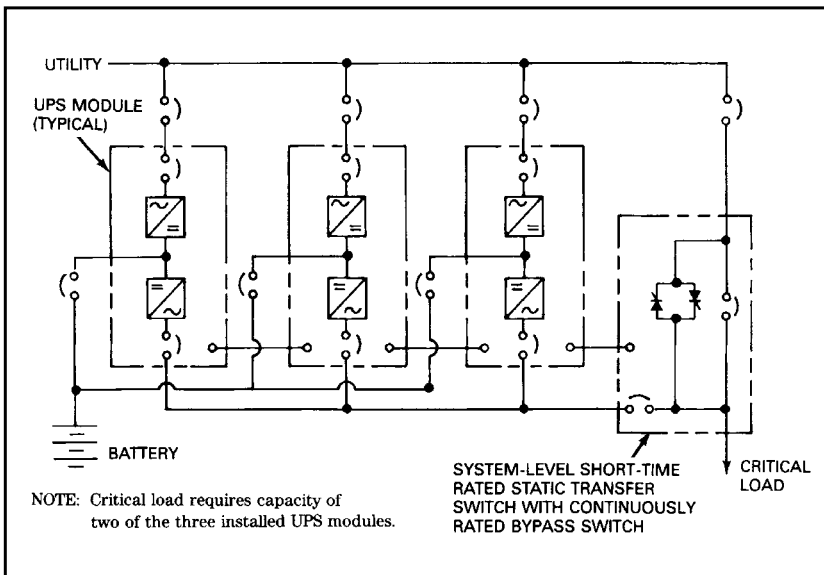
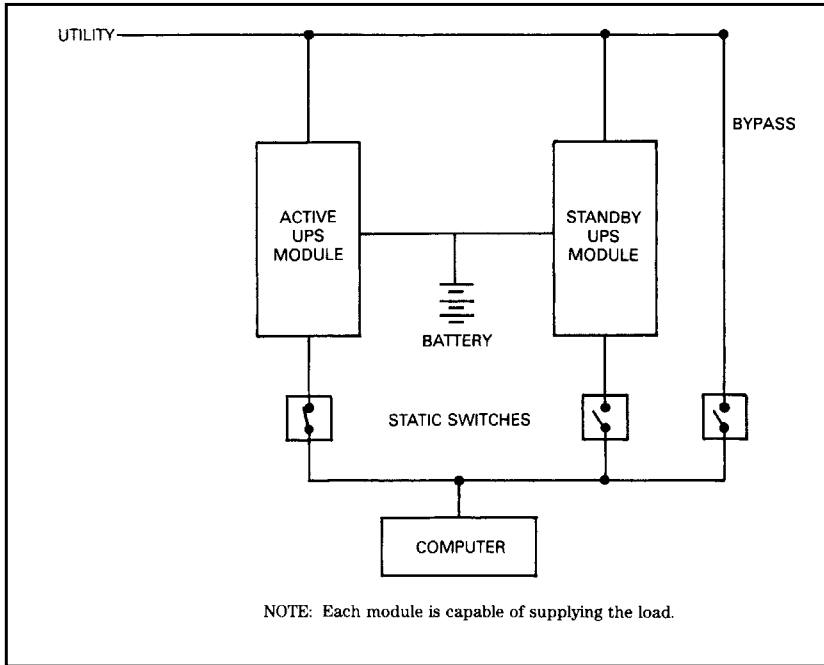

FIGURE 5.17 Dual redundant UPS system. (From IEEE Std. 241-1990. Copyright 1990 IEEE. All rights reserved.)



former source. Furthermore, the common contingency bus is also supplied from a separate standby transformer called a *secondary bypass source*. The arrangement includes one UPS module in reserve as a “hot” standby. When a primary UPS module fails, the reserve UPS module is transferred to the load.

6. *Parallel tandem UPS system:* The tandem configuration is a special case of two modules in parallel redundancy (see Figure 5.19). In this arrangement, both modules have rectifier/chargers, DC links, and inverters; also, one of the modules houses the system-level static transfer switch. Either module can support full system load while the other has scheduled or corrective maintenance performed.
7. *Hot tied-bus UPS system:* The UPS tied-bus arrangement consists of two individual UPS systems (single module, parallel capacity, or redundant), with each one supplying a critical load bus (see Figure 5.20). The two critical load buses can be paralleled via a tie breaker (normally open) while remaining on inverter power, which allows greater user flexibility for scheduled maintenance or damage control due to various failures.

FIGURE 5.18 Isolated redundant UPS system. (From IEEE Std. 241-1990. Copyright 1990 IEEE. All rights reserved.)

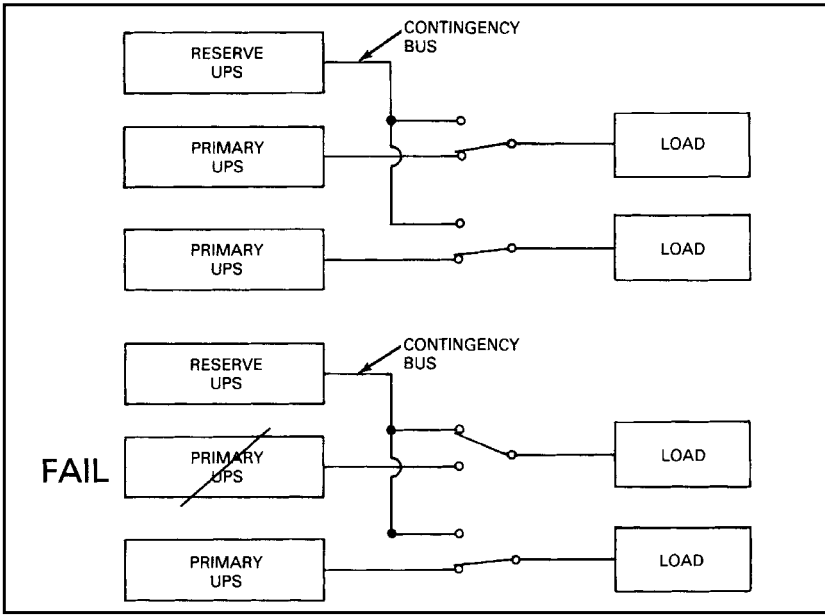

FIGURE 5.19 Parallel tandem UPS system. (From IEEE Std. 241-1990. Copyright 1990 IEEE. All rights reserved.)

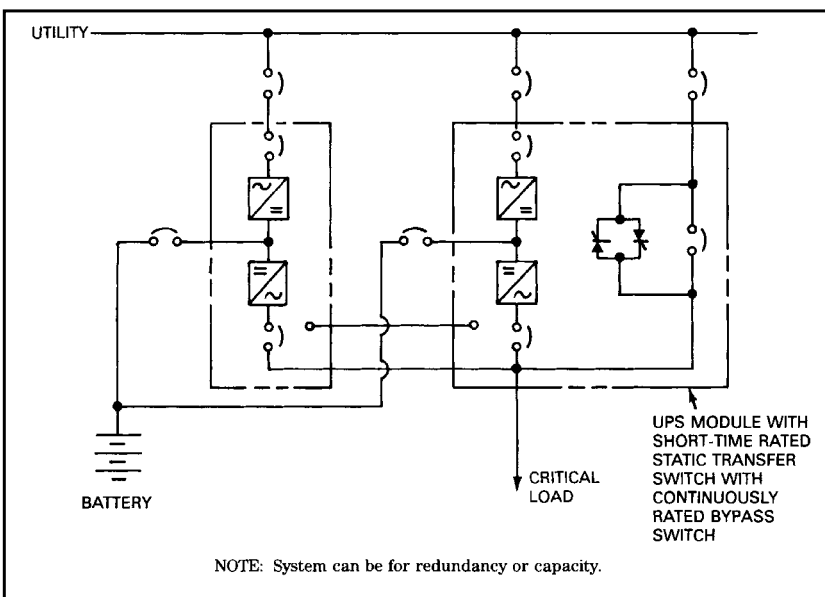
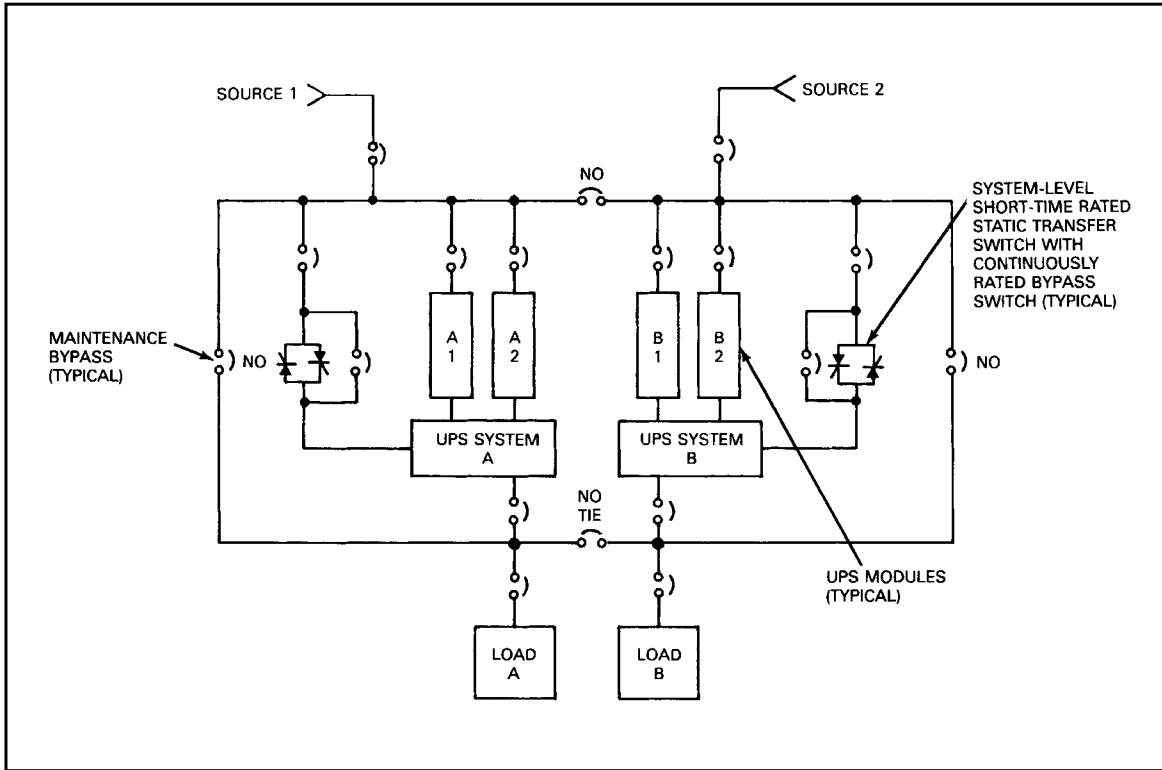

FIGURE 5.20 Hot tied-bus UPS system. (From IEEE Std. 241-1990. Copyright 1990 IEEE. All rights reserved.)



8. *Superredundant parallel system–hot tied-bus UPS system:* The superredundant UPS arrangement consists of n UPS modules (limited by a 4000-A bus). Each UPS module is supplied from dual sources (either/or) to supply two critical paralleling buses. Each paralleling bus is connected via a circuit breaker to a common bus in parallel with the output feeder of one of the system static bypass switches. This junction is connected via a breaker to a system critical load bus. A tie enables the two system critical load buses to be paralleled. Bypass sources for each system supply their own respective static bypass switches and maintenance bypasses. The superredundant UPS arrangement normally operates with the tie breaker open between the two system critical load buses. When all UPS modules are supplying one paralleling bus, then the tie breaker is closed. All operations are preselected, automatic, and allow the user to do module- and system-level reconfigurations without submitting either critical load to utility power. See Figure 5.21.
9. *Uninterruptible power with dual utility sources and static transfer switches:* Essentially, uninterruptible electric power to the critical load may be achieved by the installation of dual utility sources, preferably from two separate substations, supplying secondary buses via step-down transformers as required (see Figure 5.22).

FIGURE 5.21 Superredundant parallel system–hot tied-bus UPS system. (From IEEE Std. 241-1990. Copyright 1990 IEEE. All rights reserved.)

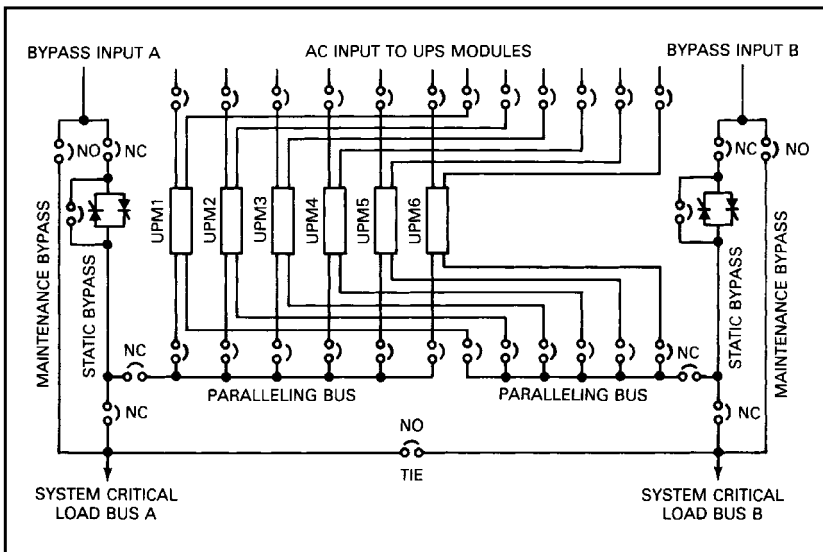
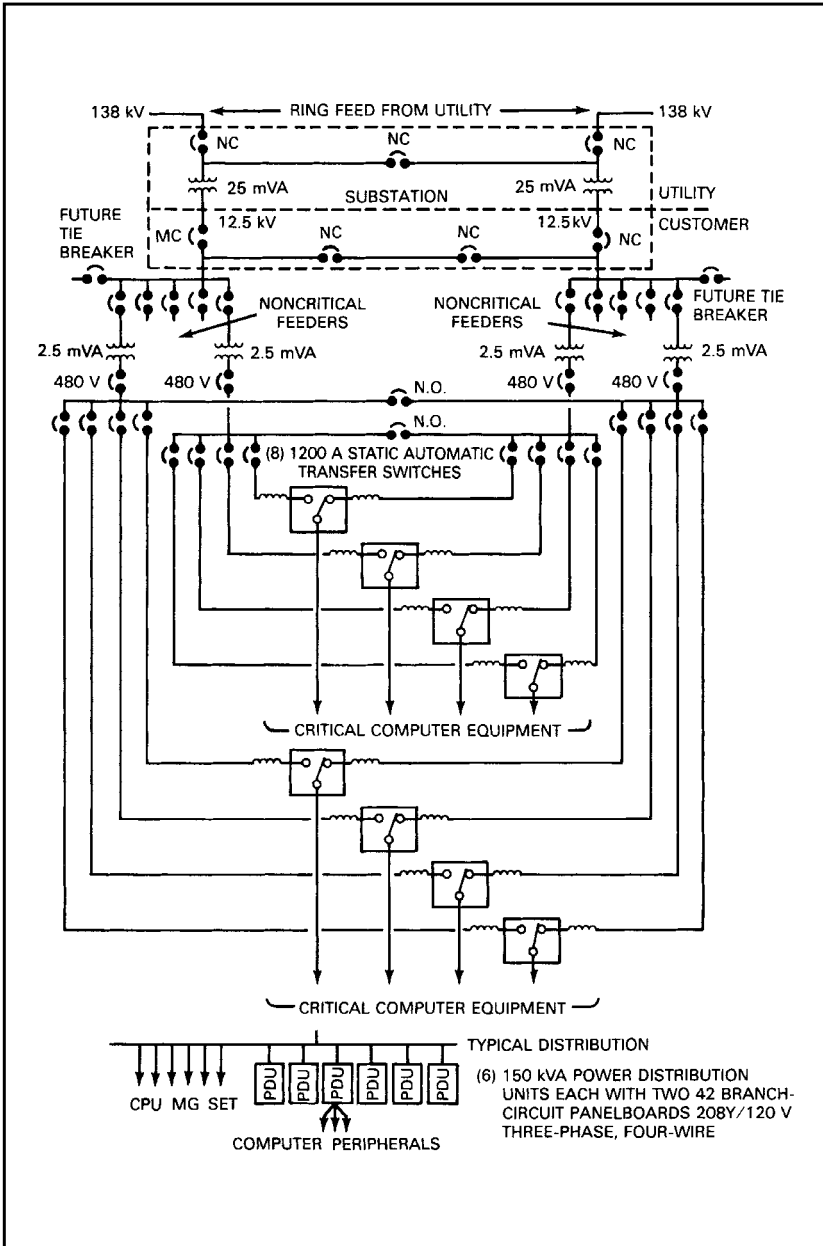

FIGURE 5.22 Uninterruptible power with dual utility sources and static transfer switches. (From IEEE Std. 241-1990. Copyright 1990 IEEE. All rights reserved.)



Feeders from each of two source buses are connected to static transfer switches as sources 1 and 2. A feeder from the load connection of the static transfer switch supplies a power line conditioner, if needed. The power line conditioner filters transients and provides voltage regulation. Filtered and regulated power is then supplied from the power line conditioner to the critical load distribution switchgear. This system eliminates the need for energy storage batteries, emergency generators, and other equipment. The reliability of this system is dependent upon the two utility sources and power conditioners.

Power System Configuration with 60-Hz UPS

1. *Electric service and bypass connectors:* Two separate electric sources, one to the UPS rectifier circuit and the other to the UPS bypass circuit, should be provided. When possible, they should emanate from two separate buses with the UPS bypass connected to the noncyclical load bus (also called the *technical bus*). This connection provides for the isolation of sensitive technical loads from the effects of UPS rectifier harmonic distortion and motor start-up current inrush.
2. *Maintenance bypass provisions:* To provide for the maintenance of equipment, bypass provisions are necessary to isolate each UPS module or system.

UPS Distribution Systems

The UPS serves critical loads only. Noncritical loads are served by separate distribution systems that are supplied from either noncyclical load bus (technical bus) or the cyclical load bus (nontechnical bus), as appropriate.

1. *Critical load protection:* Critical load overcurrent devices equipped with fast-acting fuses to shorten the transient effects of undervoltage caused by short circuits will result in a reliable system. Solid-state transient suppression (metal-oxide type) should also be supplied to lessen the overvoltage transients caused by reactive load switching.
2. *Critical motor loads:* Due to the energy losses and the starting current inrush inherent in motors, the connection of motors to the UPS bus should be limited to frequency conversion applications, that is, motor-generator sets. Generally, due to the current inrush, motor-generator sets are started on the UPS bypass circuit. Motor-generator sets may be started on the rectifier/inverter mode of operation under the following conditions:

- a. When the rating of the motor-generator set is less than 10 percent of the UPS rating.
- b. When reduced-voltage and peak current starters, such as the wye-delta closed transition type, are used for each motor load.
- c. When more than one motor-generator set is connected to the critical bus, each set should be energized sequentially rather than simultaneously.

Refer all applications requiring connection of induction and synchronous motor loads to the UPS manufacturer. Application rules differ depending on the design and rating of the UPS.

Power System Configuration for 400-Hz Distribution

In 400-Hz power distribution systems, the following basic concepts are used:

1. *Direct utility supply to dual-rotary frequency converters parallel at the output critical load bus:* Each frequency converter is sized for 100 percent load or the arrangement has redundant capacity. The frequency converters may be equipped with an inverter/charger and battery upon utility failure. Transfer from the utility line to the inverter occurs by synchronizing the inverter to the residual voltage of the motor.
2. *Dual-utility supply:* Dual-utility feeders supply an automatic transfer switch. The automatic transfer switch supplies multiple-rotary frequency converters (flywheel equipped). The frequency converters are parallel at the critical load bus. Transfer from one utility line to another occurs within the ride-through capability of the rotary frequency converters.
3. *UPS:* A static or rotary UPS supplies multiple-frequency converters and other 60-Hz loads.
4. *UPS with local generation backup:* Both the utility feeder (connected to the normal terminals) and the feeder from the backup generation (connected to the emergency terminals) supply the automatic transfer switch. The automatic transfer switch in turn supplies the UPS. Critical load distribution is as described above.
5. *Parallel 400-Hz single-CPU configuration:* Two or more 60- to 400-Hz frequency converters are normally connected in a redundant configuration to supply the critical load. There is no static switch or bypass breaker. Note that, on static converters, it is possible to use a 400-Hz motor-generator as a bypass source.
6. *Common UPS for single-mainframe computer site:* Two 60- to 400-Hz frequency converters are normally connected in a redun-

dant configuration supplying the mainframe computer, while a 60-Hz UPS supplies the peripherals.

7. *Alternative combination UPS for single-mainframe computer site:* A 60-Hz UPS supplies a critical load bus that, in turn, supplies the peripherals plus the input to a motor-generator set frequency converter (60 to 400 Hz).
8. *Combination UPS for multiple-mainframe computer site:* A utility source supplies a redundant 400-Hz UPS system. This paralleled system supplies a 400-Hz critical load distribution bus. Feeders from the 400-Hz distribution bus, equipped with line drop compensators (LDCs) to reactive voltage drop, supply computer mainframes. A utility source also supplies a parallel redundant 60-Hz UPS system. This system supplies the critical peripheral load.
9. *Remote redundant 400-Hz UPS:* A 60-Hz UPS and a downstream parallel redundant 400-Hz motor-generator frequency conversion system with paralleling and distribution switchgear and line drop compensators, which are all installed in the facility power equipment room with 60- and 400-Hz feeders distributed into the computer room.
10. *Point-of-use redundant 400-Hz UPS:* A 60-Hz UPS and a parallel redundant frequency conversion system as in item 9, except that the motor-generators are equipped with silencing enclosures and are installed in the computer room near the mainframes.
11. *Point-of-use 400-Hz UPS:* A 60-Hz UPS and a nonparalleled point-of-use static or rotary 400-Hz frequency converter installed in the computer room adjacent to each mainframe.
12. *Remote 400-Hz UPS:* A 60-Hz UPS and a separate parallel redundant 400-Hz UPS installed in the power equipment room, which is similar to item 8.
13. *Wiring:* For 400-Hz circuits, the reactance of circuit conductors may produce unacceptable voltage drops. Multiple conductor cables and use of conductors in parallel, if necessary, should be installed in accordance with the *NEC*, Article 310-4. Also, use of a nonmagnetic conduit will help in reducing voltage drop.

It should be noted that 400-Hz (actually 415-Hz) mainframe computers are rarely used today. Most mainframe computers are now 60 Hz.

NOTES

A large grid area for taking notes, consisting of a 20x20 grid of small squares. The grid is empty and occupies the majority of the page below the 'NOTES' header.

CHAPTER SIX

Lighting

6.0 MEASURING LIGHT AND ILLUMINATION TERMS

Definitions

Luminous intensity, I , is the solid angular flux density in a given direction measured in candlepower in American National Standards Institute (ANSI) units and candela (cd) in SI units. The candela and candlepower have the same magnitude. See Figure 6.1.

Lumen (lm) is the unit of luminous flux equal to the flux in a unit solid angle of 1 steradian (sr) from a uniform point source of 1 cd. On a unit sphere, an area of 1 ft^2 (or 1 m^2) will subtend an angle of 1 sr. Because the area of a unit sphere is $4 \times \pi$, a source of 1 candlepower (1 cd) produces 12.57 lm.

Illuminance (E) is the density of luminous flux *incident* on a surface in lumens per unit area. One lumen uniformly incident on 1 ft^2 of area produces an illuminance of one footcandle. The unit of measurement, therefore, is the footcandle (fc) in ANSI units. In SI units, the measurement is lux (lx), or lumens per square meter.

$$1 \text{ footcandle} = 10.764 \text{ lux}$$

$$\text{fc} = \text{lm}/\text{ft}^2$$

$$\text{fc} = \text{lm}/\text{m}^2$$

As a rule of thumb, 10 lx is taken as being approximately equal to 1 fc.

Luminance, L , is the luminous flux per unit of projected area (apparent) area and a unit solid angle *leaving* a surface, either reflected or transmitted. The unit is the footlambert (fL), in which $1 \text{ fL} = 1/\pi$ candelas per square foot. In SI units, it is candela per square meter. Luminance takes into account the reflectance and transmittance properties of materials and the direction in which they are viewed (the apparent area). Thus, 100 fc striking a surface with 50 percent reflectance would result in a luminance of 50 fL.

Another way to view illuminance is to say that a surface emitting, transmitting, or reflecting $1 \text{ lm}/\text{ft}^2$ in the direction being viewed has a

FIGURE 6.1 Relationship of light source, illumination, transmittance, and reflectance. (Source: GE Lighting Business Group)

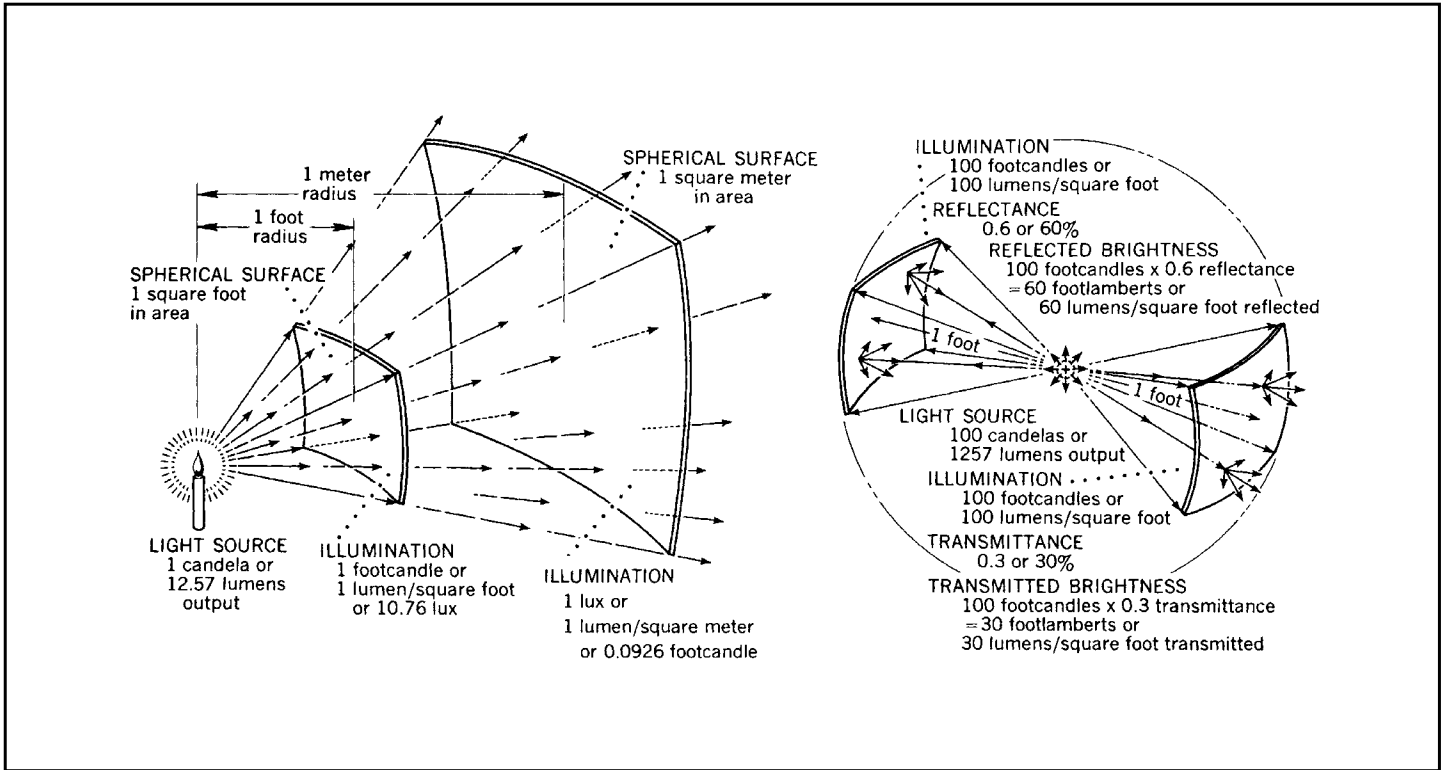

TABLE 6.1 Conversion Factors of Units of Illumination

Given	Multiply by	to obtain
Illuminance (E) in lux	0.0929	footcandles
Illuminance (E) in footcandles	10.764	lux
Luminance (L) in cd/sq. m	0.2919	footlamberts
Luminance (L) in footlamberts	3.4263	cd/sq. m
Intensity (I) candelas	1.0	candlepower

luminance of 1 fL. For more information about conversion factors of units of illumination, see Table 6.1.

Inverse Square Law

The illumination at a point on a surface when the surface is perpendicular to the direction of the source varies directly with the luminous intensity of the source and inversely with the square of the distance between the source and the point:

$$E = \frac{I}{d^2}$$

where: E = illumination in footcandles (or lux)
 I = luminous intensity in candlepower (or candela)
 d = distance in feet (or meters)

This equation assumes the source is a *point source*. Because a point source is only theoretical, the formula is applicable when the maximum dimension of the source is less than five times the distance to the point at which the illumination is being calculated.

The value for I at various angles can be obtained from the candlepower distribution curves or tables supplied by the manufacturer of the luminaire under consideration.

Cosine Law

The illumination of any surface varies as the cosine of the angle of incidence, θ , where the angle of incidence is the angle between the normal to the surface and the direction of the incident light. See Figure 6.2.

Combined with the equation just given, the formula becomes:

$$E = \frac{I}{d^2} \cos \theta$$

FIGURE 6.2 Cosine law of illumination.

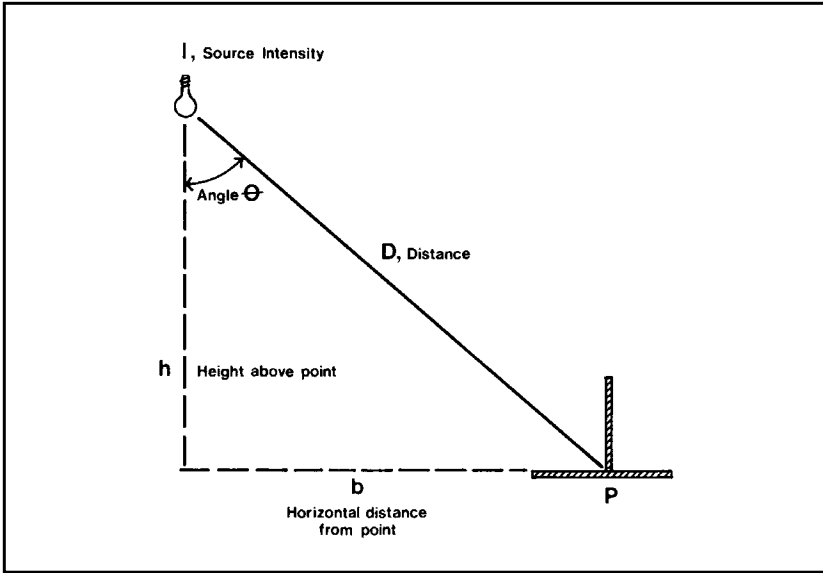

This is the illumination on the horizontal surface at point P. For illumination on a vertical surface at point P, the equation becomes:

$$E (v) = \frac{I}{d^2} \cos \theta$$

Because $\cos \theta = \frac{h}{d}$

and $\sin \theta = \frac{b}{d}$

the equations for horizontal and vertical illumination can be rewritten as follows:

$$E (h) = \frac{I}{h^2} \cos^3 \theta$$

$$E (v) = \frac{I}{b^2} \sin^3 \theta$$

Example: What is the vertical surface illumination on a wall 6 ft down from the ceiling that is illuminated by a downlight placed 3 ft from the wall? The candlepower distribution curve for the fixture indicates an intensity of 2550 fc at 25° from vertical.

The angle, θ , is $\arctan 3/6$, or 26.6° . Because this is very close to the reading at 25° , use $I = 2550$ fc. Thus:

$$E(v) = 2550/3^2 \sin^3 26.6^\circ$$

$$E(v) = 25 \text{ fc}$$

If the reflectance of the wall is 55 percent, the luminance, L , is 25×0.55 , or about 14 fL.

6.1 HOW TO SELECT THE RECOMMENDED ILLUMINANCE LEVEL

Different tasks under different conditions require different levels of illumination. The variables include the task itself, the age of the person performing the task, the reflectances of the room, and the demand for speed and/or accuracy in performing the task. The Illuminating Engineering Society of North America (IESNA) has established a range of illumination levels for various tasks, areas, and activities to take into account these variables.

To determine the required illumination level in footcandles (or lux), first determine the illuminance category for the task under consideration from Table 6.2. This table lists representative activities for common occupancies. For a detailed listing, refer to the complete table in the *IESNA Lighting Handbook*. Illuminance categories are given a letter

TABLE 6.2 Illuminance Categories for Selected Activities

Area/Activity	Illuminance Category
Auditoriums	
Assembly	C
Social activity	B
Banks	
General lobby area	C
Lobby writing area	D
Tellers' stations	E
Barber shops and beauty parlors	E
Conference rooms—conferring	D
For critical seeing, refer to individual task	
Drafting	
High contrast	E
Low contrast	F

TABLE 6.2 Illuminance Categories for Selected Activities (*Continued*)

Area/Activity	Illuminance Category
Educational facilities	
General classrooms (see Reading)	
Science laboratories	E
Lecture rooms—audience (see Reading)	
Lecture rooms—demonstrations	F
Cafeterias (see Food Service)	
Food service facilities	
Cashier	D
Cleaning	C
Dining	B
Kitchen	E
Hotels	
Bathrooms, for grooming	D
Bedrooms, for reading	D
Corridors, elevators, and stairs	C
Front desk	E
Lobby, general lighting	C
Libraries	
Reading areas (see Reading)	
Active stacks	D
Inactive stacks	B
Card files	E
Circulation desks	D
Merchandising spaces	
Dressing areas	D
Fitting areas	F
Wrapping and packaging	D
Sales transaction area	E
Offices	
Conference (see Conference rooms)	
General and private offices (see Reading)	
Lobbies, lounges, and reception areas	C
Mail sorting	E
Reading	
Copied tasks	
Microfiche reader	B
Photographs, moderate detail	E
Xerograph	D
Electronic data-processing tasks	
CRT screens	B
Impact printer, good ribbon	D
Keyboard reading	D
Machine rooms, active operations	D
Handwritten tasks	
# 3 pencil and softer leads	E
# 4 pencil and harder leads	F
Felt-tip pen	D
Chalkboards	E

TABLE 6.2 Illuminance Categories for Selected Activities (*Continued*)

Area/Activity	Illuminance Category
Printed tasks	
6 point type	E
8 and 10 point type	D
Maps	E
Typed originals	D
Telephone books	E
Residences	
General lighting	B
Dining	C
Grooming	D
Kitchen duties, critical seeing	E
Kitchen duties, non-critical	D
Reading, normal	D
Reading, prolonged	E
Service spaces	
Stairways, corridors	C
Elevators	C
Toilets and washrooms	C

Note: Refer to the *IES Lighting Handbook* for a detailed list of requirements for individual spaces and for industrial, transportation, and outdoor activities.

Source: Data extracted from *IES Lighting Handbook, 1981 Reference Volume*.

from A to I: A represents the lowest values for general lighting in non-critical areas, and I represents requirements for specialized and difficult visual tasks.

Table 6.3 gives the corresponding range of illuminances for each category.

With the illuminance category and the knowledge of the age of the occupant, the approximate (or assumed) surface reflectances, and the importance of the task, find which of the three values should be used by referring to Table 6.4. Note that the values in this table are in lux. For recommended footcandle levels, divide the values by 10.

The following caveats apply to selecting illumination levels and using them in lighting calculations:

1. All aspects of a quality design must be considered—control of glare, contrast ratios, color-rendering properties, and so on—not just raw illumination levels.
2. The values determined in the illumination categories are *maintained* values in the space, not initial values.
3. The values in categories A through C are average maintained illuminances and are most appropriate for lighting calculations using

TABLE 6.3 Illuminance Categories and Illuminance Values for Generic Types of Activities in Interiors

Type of Activity	Illuminance Category	Range of Illuminances (in footcandles)
<i>General lighting throughout space:</i>		
Public spaces with dark surroundings	A	2-3-5
Simple orientation for short temporary visits	B	5-7.5-10
Working spaces where visual tasks are only occasionally performed	C	10-15-20
<i>Illuminance on task:</i>		
Performance of visual tasks of high contrast or large size	D	20-30-50
Performance of visual tasks of medium contrast of small size	E	50-75-100
Performance of visual tasks of low contrast or very small size	F	100-150-200
<i>Illuminance on task, obtained by a combination of general and local (supplementary) lighting:</i>		
Performance of visual tasks of low contrast and very small size over a prolonged period	G	200-300-500
Performance of very prolonged and exacting visual tasks	H	500-750-1000
Performance of very special visual tasks of extremely low contrast and small size	I	1000-1500-2000

Source: IES Lighting Handbook, 1981 Reference Volume

the zonal cavity method, as described in the next section and for daylighting calculations. The values in categories D through I are illumination levels on the task. Point calculation methods, as described in the previous section, are more appropriate for these categories, although achieving the recommended illumination level may be accomplished with a combination of general and task lighting.

4. Special analysis and design is required for lighting for visual tasks in categories G through I.

6.2 ZONAL CAVITY METHOD OF CALCULATING ILLUMINATION

The number of luminaires required to light a space to a desired illumination level (footcandles) can be calculated knowing certain characteristics of the room and light source. The following method is the zonal cavity method of calculating illumination.

$$\frac{\text{Area}}{\text{luminaire}} = \frac{N \times \text{lumens per lamp} \times CU \times LLF}{\text{footcandles required (E)}}$$

TABLE 6.4 Illuminance Values, Maintained, in Lux, for a Combination of Illuminance Categories and User, Room, and Task Characteristics (for Illuminance in Footcandles, Divide by 10)

a. General Lighting Throughout Room								
Weighting Factors			Illuminance Categories					
Average of Occupants Ages	Average Room Surface Reflectance (per cent)		A	B	C			
Under 40	Over 70		20	50	100			
	30-70		20	50	100			
	Under 30		20	50	100			
40-55	Over 70		20	50	100			
	30-70		30	75	150			
	Under 30		50	100	200			
Over 55	Over 70		30	75	150			
	30-70		50	100	200			
	Under 30		50	100	200			

b. Illuminance on Task								
Weighting Factors			Illuminance Categories					
Average of Workers Ages	Demand for Speed and/or Accuracy*	Task Background Reflectance (per cent)	D	E	F	G**	H**	I**
Under 40	NI	Over 70	200	500	1000	2000	5000	10000
		30-70	200	500	1000	2000	5000	10000
		Under 30	300	750	1500	3000	7500	15000
	I	Over 70	200	500	1000	2000	5000	10000
		30-70	300	750	1500	3000	7500	15000
		Under 30	300	750	1500	3000	7500	15000
	C	Over 70	300	750	1500	3000	7500	15000
		30-70	300	750	1500	3000	7500	15000
		Under 30	300	750	1500	3000	7500	15000
40-55	NI	Over 70	200	500	1000	2000	5000	10000
		30-70	300	750	1500	3000	7500	15000
		Under 30	300	750	1500	3000	7500	15000
	I	Over 70	300	750	1500	3000	7500	15000
		30-70	300	750	1500	3000	7500	15000
		Under 30	300	750	1500	3000	7500	15000
	C	Over 70	300	750	1500	3000	7500	15000
		30-70	300	750	1500	3000	7500	15000
		Under 30	500	1000	2000	5000	10000	20000
Over 55	NI	Over 70	300	750	1500	3000	7500	15000
		30-70	300	750	1500	3000	7500	15000
		Under 30	300	750	1500	3000	7500	15000
	I	Over 70	300	750	1500	3000	7500	15000
		30-70	300	750	1500	3000	7500	15000
		Under 30	500	1000	2000	5000	10000	20000
	C	Over 70	300	750	1500	3000	7500	15000
		30-70	500	1000	2000	5000	10000	20000
		Under 30	500	1000	2000	5000	10000	20000

* NI = not important, I = important, and C = critical
 ** Obtained by a combination of general and supplementary lighting.

Source: IES Lighting Handbook, 1981 Reference Volume

where: N = number of lamps
 CU = coefficient of utilization
 LLF = light loss factor
 E = recommended illumination (maintained)

The formula can be rewritten to find the number of luminaires or to determine the maintained footcandle level.

$$\text{Number of luminaires} = \frac{\text{footcandles required} \times \text{area of room}}{N \times \text{lumens per lamp} \times CU \times LLF}$$

$$\text{Footcandles} = \frac{N \times \text{lumens per lamp} \times CU \times LLF}{\text{area per luminaire}}$$

The coefficient of utilization (CU) is a factor that reflects the fact that not all of the lumens produced by a luminaire reach the work surface. It depends on the particular light fixture used as well as the characteristics of the room in which it is placed, including the room size and the surface reflectances of the room. If you know the specific luminaire you want to use, obtain coefficient of utilization factors from the manufacturer and use those. They are usually included in product catalogs.

If you do not know specifically what fixture you will be selecting, you can use general coefficient of utilization tables based on luminaire types (see Table 6.5).

Light Loss Factor (LLF)

The light loss factor is a fraction that represents the amount of light that will be lost due to things such as dirt on lamps, reduction of light output of a lamp over time, and similar factors. The following items are the individual components of the LLF . The total LLF is calculated by multiplying all of the individual factors together.

Ambient temperature: For normal indoor temperatures, use 1. For air-handling luminaires, use 1.10.

Voltage: Use 1 for luminaire operation at rated temperature.

Luminaire surface depreciation: Over time, the various surfaces of a light fixture will change (some plastic lenses yellow, for example).

In the absence of data, use a value of 1.

Nonstandard components: Use of different components such as ballasts, louvers, and so on can affect light output. Use a value of 1 if no other information is available.

In the absence of other data, use a factor of 0.9 for the combination of the four factors just mentioned. This is usually adequate for most situations.

TABLE 6.5 Coefficients of Utilization







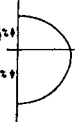

Typical Luminaire	Typical Intensity Distribution and Per Cent Lamp Lumens	pcc → pw →	80			70			50			30			10			0			
			50			30			10			50			30			10	0		
			Maint. Cat.	SC	RCR ↓	Coefficients of Utilization for 20 Per Cent Effective Floor Cavity Reflectance (ρ _{cc} = 20)															
 Pendant diffusing sphere with incandescent lamp	 35% ↑ 45% ↑	V	1.5	0	87	87	87	81	81	81	70	70	70	59	59	59	49	49	49	45	
				1	71	67	63	66	62	59	56	53	50	47	45	42	38	37	35	31	
				2	60	54	49	56	50	45	47	43	39	39	36	33	32	29	27	23	
				3	52	45	39	48	42	37	41	36	31	34	30	26	27	24	22	18	
				4	46	38	33	42	36	30	36	30	26	30	26	22	24	21	18	15	
				5	40	33	27	37	30	25	31	26	22	26	22	18	21	18	15	12	
				6	38	28	23	33	26	21	28	23	19	23	19	16	19	15	13	10	
				7	32	25	20	29	23	18	25	20	16	21	16	13	17	13	11	09	
				8	29	22	17	26	20	16	23	17	14	19	15	12	15	12	09	07	
				9	26	19	15	24	18	14	20	15	12	17	13	10	14	11	08	06	
10	23	17	13	22	16	12	19	14	10	16	12	09	13	09	07	05					
 Concentric ring unit with incandescent silvered-bowl lamp	 83% ↑ 3 1/2% ↑	II	N.A.	0	83	83	83	72	72	72	50	50	50	30	30	30	12	12	12	.03	
				1	72	69	66	62	60	57	43	42	40	26	25	25	10	10	10	.03	
				2	63	58	54	54	50	47	38	36	33	23	22	21	09	09	08	.02	
				3	55	49	45	48	43	39	33	30	28	20	19	17	08	08	07	.02	
				4	48	42	37	42	37	33	29	26	24	18	16	15	07	07	06	.02	
				5	43	36	32	37	32	28	26	23	20	16	14	13	06	06	05	.01	
				6	38	32	27	33	28	24	23	20	17	14	12	11	06	05	04	.01	
				7	34	28	23	30	24	21	21	17	15	13	11	09	05	04	04	.01	
				8	31	25	20	27	21	18	19	15	13	12	10	08	05	04	03	.01	
				9	28	22	18	24	19	16	17	14	11	10	09	07	04	03	03	.01	
10	25	20	16	22	17	14	16	12	10	10	08	06	04	03	03	.01					
 Porcelain-enamelled ventilated standard dome with incandescent lamp	 0% ↑ 83% ↑	IV	1.3	0	99	99	99	97	97	97	93	93	93	89	89	89	85	85	85	.83	
				1	88	85	82	86	83	81	83	80	78	79	78	76	77	75	73	.72	
				2	78	73	68	76	72	67	73	69	66	71	67	64	68	65	63	.61	
				3	69	62	57	67	61	57	65	60	56	63	58	55	61	57	54	.52	
				4	61	54	49	60	53	48	58	52	48	56	51	47	54	50	46	.45	
				5	54	47	41	53	46	41	51	45	41	50	44	40	48	43	40	.38	
				6	48	41	35	47	40	35	46	39	35	44	39	34	43	38	34	.32	
				7	43	35	30	42	35	30	41	34	30	39	34	30	38	33	29	.28	
				8	38	31	26	38	31	26	37	30	26	36	30	26	35	30	26	.24	
				9	35	28	23	34	27	23	33	27	23	32	27	23	31	26	22	.21	
10	31	25	20	31	24	20	30	24	20	29	24	20	29	24	20	.18					
 Prismatic square surface drum	 18 1/2% ↑ 60 1/2% ↑	V	1.3	0	89	89	89	85	85	85	77	77	77	70	70	70	63	63	63	.60	
				1	78	75	72	74	72	69	88	86	84	82	80	58	56	55	54	.51	
				2	69	65	61	66	62	58	61	57	54	56	53	50	51	49	47	.44	
				3	62	57	52	60	55	50	55	51	47	50	47	44	46	43	41	.39	
				4	56	50	46	54	49	44	50	45	42	46	42	39	42	39	37	.35	
				5	51	45	40	49	43	39	45	41	37	42	38	35	39	36	33	.31	
				6	46	40	36	45	39	35	42	37	33	39	35	31	36	32	30	.28	
				7	42	36	32	41	35	31	38	33	29	35	31	28	33	29	27	.25	
				8	38	32	28	37	32	28	35	30	26	32	28	25	30	27	24	.22	
				9	35	29	25	34	29	25	32	27	24	30	26	23	28	24	22	.20	
10	32	27	23	31	26	22	29	25	21	27	23	20	26	22	20	.18					
 R-40 flood without shielding	 0% ↑ 100% ↑	IV	0.8	0	1.19	1.19	1.19	1.16	1.16	1.16	1.11	1.11	1.11	1.06	1.06	1.06	1.02	1.02	1.02	.00	
				1	1.09	1.07	1.04	1.07	1.05	1.02	1.03	1.01	99	99	98	96	96	95	93	.92	
				2	1.01	97	93	99	95	92	96	93	90	93	90	88	90	88	86	.84	
				3	93	88	84	92	87	83	89	85	81	87	83	80	84	81	79	.77	
				4	87	81	76	85	80	75	83	78	75	81	77	74	79	76	73	.71	
				5	80	74	69	79	73	69	77	72	68	76	71	67	74	70	67	.65	
				6	74	68	63	73	67	63	72	66	62	70	66	62	69	65	61	.60	
				7	69	62	57	68	62	57	67	61	57	65	60	56	64	60	56	.55	
				8	64	57	53	63	57	52	62	56	52	61	56	52	60	55	52	.50	
				9	59	52	48	59	52	48	58	52	48	57	51	48	56	51	47	.46	
10	55	49	44	55	48	44	54	48	44	53	48	44	52	47	44	.42					
 R-40 flood with specular anodized reflector skirt, 45° cutoff	 0% ↑ 85% ↑	IV	0.7	0	1.01	1.01	1.01	99	99	99	94	94	94	90	90	90	87	87	87	.85	
				1	96	94	92	94	92	91	90	89	88	87	86	85	84	84	83	.82	
				2	91	88	86	90	87	85	87	85	83	84	83	82	82	81	80	.79	
				3	87	84	81	86	83	81	84	81	79	82	80	78	80	78	77	.76	
				4	83	80	77	82	79	77	81	78	76	79	77	75	78	76	74	.73	
				5	79	76	73	79	75	73	77	74	72	76	73	71	75	73	71	.70	
				6	76	73	70	76	72	70	75	72	69	74	71	69	73	70	68	.67	
				7	73	69	66	73	69	66	72	68	66	71	68	66	70	67	65	.64	
				8	70	66	63	70	66	63	69	65	63	68	65	63	67	65	63	.62	
				9	67	63	60	67	63	60	66	62	60	65	62	60	65	62	60	.59	
10	64	60	56	64	60	58	63	60	58	63	60	57	62	59	57	.56					

TABLE 6.5 Coefficients of Utilization (Continued)

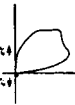
Typical Luminaire	Typical Intensity Distribution and Per Cent Lamp Lumens	pcc →	80			70			50			30			10			0							
			p _w →			50			30			10			50				30			10			0
			Maint. Cat.	SC	RCR ↓	Coefficients of Utilization for 20 Per Cent Effective Floor Cavity Reflectance (ρ _{FC} = 20)																			
 <p>EAR-38 lamp above 51 mm (2") diameter aperture (increase efficiency to 54 1/2% for 76 mm (3") diameter aperture)*</p>		IV	0.7	0	52	52	52	51	51	51	48	48	48	46	46	46	45	45	45	44					
				1	49	48	48	48	47	47	47	46	46	46	45	45	44	44	43	43	42				
				2	47	46	45	46	45	44	45	44	43	44	43	42	42	43	42	41	42	41			
				3	45	44	43	45	43	42	44	42	42	43	42	41	42	41	40	41	40	40			
				4	43	42	41	43	41	40	42	41	40	41	40	39	40	39	41	40	39	38			
				5	42	40	39	41	40	38	41	39	38	40	39	38	39	38	39	38	37	37			
				6	40	39	37	40	38	37	39	38	37	39	38	37	38	37	38	37	36	36			
				7	39	37	36	39	37	36	38	37	36	38	37	36	37	36	37	36	35	35			
				8	37	36	34	37	35	34	37	35	34	36	35	34	35	34	35	34	33	33			
				9	36	34	33	36	34	33	35	34	33	35	34	33	34	33	34	33	32	32			
				10	35	33	32	35	33	32	34	33	32	34	33	32	33	32	34	32	31	31			
 <p>Medium distribution unit with lens plate and inside frost lamp</p>		V	1.0	0	65	65	65	63	63	63	60	60	60	58	58	58	55	55	55	54					
				1	60	58	57	58	57	56	56	55	54	54	53	52	52	52	51	51	50				
				2	55	53	51	54	52	50	52	50	49	51	49	48	49	48	47	47	46				
				3	51	48	46	50	47	45	49	46	44	47	45	44	46	44	44	43	43				
				4	47	44	41	47	44	41	45	43	41	44	42	40	43	41	41	40	39				
				5	44	40	38	43	40	38	42	39	37	41	39	37	40	38	37	36	36				
				6	41	37	35	40	37	35	39	36	34	39	36	34	38	36	34	34	33				
				7	38	34	32	37	34	32	37	34	31	36	33	31	35	33	31	31	30				
				8	35	32	29	35	31	29	34	31	29	34	31	29	33	30	29	28	28				
				9	33	29	27	32	29	27	32	29	26	31	28	26	31	28	26	26	25				
				10	30	27	25	30	27	24	30	27	24	29	26	24	29	26	24	24	23				
 <p>Recessed baffled downlight, 140 mm (5 1/2") diameter aperture—150-PAR/FL lamp</p>		IV	0.5	0	82	82	82	80	80	80	78	78	76	73	73	73	70	70	70	69					
				1	78	77	76	77	76	75	74	74	73	72	71	71	69	69	68	68	68				
				2	76	74	73	75	73	72	73	71	70	71	70	69	69	68	67	67	67				
				3	74	72	70	73	71	70	71	70	69	70	69	68	68	67	67	66	66				
				4	72	70	68	71	69	68	70	68	67	69	67	66	67	66	65	65	64				
				5	70	68	66	69	67	66	68	67	65	67	66	65	66	65	64	64	63				
				6	69	66	65	68	66	65	67	66	64	67	65	64	66	65	64	63	63				
				7	67	65	63	67	65	63	66	64	63	65	64	63	65	64	62	62	62				
				8	66	64	62	65	63	62	65	63	62	64	63	62	64	62	61	61	61				
				9	65	63	61	64	62	61	64	62	61	63	62	61	63	62	61	60	60				
				10	63	61	60	63	61	60	63	61	60	62	61	60	62	61	60	59	59				
 <p>Recessed baffled downlight, 140 mm (5 1/2") diameter aperture—75ER30 lamp</p>		IV	0.5	0	1.01	1.01	1.01	99	99	99	95	95	95	91	91	91	87	87	87	85					
				1	97	95	94	95	94	92	92	91	90	88	88	87	86	85	84	83	83				
				2	93	91	89	91	89	88	89	87	86	86	85	84	84	83	82	81	81				
				3	90	87	85	89	86	84	87	85	83	85	83	82	83	82	81	79	79				
				4	87	84	82	86	83	81	84	82	80	83	81	79	81	80	79	78	78				
				5	84	81	79	83	80	78	82	79	78	81	79	77	80	78	76	75	75				
				6	82	79	76	81	78	76	80	78	76	79	77	75	78	76	75	74	74				
				7	79	76	74	79	76	74	78	75	73	77	75	73	76	74	73	72	72				
				8	77	74	72	77	74	72	76	73	71	75	73	71	75	72	71	70	70				
				9	75	72	70	75	72	70	74	71	69	73	71	69	73	71	69	68	68				
				10	73	70	68	73	70	68	72	69	68	72	69	67	71	69	67	67	67				
 <p>Wide distribution unit with lens plate and inside frost lamp</p>		V	1.4	0	83	83	83	82	82	82	59	59	59	57	57	57	54	54	54	53					
				1	58	56	54	57	55	54	54	53	52	52	51	50	50	50	49	48	48				
				2	53	50	48	52	49	47	50	48	46	48	47	45	47	45	44	44	43				
				3	48	45	42	47	44	42	46	43	41	44	42	40	43	41	40	39	39				
				4	44	40	37	43	40	37	42	39	37	41	38	36	40	37	36	35	35				
				5	40	38	33	39	36	33	38	35	33	37	35	32	36	34	32	31	31				
				6	36	32	30	36	32	29	35	32	29	34	31	29	33	31	29	28	28				
				7	33	29	26	33	29	26	32	28	26	31	28	26	31	28	26	25	25				
				8	30	26	23	30	26	23	29	26	23	28	25	23	28	25	23	22	22				
				9	27	23	21	27	23	21	26	23	21	26	23	20	25	22	20	19	19				
				10	25	21	18	25	21	18	24	21	18	24	20	18	23	20	18	17	17				
 <p>Recessed unit with dropped diffusing glass</p>		V	1.3	0	62	62	62	60	60	60	57	57	57	54	54	54	52	52	52	51					
				1	53	51	48	52	49	47	49	47	46	47	45	44	45	43	42	41	41				
				2	46	42	39	45	42	39	43	40	38	41	39	36	39	37	35	34	34				
				3	40	36	33	40	35	32	38	34	31	36	33	31	35	32	30	29	29				
				4	36	31	28	35	31	28	34	30	27	32	29	26	31	28	26	25	25				
				5	32	27	24	31	27	24	30	26	23	29	25	23	28	25	22	21	21				
				6	29	24	20	28	24	20	27	23	20	26	22	20	25	22	19	18	18				
				7	26	21	18	25	21	18	24	20	17	23	20	17	22	19	17	16	16				
				8	23	19	16	23	18	15	22	18	15	21	18	15	20	17	15	14	14				
				9	21	17	14	21	16	14	20	16	13	19	16	13	19	15	13	12	12				
				10	19	15	12	19	15	12	18	14	12	18	14	12	17	14	12	11	11				

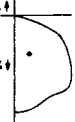
* Also, reflector downlight with baffles and inside frosted lamp.

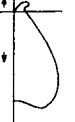
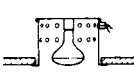
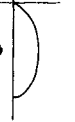
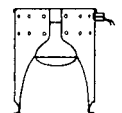
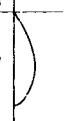
TABLE 6.5 Coefficients of Utilization (Continued)

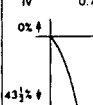
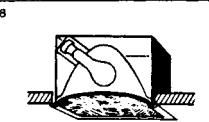
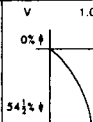
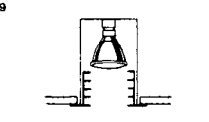
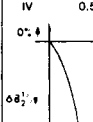
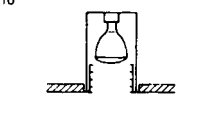
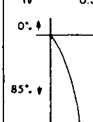
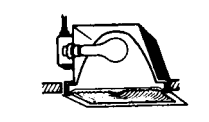
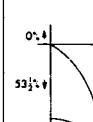
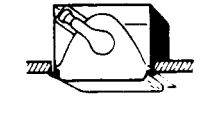
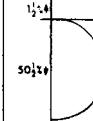

Typical Luminaire	Typical Intensity Distribution and Per Cent Lamp Lumens	R _{cc} →	80		70		50		30		10		0										
			ρ _w →		50 30 10		50 30 10		50 30 10		50 30 10		0										
			Main: Cat.	SC	RCR ↓	Coefficients of Utilization for 20 Per Cent Effective Floor Cavity Reflectance (ρ _{rc} = 20)																	
 <p>150 mm × 150 mm (6" × 6") cell parabolic wedge louver (multiply by 1.1 for 250 × 250 mm (10 × 10") cells)</p>		IV	1.5/1.2	0	.69	.69	.69	.67	.67	.67	.64	.64	.64	.62	.62	.62	.59	.59	.59	.58			
				1	.63	.61	.59	.62	.60	.58	.59	.58	.57	.57	.56	.55	.55	.54	.54	.51	.49	.48	.47
				2	.57	.54	.52	.56	.53	.51	.54	.52	.50	.52	.50	.49	.48	.45	.43	.46	.44	.42	.41
				3	.52	.48	.45	.51	.47	.45	.49	.46	.44	.46	.45	.43	.43	.40	.38	.42	.40	.38	.36
				4	.47	.42	.39	.46	.42	.39	.44	.41	.38	.43	.40	.38	.35	.33	.38	.35	.33	.32	.31
				5	.42	.37	.34	.41	.37	.34	.40	.36	.34	.39	.36	.33	.32	.29	.34	.31	.29	.28	.24
				6	.38	.33	.30	.37	.33	.30	.36	.32	.29	.35	.32	.29	.28	.25	.31	.28	.24	.22	.21
				7	.34	.29	.26	.33	.29	.26	.32	.29	.26	.32	.28	.26	.25	.22	.29	.25	.21	.19	.18
				8	.30	.26	.22	.30	.25	.22	.29	.25	.22	.28	.25	.22	.21	.19	.25	.21	.19	.18	.16
				9	.27	.22	.19	.27	.22	.19	.26	.22	.19	.25	.22	.19	.18	.17	.22	.19	.17	.16	.15
10	.24	.20	.17	.24	.20	.17	.23	.19	.17	.23	.19	.17	.16	.15	.20	.17	.16	.15	.14				
 <p>2 lamp, surface mounted, bare lamp unit—Photometry with 460 mm (18") wide panel above luminaire (lamps on 150 mm (6") centers)</p>		I	1.3	0	1.02	1.02	1.02	.99	.99	.99	.92	.92	.92	.86	.86	.86	.81	.81	.81	.78			
				1	.86	.82	.78	.83	.79	.75	.78	.74	.71	.73	.70	.67	.68	.66	.64	.61	.61	.61	.61
				2	.74	.67	.61	.71	.65	.60	.66	.61	.57	.62	.58	.54	.58	.55	.52	.49	.49	.48	.47
				3	.64	.56	.50	.62	.55	.49	.58	.52	.47	.54	.49	.45	.51	.47	.43	.41	.41	.40	.38
				4	.56	.48	.42	.55	.47	.41	.51	.45	.39	.48	.42	.38	.45	.40	.36	.34	.34	.33	.32
				5	.49	.41	.35	.48	.40	.34	.45	.38	.33	.42	.36	.32	.39	.34	.30	.28	.28	.27	.25
				6	.44	.36	.30	.43	.35	.29	.40	.33	.28	.38	.32	.27	.35	.30	.26	.24	.24	.23	.21
				7	.39	.31	.25	.38	.30	.25	.36	.29	.24	.34	.28	.23	.32	.27	.23	.21	.21	.20	.18
				8	.35	.27	.22	.34	.27	.22	.32	.26	.21	.30	.24	.20	.29	.23	.19	.18	.18	.17	.15
				9	.32	.24	.19	.31	.23	.18	.29	.22	.18	.27	.21	.17	.26	.20	.17	.15	.15	.14	.13
10	.29	.21	.17	.28	.21	.16	.26	.20	.16	.25	.19	.15	.23	.18	.15	.13	.13	.12	.11				
 <p>Luminous bottom suspended unit with extra-high output lamp</p>		VI	N.A.	0	.77	.77	.77	.68	.68	.68	.50	.50	.50	.34	.34	.34	.19	.19	.19	.12			
				1	.67	.64	.62	.59	.57	.54	.48	.42	.41	.30	.29	.28	.17	.16	.16	.11	.11	.10	.09
				2	.59	.54	.50	.52	.48	.45	.38	.36	.34	.26	.25	.23	.15	.14	.13	.09	.09	.08	.07
				3	.51	.46	.42	.45	.41	.37	.34	.31	.28	.23	.21	.20	.13	.12	.12	.07	.07	.06	.06
				4	.45	.40	.35	.40	.35	.31	.30	.27	.24	.20	.18	.17	.12	.11	.11	.06	.06	.05	.05
				5	.40	.34	.30	.35	.30	.27	.26	.23	.20	.18	.16	.14	.10	.09	.08	.07	.07	.06	.05
				6	.36	.30	.26	.32	.27	.23	.24	.20	.18	.16	.14	.12	.09	.08	.07	.06	.06	.05	.04
				7	.32	.26	.22	.28	.23	.20	.21	.18	.15	.15	.12	.11	.08	.07	.06	.06	.05	.04	.03
				8	.29	.23	.19	.25	.21	.17	.19	.16	.13	.13	.11	.09	.08	.06	.06	.05	.04	.03	.03
				9	.26	.20	.17	.23	.18	.15	.17	.14	.12	.12	.10	.08	.07	.06	.05	.04	.03	.03	.02
10	.24	.18	.15	.21	.16	.13	.16	.12	.10	.11	.09	.07	.06	.05	.04	.03	.03	.02	.02				
 <p>Prismatic bottom and sides, open top, 4 lamp suspended unit—see note 7</p>		VI	1.4/1.2	0	.91	.91	.91	.85	.85	.85	.74	.74	.74	.64	.64	.64	.54	.54	.54	.50			
				1	.80	.77	.74	.75	.73	.70	.66	.64	.62	.57	.56	.54	.49	.48	.47	.43	.43	.42	.40
				2	.71	.66	.62	.67	.63	.59	.59	.56	.53	.51	.49	.47	.44	.43	.41	.38	.38	.37	.35
				3	.63	.58	.53	.60	.55	.50	.53	.49	.45	.46	.43	.41	.40	.38	.36	.33	.33	.32	.30
				4	.57	.50	.45	.53	.48	.43	.47	.43	.39	.41	.38	.35	.36	.34	.32	.29	.29	.28	.25
				5	.50	.44	.39	.48	.42	.37	.42	.38	.34	.37	.34	.31	.33	.30	.28	.25	.25	.24	.21
				6	.45	.39	.34	.43	.37	.33	.38	.33	.30	.34	.30	.27	.30	.27	.24	.22	.22	.21	.19
				7	.41	.34	.30	.39	.33	.28	.34	.30	.26	.30	.27	.24	.27	.24	.21	.19	.19	.18	.16
				8	.37	.30	.26	.35	.29	.25	.31	.26	.23	.27	.24	.21	.24	.21	.18	.16	.16	.15	.14
				9	.33	.27	.22	.31	.26	.22	.28	.23	.20	.25	.21	.18	.22	.19	.16	.14	.14	.13	.12
10	.30	.24	.20	.28	.23	.19	.25	.21	.18	.23	.19	.16	.20	.17	.14	.13	.13	.12	.11				
 <p>2 lamp prismatic wraparound—see note 7</p>		V	1.5/1.2	0	.81	.81	.81	.78	.78	.78	.72	.72	.72	.66	.66	.66	.61	.61	.61	.59			
				1	.71	.69	.66	.69	.66	.64	.64	.62	.60	.59	.58	.56	.55	.54	.53	.50	.50	.49	.48
				2	.64	.59	.56	.61	.58	.54	.57	.54	.51	.53	.51	.49	.49	.48	.46	.44	.44	.43	.42
				3	.57	.52	.48	.55	.50	.47	.51	.48	.45	.48	.45	.42	.45	.42	.40	.38	.38	.37	.35
				4	.51	.46	.41	.49	.44	.41	.46	.42	.39	.43	.40	.37	.41	.38	.35	.34	.34	.33	.31
				5	.46	.40	.36	.44	.39	.35	.41	.37	.34	.39	.35	.32	.37	.33	.31	.29	.29	.28	.26
				6	.41	.35	.31	.40	.35	.31	.38	.33	.30	.35	.31	.28	.33	.30	.27	.26	.26	.25	.23
				7	.37	.31	.27	.36	.31	.27	.34	.29	.26	.32	.28	.25	.30	.27	.24	.23	.23	.22	.20
				8	.33	.28	.24	.32	.27	.23	.30	.26	.22	.29	.25	.22	.27	.24	.21	.19	.19	.18	.16
				9	.30	.24	.20	.29	.24	.20	.27	.23	.19	.26	.22	.19	.24	.21	.18	.17	.17	.16	.14
10	.27	.22	.18	.26	.21	.18	.25	.20	.17	.23	.19	.16	.22	.18	.16	.15	.15	.14	.13				
 <p>2 lamp prismatic wraparound—see note 7</p>		V	1.2	0	.82	.82	.82	.77	.77	.77	.69	.69	.69	.61	.61	.61	.53	.53	.53	.50			
				1	.71	.68	.65	.67	.65	.62	.63	.60	.58	.56	.53	.51	.50	.47	.45	.44	.44	.43	.41
				2	.63	.58	.54	.59	.55	.52	.53	.50	.47	.47	.45	.42	.42	.40	.38	.35	.35	.34	.33
				3	.56	.50	.46	.53	.48	.44	.47	.44	.40	.42	.39	.37	.38	.35	.33	.31	.31	.30	.28
				4	.50	.44	.40	.48	.42	.38	.43	.39	.35	.38	.35	.32	.34	.32	.29	.27	.27	.26	.24
				5	.45	.39	.34	.43	.37	.33	.38	.34	.31	.35	.31	.28	.31	.28	.26	.24	.24	.23	.21
				6	.41	.35	.30	.39	.33	.29	.35	.30	.27	.32	.28	.25	.28	.25	.23	.21	.21	.20	.18
				7	.37	.31	.27	.35	.30	.26	.32	.27	.24	.29	.25	.22	.26	.23	.20	.19	.19	.18	.16
				8	.33	.27	.23	.32	.26	.23	.29	.24	.21	.26	.22	.20	.23	.20	.18	.16	.16	.15	.14
				9	.30	.24	.20	.29	.23	.20	.26	.22	.19	.24	.20	.17	.21	.18	.16	.14	.14	.13	.12
10	.27	.22	.18	.26	.21	.18	.24	.19	.16	.22	.18	.15	.19	.16	.14	.13	.13	.12	.11				

TABLE 6.5 Coefficients of Utilization (Continued)



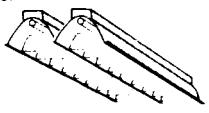
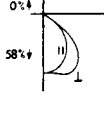
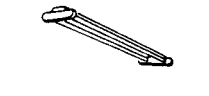
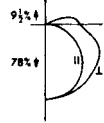
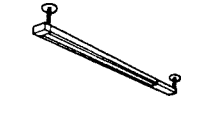
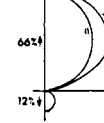
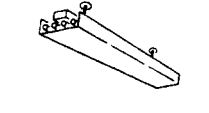
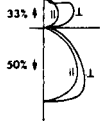

Typical Luminaire	Typical Intensity Distribution and Per Cent Lamp Lumens	$\rho_{cc} \rightarrow$	80		70			50			30			10			0					
			$\rho_w \rightarrow$		50	30	10	50	30	10	50	30	10	50	30	10	0					
			Maint. Cat.	SC	RCR ↓	Coefficients of Utilization for 20 Per Cent Effective Floor Cavity Reflectance ($\rho_{cc} = 20$)																
 2 lamp diffuse wraparound—see note 7	 85° ↓ 37½° ↑	V	1.3	0	52	52	52	50	50	50	46	46	46	43	43	43	39	39	39	38		
				1	45	43	41	43	41	39	40	38	37	36	35	34	34	33	32	30		
				2	39	35	33	37	34	32	34	32	30	32	30	28	26	24	29	28	26	25
				3	34	30	27	33	29	26	30	27	25	28	26	24	26	24	22	21	19	18
				4	30	26	23	29	25	22	27	24	21	25	22	20	23	21	19	17	15	14
				5	26	22	19	25	21	19	23	20	18	22	19	17	20	18	16	15	13	12
				6	23	19	16	23	19	16	21	18	15	19	17	14	18	16	14	13	11	10
				7	21	17	14	20	16	14	19	16	13	18	15	13	16	14	12	11	9	8
				8	19	15	12	18	14	12	17	14	11	16	13	11	15	12	10	9	7	6
				9	17	13	10	16	13	10	15	12	10	14	11	9	13	11	9	8	6	5
				10	15	12	9	15	11	9	14	11	9	13	10	8	12	10	8	7	5	4
 4 lamp, 610 mm (2') wide troffer with 45° plastic louver—see note 7	 0° ↓ 50° ↑	IV	1.0	0	60	60	60	58	58	58	56	56	56	53	53	53	51	51	51	50		
				1	54	52	50	52	51	49	50	49	48	48	47	46	47	46	45	44	43	42
				2	48	45	43	47	44	42	45	43	41	44	42	40	42	41	39	39	37	36
				3	43	40	37	42	39	37	41	38	36	40	37	36	39	37	35	34	33	32
				4	39	35	32	38	35	32	37	34	32	36	33	31	35	33	31	30	29	28
				5	35	31	28	35	31	28	34	30	28	33	30	28	32	29	27	26	25	24
				6	32	28	25	32	28	25	31	27	25	30	27	25	29	26	24	23	22	21
				7	29	25	22	29	25	22	28	25	22	27	24	22	26	24	22	21	20	19
				8	26	22	20	26	22	20	25	22	20	25	22	19	24	21	19	18	17	16
				9	24	20	17	24	20	17	23	20	17	23	19	17	22	19	17	16	15	14
				10	22	18	16	22	18	16	21	18	16	21	18	15	20	17	15	14	13	12
 4 lamp, 610 mm (2') wide troffer with 45° white metal louver—see note 7	 0° ↓ 46° ↑	IV	0.9	0	55	55	55	54	54	54	51	51	51	49	49	49	47	47	47	46		
				1	50	48	47	49	47	46	47	46	45	45	44	43	43	43	43	42	41	40
				2	45	43	41	44	42	40	43	41	39	41	40	38	40	39	37	37	36	35
				3	41	38	36	40	38	35	39	37	35	38	36	34	37	35	34	33	32	31
				4	37	34	32	37	34	31	36	33	31	35	32	31	34	32	30	29	28	27
				5	34	30	28	33	30	28	32	30	27	32	29	27	31	29	27	26	25	24
				6	31	28	25	31	27	25	30	27	25	29	27	25	29	26	24	23	22	21
				7	29	25	23	28	25	23	28	25	22	27	24	22	26	24	22	21	20	19
				8	26	23	20	26	23	20	25	22	20	25	22	19	24	21	19	18	17	16
				9	24	20	18	24	20	18	23	20	18	23	20	18	22	20	18	17	16	15
				10	22	19	16	22	19	16	21	18	16	21	18	16	20	18	16	15	14	13
 Fluorescent unit with dropped diffuser, 4 lamp 610 mm (2') wide—see note 7	 1% ↓ 60½° ↑	V	1.2	0	73	73	73	71	71	71	68	68	68	65	65	65	62	62	62	60		
				1	64	61	59	62	60	58	60	58	56	57	56	54	55	54	53	52	51	49
				2	56	52	49	55	51	48	52	49	47	50	48	46	48	46	44	43	42	41
				3	50	45	41	49	44	41	47	43	40	45	42	39	43	41	38	37	36	35
				4	44	39	35	43	38	35	42	37	34	40	36	33	39	36	33	32	31	30
				5	39	34	30	38	33	29	37	32	29	36	32	29	34	31	28	27	26	25
				6	35	30	26	34	29	25	33	29	25	32	28	25	31	27	25	24	23	22
				7	31	26	22	31	26	22	30	25	22	29	25	22	28	24	22	21	20	19
				8	28	23	19	28	23	19	27	22	19	26	22	18	25	21	18	17	16	15
				9	25	20	17	25	20	17	24	20	17	23	19	16	23	19	16	15	14	13
				10	23	18	15	23	18	15	22	18	15	21	17	15	21	17	14	13	12	11
 Fluorescent unit with flat bottom diffuser, 4 lamp 610 mm (2') wide—see note 7	 0° ↓ 57½° ↑	V	1.2	0	69	69	69	67	67	67	64	64	64	61	61	61	59	59	59	58		
				1	61	58	56	59	57	56	57	55	54	55	53	52	53	52	51	49	48	47
				2	53	50	47	52	49	46	50	48	45	49	46	44	47	45	43	42	41	40
				3	47	43	40	47	42	39	45	41	38	43	40	38	42	39	37	36	35	34
				4	42	37	34	41	37	33	40	36	33	39	35	33	37	35	32	31	30	29
				5	37	32	29	37	32	28	35	31	28	34	31	28	33	30	27	26	25	24
				6	33	28	25	33	28	25	32	28	24	31	27	24	30	27	24	23	22	21
				7	30	25	22	30	25	21	29	24	21	28	24	21	27	24	21	20	19	18
				8	27	22	19	27	22	19	26	22	18	25	21	18	24	21	18	17	16	15
				9	24	19	16	24	19	16	23	19	16	23	19	16	22	19	16	15	14	13
				10	22	17	14	22	17	14	21	17	14	21	17	14	20	17	14	13	12	11
 Fluorescent unit with flat prismatic lens, 4 lamp 610 mm (2') wide—see note 7	 0 ↓ 63° ↑	V	1.4 : 1.2	0	75	75	75	73	73	73	70	70	70	67	67	67	64	64	64	63		
				1	67	65	63	66	64	62	63	62	60	61	60	58	59	58	57	55	54	53
				2	60	57	54	59	56	53	57	54	52	55	53	51	53	51	50	49	48	47
				3	54	50	47	53	49	46	52	48	45	50	47	45	48	46	44	43	42	41
				4	49	44	40	48	44	40	47	43	40	45	42	39	44	41	39	37	36	35
				5	44	39	35	43	38	35	42	38	34	41	37	34	40	36	34	33	32	31
				6	40	34	31	39	34	31	38	34	30	37	33	30	36	32	30	29	28	27
				7	36	30	27	35	30	27	34	30	27	33	29	26	32	29	26	25	24	23
				8	32	27	23	32	27	23	31	26	23	30	26	23	29	26	23	22	21	20
				9	29	24	20	28	23	20	28	23	20	27	23	20	26	23	20	19	18	17
				10	26	21	18	26	21	18	25	21	18	24	20	18	24	20	18	17	16	15

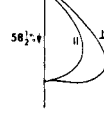
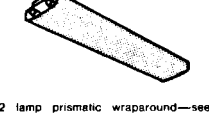
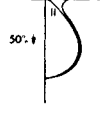
TABLE 6.5 Coefficients of Utilization (Continued)



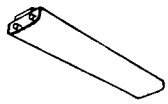
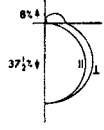
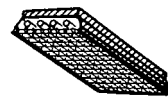
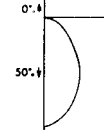
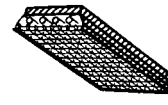
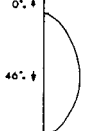
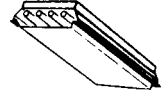
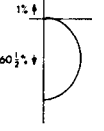

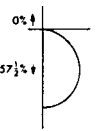

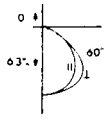
Typical Luminaire	Typical Intensity Distribution and Per Cent Lamp Lumens	$\mu_{CL} \rightarrow$		80			70			50			30			10			0				
				$\mu_{hw} \rightarrow$			$\mu_{hw} \rightarrow$			$\mu_{hw} \rightarrow$			$\mu_{hw} \rightarrow$			$\mu_{hw} \rightarrow$			$\mu_{hw} \rightarrow$				
		Maint. Cat.	SC	RCR ↓	Coefficients of Utilization for 20 Per Cent Effective Floor Cavity Reflectance ($\rho_{eff} = 20$)																		
 <p>4 lamp, 610 mm (2') wide unit with sharp cutoff (high angle—low luminance) flat prismatic lens—see note 7</p>		V	1 4/1 3	0	78	78	78	76	76	76	73	73	73	70	70	70	67	67	67	66	66	66	
		1	71	69	67	70	68	66	67	65	64	64	63	62	62	61	60	59	57	55	57	56	55
		2	64	61	58	63	60	58	61	59	58	59	57	55	57	55	54	55	54	53	54	53	53
		3	58	54	51	58	54	51	56	52	50	54	51	49	52	50	48	47	45	43	47	45	43
		4	53	48	45	52	48	44	51	47	44	49	46	43	48	45	43	44	43	42	43	42	42
		5	48	43	39	47	42	39	46	42	39	45	41	38	43	40	38	37	36	35	37	36	35
		6	43	38	35	43	38	34	42	37	34	40	37	34	40	37	34	38	36	34	38	36	34
		7	39	34	30	38	34	30	38	33	30	37	33	30	36	32	30	36	32	30	36	32	30
		8	35	30	26	35	30	26	34	29	26	33	29	26	33	29	26	32	29	26	32	29	26
		9	31	26	23	31	26	23	30	26	23	30	26	23	30	26	23	29	25	23	29	25	23
10	28	24	20	28	23	20	28	23	20	27	23	20	27	23	20	26	23	20	26	23	20		
 <p>Bilateral batwing distribution—lowered fluorescent unit</p>		IV	N A	0	71	71	71	70	70	70	66	66	66	64	64	64	61	61	61	60	60	60	
		1	65	63	61	63	62	60	61	59	58	59	57	56	57	56	55	56	55	54	55	54	54
		2	59	55	53	58	55	52	55	53	51	54	52	50	52	50	49	49	47	45	49	47	45
		3	53	49	46	52	48	45	50	47	45	49	46	44	47	45	43	47	45	43	46	44	42
		4	47	43	40	47	43	40	45	42	39	44	41	39	43	40	38	41	39	37	41	39	37
		5	42	38	34	42	37	34	41	37	34	40	36	34	39	36	34	38	36	34	38	36	34
		6	38	33	30	38	33	30	37	33	30	36	32	29	35	32	29	35	32	29	34	32	29
		7	34	29	26	33	29	26	33	28	25	32	28	25	31	28	25	31	28	25	31	28	25
		8	30	25	22	30	25	22	29	25	22	28	24	22	28	24	22	27	24	21	27	24	21
		9	27	22	18	26	22	18	26	21	18	25	21	18	25	21	18	24	21	18	24	21	18
10	24	19	16	24	19	16	23	19	16	22	19	16	22	18	16	22	18	16	21	18	15		
 <p>Bilateral batwing distribution—4 lamp, 610 mm (2') wide fluorescent unit with flat prismatic lens and overlay—see note 7</p>		V	N A	0	57	57	57	56	56	56	53	53	53	51	51	51	49	49	49	48	48	48	
		1	50	48	47	49	47	46	47	46	44	45	44	43	44	43	42	43	42	41	42	41	41
		2	44	41	38	43	40	38	41	39	37	40	38	36	38	37	35	38	37	35	37	35	34
		3	39	35	32	38	34	31	37	33	31	35	33	30	34	32	30	34	32	30	33	31	29
		4	34	30	27	33	29	26	32	29	26	31	28	26	30	27	25	30	27	25	29	27	25
		5	30	25	22	29	25	22	28	24	22	27	24	21	26	23	21	26	23	21	25	23	21
		6	26	22	19	26	22	18	25	21	18	24	21	18	23	20	18	23	20	18	22	19	17
		7	23	19	16	23	19	16	22	18	16	21	18	15	21	18	15	21	18	15	20	18	15
		8	21	16	13	20	16	13	19	16	13	19	15	13	18	15	13	18	15	13	18	15	13
		9	18	14	11	18	14	11	17	14	11	17	13	11	17	13	11	16	13	11	16	13	11
10	16	12	09	16	12	09	16	12	09	15	12	09	15	12	09	15	12	09	14	11	08		
 <p>Bilateral batwing distribution—one lamp, surface mounted fluorescent with prismatic wraparound lens</p>		V	N A	0	87	87	87	84	84	84	77	77	77	72	72	72	66	66	66	64	64	64	
		1	76	73	70	73	70	67	67	65	63	63	61	59	58	57	55	57	55	53	56	54	53
		2	66	61	57	64	59	56	59	56	52	55	52	49	51	49	47	49	47	44	48	46	44
		3	59	53	48	56	51	47	53	48	44	49	45	42	46	43	40	46	43	40	45	42	38
		4	52	45	40	50	44	40	47	42	38	44	39	36	41	37	34	41	37	34	40	37	34
		5	46	39	34	44	38	33	41	36	32	38	34	31	36	32	29	36	32	29	35	32	29
		6	41	34	29	39	33	29	37	31	27	34	30	26	32	28	25	32	28	25	31	28	25
		7	36	30	25	35	29	24	33	27	23	31	26	23	30	26	23	29	25	22	29	25	22
		8	32	26	21	31	25	21	29	24	20	27	23	19	26	21	18	26	21	18	25	21	17
		9	29	22	18	28	22	18	26	21	17	24	20	16	23	19	15	23	19	15	22	18	14
10	26	20	16	25	19	15	23	18	15	22	17	14	21	16	13	21	16	13	20	16	12		
 <p>Radial batwing distribution—4 lamp, 610 mm (2') wide fluorescent unit with flat prismatic lens—see note 7</p>		V	1.7	0	71	71	71	69	69	69	66	66	66	63	63	63	61	61	61	60	60	60	
		1	62	60	58	61	59	57	59	57	55	56	55	53	54	53	52	53	52	51	52	51	51
		2	55	51	47	53	50	47	51	48	46	49	47	45	48	45	44	47	45	44	46	44	42
		3	48	43	39	47	43	39	45	41	38	44	40	38	42	39	37	41	38	36	40	37	36
		4	42	37	33	41	37	33	40	36	32	39	35	32	37	34	31	37	34	31	36	33	31
		5	37	32	27	36	31	27	35	30	27	34	30	27	33	29	26	33	29	26	32	29	26
		6	33	27	23	32	27	23	31	26	23	30	26	23	29	25	23	29	25	23	28	25	23
		7	29	24	20	29	24	20	28	23	20	27	23	20	27	23	20	26	22	19	26	22	19
		8	26	21	17	25	20	17	25	20	17	24	20	17	23	19	16	23	19	16	22	18	15
		9	23	18	14	23	18	14	22	17	14	21	17	14	21	17	14	21	17	14	20	17	14
10	21	16	12	20	16	12	20	15	12	19	15	12	19	15	12	19	15	12	18	15	12		
 <p>2 lamp fluorescent strip unit</p>		I	1 6/1 2	0	101	101	101	96	96	96	87	87	87	79	79	79	72	72	72	68	68	68	
		1	85	81	77	81	77	73	73	70	67	66	64	62	60	58	56	58	56	53	56	54	53
		2	73	66	61	69	63	58	63	58	54	57	53	50	51	48	45	48	45	42	46	43	42
		3	63	56	50	60	53	48	55	49	44	50	45	41	45	41	38	45	41	38	43	39	35
		4	56	47	41	53	46	40	48	42	37	44	39	34	40	35	32	40	35	32	38	33	29
		5	49	40	34	46	39	33	42	36	31	38	33	29	35	30	26	35	30	26	34	29	24
		6	43	35	29	41	34	28	38	31	26	34	29	24	31	26	23	31	26	23	30	25	21
		7	39	31	25	37	29	24	34	27	23	31	25	21	28	23	19	28	23	19	27	22	17
		8	34	27	21	33	26	21	30	24	19	27	22	18	25	20	17	25	20	17	24	19	15
		9	31	23	18	30	23	18	27	21	17	25	19	15	23	18	14	23	18	14	22	17	13
10	28	21	16	27	20	16	25	19	15	22</													

TABLE 6.6 Lamp Group and Burnout Replacement Factors

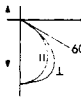
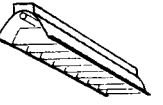
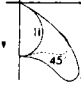
Lamp Type	Group Replacement	Burnout Replacement
Fluorescent	0.90	0.85
Incandescent	0.94	0.88
Metal-halide	0.87	0.80
Mercury	0.82	0.74
Tungsten-halogen	0.94	0.88
High-pressure sodium	0.94	0.88

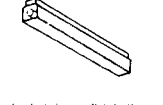
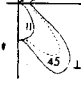
Lamp burnouts: If lamps are replaced as they burn out, use a factor of 0.95. If a group replacement maintenance program is employed, use a factor of 1.

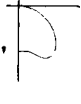
Lamp lumen depreciation: All lamps put out less light as they age. Specific information is available from each manufacturer, or you can use the figures in Table 6.14. For preliminary calculations the factors in Table 6.6 can also be used.

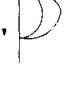
Luminaire Dirt Depreciation (LDD)

This factor depends on the type of luminaire, its design, the maintenance schedule of cleaning, and the cleanliness of the room in which the luminaire is used. The manufacturer's literature should give the maintenance category to which an individual fixture belongs. If not, follow the procedure given in Table 6.7 to find the maintenance category to which a fixture belongs.

Next, determine the degree of dirt conditions from the following examples:

Very clean: High-grade offices, not near production; laboratories; clean rooms

Clean: Offices in older buildings or near production, light assembly, inspection

Medium: Mill offices, paper processing, light machine

Dirty: Heat treating, high-speed printing, rubber processing

Very dirty: Similar to dirty but luminaires within immediate area of contamination

Finally, estimate the expected cleaning cycle. With these three factors, use Table 6.8 to determine the LDD factor.

TABLE 6.7 Procedure for Determining Luminaire Maintenance Categories

<p>To assist in determining Luminaire Dirt Depreciation (LDD) factors, luminaires are separated into six maintenance categories (I through VI). To arrive at categories, luminaires are arbitrarily divided into sections, a Top Enclosure and a Bottom Enclosure, by drawing a horizontal line through the light center of the lamp or lamps. The characteristics listed for the enclosures are then selected as best describing the luminaire. Only one characteristic for the top enclosure and one for the bottom enclosure should be used in determining the category of a luminaire. Percentage of uplight is based on 100% for the luminaire.</p> <p>The maintenance category is determined when there are characteristics in both enclosure columns. If a luminaire falls into more than one category, the lower numbered category is used.</p>		
Maintenance Category	Top Enclosure	Bottom Enclosure
I	1. None	1. None
II	<ol style="list-style-type: none"> 1. None 2. Transparent with 15% or more uplight through apertures. 3. Translucent with 15% or more uplight through apertures. 4. Opaque with 15% or more uplight through apertures. 	<ol style="list-style-type: none"> 1. None 2. Louvers or baffles
III	<ol style="list-style-type: none"> 1. Transparent with less than 15% upward light through apertures. 2. Translucent with less than 15% upward light through apertures. 3. Opaque with less than 15% upward light through apertures. 	<ol style="list-style-type: none"> 1. None 2. Louvers or baffles
IV	<ol style="list-style-type: none"> 1. Transparent unapertured. 2. Translucent unapertured. 3. Opaque unapertured. 	<ol style="list-style-type: none"> 1. None 2. Louvers
V	<ol style="list-style-type: none"> 1. Transparent unapertured. 2. Translucent unapertured. 3. Opaque unapertured. 	<ol style="list-style-type: none"> 1. Transparent unapertured 2. Translucent unapertured
VI	<ol style="list-style-type: none"> 1. None 2. Transparent unapertured. 3. Translucent unapertured. 4. Opaque unapertured. 	<ol style="list-style-type: none"> 1. Transparent unapertured 2. Translucent unapertured 3. Opaque unapertured

Source: IES Lighting Handbook 1981 Reference Volume.

Room Surface Dirt

This factor depends on the type of luminaire (how much it depends on surface reflectances), the type of use conditions, and the maintenance schedule. There are detailed ways of calculating this factor, but for preliminary design purposes, use the factors given in Table 6.9.

TABLE 6.8 Luminaire Dirt Depreciation Factors

Dirt Conditions	Cleaning Cycle in Years	Luminaire Maintenance Categories					
		I	II	III	IV	V	VI
Very clean	1.0	0.96	0.97	0.92	0.93	0.92	0.93
	1.5	0.95	0.96	0.90	0.91	0.91	0.90
	2.0	0.94	0.95	0.88	0.89	0.89	0.87
	3.0	0.92	0.94	0.84	0.86	0.87	0.82
Clean	1.0	0.93	0.93	0.90	0.88	0.88	0.87
	1.5	0.91	0.92	0.87	0.84	0.85	0.81
	2.0	0.89	0.90	0.84	0.81	0.83	0.77
	3.0	0.86	0.87	0.80	0.75	0.80	0.68
Medium	1.0	0.89	0.90	0.87	0.81	0.83	0.80
	1.5	0.86	0.88	0.83	0.75	0.79	0.73
	2.0	0.84	0.85	0.79	0.70	0.76	0.67
	3.0	0.79	0.82	0.73	0.62	0.71	0.56
Dirty	1.0	0.85	0.86	0.83	0.73	0.78	0.75
	1.5	0.81	0.83	0.78	0.66	0.73	0.67
	2.0	0.77	0.80	0.74	0.60	0.70	0.59
	3.0	0.71	0.75	0.67	0.50	0.64	0.47
Very dirty	1.0	0.74	0.83	0.79	0.64	0.73	0.67
	1.5	0.67	0.79	0.73	0.55	0.67	0.57
	2.0	0.62	0.75	0.68	0.47	0.63	0.48
	3.0	0.53	0.69	0.60	0.37	0.56	0.35

Source: IES Lighting Handbook 1981 Reference Volume.

In lieu of combining all of the factors just given, the *LLF* can be estimated by using the following combination of task and area types:

Clean	0.70
Light dirt	0.65
Medium dirt	0.60
Dirty	0.55
Very dirty	0.50

TABLE 6.9 Approximate Room Surface Dirt Depreciation Factors

Room Cleanliness	Luminaire Distribution Types				
	Direct	Semidirect	Direct-Indirect	Semi-indirect	Indirect
Very clean	0.97	0.95	0.94	0.94	0.89
Clean	0.95	0.91	0.87	0.85	0.80
Medium	0.94	0.88	0.83	0.81	0.73
Dirty	0.92	0.85	0.79	0.78	0.67
Very dirty	0.91	0.83	0.76	0.74	0.61

Source: IES Lighting Handbook 1981 Reference Volume.

Step-by-Step Calculations for the Number of Luminaires Required for a Particular Room

1. Compile the following information:
 - Length and width of room.
 - Height of floor cavity—the distance from the floor to the work surface (usually taken as 2.5 ft).
 - Height of the ceiling cavity—the distance from the ceiling to the light fixture. If the fixture is recessed or ceiling-(surface-) mounted, the value is zero.
 - Height of the room cavity—the distance from the work surface to the light fixture.
 - Surface reflectances—of the ceiling, the walls, and the floor. If the wall surface of the floor cavity is different from the room cavity wall surface (as with a wainscot, for example) obtain both figures. Surface reflectances are usually available from paint companies, ceiling tile manufacturers, and manufacturers of other finishes. If these are not readily available, use the values in Table 6.10.

TABLE 6.10 Reflectance Values of Various Materials and Colors

Material	Approximate Reflectance (in %)
Acoustical ceiling tile	75–85
Aluminum, brushed	55–58
Aluminum, polished	60–70
Clear glass	8–10
Granite	20–25
Marble	30–70
Stainless steel	55–65
Wood	
Light oak	25–35
Dark oak	10–15
Mahogany	6–12
Walnut	5–10
Color	
White	80–85
Light gray	45–70
Dark gray	20–25
Ivory white	70–80
Ivory	60–70
Pearl gray	70–75
Buff	40–70
Tan	30–50
Brown	20–40
Green	25–50
Azure blue	50–60
Sky blue	35–40
Pink	50–70
Cardinal red	20–25
Red	20–40

2. Determine cavity ratios:

$$CR = 2.5 \times \frac{\text{area of cavity wall}}{\text{area of base of cavity}}$$

For rectangular spaces the formula becomes

$$CR = 5h \times \frac{l + w}{l \times w}$$

where: h = height of the cavity
 l = length of the room
 w = width of the room

Note that if the work surface is the floor or if the luminaires are surface-mounted, the floor cavity ratio or ceiling cavity ratio, respectively, are zero. Also, because the three cavity ratios are related, after finding one you can find the other two by ratios:

$$CCR = RCR \left(\frac{h_{cc}}{h_{rc}} \right)$$

$$FCR = RCR \left(\frac{h_{fc}}{h_{rc}} \right)$$

where: CCR = ceiling cavity ratio
 FCR = floor cavity ratio
 RCR = room cavity ratio
 h_{cc} = height of ceiling cavity
 h_{fc} = height of floor cavity
 h_{rc} = height of room cavity

You can find the cavity ratios by calculation or use the values given in Table 6.11. First find the RCR and then use the ratios to find the values of the CCR and FCR .

3. Determine the effective ceiling cavity reflectance and the effective floor cavity reflectance. These are values of the imaginary planes at the height of the luminaire and the work surface that will be used in finding the coefficient of utilization of a particular light fixture. If the luminaires are recessed or surface-mounted, the effective ceiling cavity reflectance is the same as the reflectance of the ceiling itself. Use Table 6.12 to find the effective reflectances, knowing the cavity ratios you determined in step 2.
4. Determine the coefficient of utilization of the fixture under consideration by using the CU tables from the manufacturer's literature or from Table 6.5. Straight-line interpolation will probably be necessary. Most tables are set up for a floor reflectance of 20 percent. If the effective floor reflectance varies significantly from this,

use the correction factors given in Table 6.13 and multiply by the *CU* for the fixture.

5. Determine the recommended illumination for the space being designed. Follow the procedure outlined in Section 6.1 (“How to Select the Recommended Illuminance Level”).
6. Determine the lumen output of the lamps that will be used in the luminaire you have selected. Values for lumen output for some representative lamps are given in Table 6.14. More accurate data can be obtained from the fixture manufacturer or a lamp manufacturer. Determine the number of lamps that will be used in each luminaire.
7. With the information compiled in the previous steps and with the light loss factor (*LLF*), use the following formula.

$$\text{Number of luminaires} = \frac{\text{footcandles required} \times \text{area of room}}{N \times \text{lumens per lamp} \times CU \times LLF}$$

You can also determine the area per luminaire using the formula given at the beginning of this section.

6.3 LAMP CHARACTERISTICS AND SELECTION GUIDE (TABLES 6.14 THROUGH 6.18)

6.4 HOW LIGHT AFFECTS COLOR (TABLE 6.19)

Relationship of Light and Color

Light is the radiant energy produced by a light source. It may come to your eye directly from the source, or be reflected or transmitted by some object.

Color is the interaction of the light source, the reflector or transmitter, and our own ability to detect the color of light. Remember, you cannot perceive color without light. Different light sources radiate different wavelengths of light, influencing the appearance of colored objects or surfaces.

Color Temperature

Color temperature describes how the lamp itself appears when lit. Color temperature is measured by *Kelvin degrees*, ranging from 9000K (which appears blue) down to 1500K (which appears orange-red). Light sources lie somewhere between the two, with those of higher color temperature (4000K or more) being “cool,” and those of lower color temperature (3100K or less) being “warm.” Certain fluorescent lamps are “intermediate” types, lying somewhere between cool and warm.

TABLE 6.11 Room Cavity Ratios

Room	Room W L	Cavity Depth														
		2.5	5.5	6.0	6.5	7.0	7.5	8.0	8.5	9.0	10.0	12.0	14.0	16.0	18.0	
10	10	2.5	5.5	6.0	6.5	7.0	7.5	8.0	8.5	9.0						
	12	2.3	5.0	5.5	6.0	6.4	6.9	7.3	7.8	8.3						
	14	2.1	4.7	5.1	5.6	6.0	6.4	6.9	7.3	7.7	8.6					
	15	2.1	4.6	5.0	5.4	5.8	6.3	6.7	7.1	7.5	8.3					
	16	2.0	4.5	4.9	5.3	5.7	6.1	6.5	6.9	7.3	8.1					
12	12	2.1	4.6	5.0	5.4	5.8	6.3	6.7	7.1	7.5	8.3					
	14	1.9	4.3	4.6	5.0	5.4	5.8	6.2	6.6	7.0	7.7					
	16	1.8	4.0	4.4	4.7	5.1	5.5	5.8	6.2	6.6	7.3					
	18	1.7	3.8	4.2	4.5	4.9	5.2	5.6	5.9	6.3	6.9					
	20	1.7	3.7	4.0	4.3	4.7	5.0	5.3	5.7	6.0	6.7					
14	14	1.8	3.9	4.3	4.6	5.0	5.4	5.7	6.1	6.4	7.1	8.6				
	16	1.7	3.7	4.0	4.4	4.7	5.0	5.4	5.7	6.0	6.7	8.0				
	18	1.6	3.5	3.8	4.1	4.4	4.8	5.1	5.4	5.7	6.3	7.6				
	20	1.5	3.3	3.6	3.9	4.3	4.6	4.9	5.2	5.5	6.1	7.3				
	22	1.5	3.2	3.5	3.8	4.1	4.4	4.7	5.0	5.3	5.8	7.0				
16	16	1.6	3.4	3.8	4.1	4.4	4.7	5.0	5.3	5.6	6.3	7.5	8.8			
	18	1.5	3.2	3.5	3.8	4.1	4.4	4.7	5.0	5.3	5.9	7.1	8.3			
	20	1.4	3.1	3.4	3.7	3.9	4.2	4.5	4.8	5.1	5.6	6.8	7.9			
	22	1.3	3.0	3.2	3.5	3.8	4.0	4.3	4.6	4.9	5.4	6.5	7.6			
	24	1.3	2.9	3.1	3.4	3.6	3.9	4.2	4.4	4.7	5.2	6.3	7.3			
18	18	1.4	3.1	3.3	3.6	3.9	4.2	4.4	4.7	5.0	5.6	6.7	7.8	8.9		
	22	1.3	2.8	3.0	3.3	3.5	3.8	4.0	4.3	4.5	5.1	6.1	7.1	8.1		
	26	1.2	2.6	2.8	3.1	3.3	3.5	3.8	4.0	4.2	4.7	5.6	6.6	7.5		
	30	1.1	2.4	2.7	2.9	3.1	3.3	3.6	3.8	4.0	4.4	5.3	6.2	7.1		
	34	1.1	2.3	2.5	2.8	3.0	3.2	3.4	3.6	3.8	4.2	5.1	5.9	6.8		

20	20	1.3	2.8	3.0	3.3	3.5	3.8	4.0	4.3	4.5	5.0	6.0	7.0	8.0	9.0
	24	1.1	2.5	2.8	3.0	3.2	3.4	3.7	3.9	4.1	4.6	5.5	6.4	7.3	8.3
	28	1.1	2.4	2.6	2.8	3.0	3.2	3.4	3.6	3.9	4.3	5.1	6.0	6.9	7.7
	32	1.0	2.2	2.4	2.6	2.8	3.0	3.3	3.5	3.7	4.1	4.9	5.7	6.5	7.3
	36	1.0	2.1	2.3	2.5	2.7	2.9	3.1	3.3	3.5	3.9	4.7	5.4	6.2	7.0
24	24	1.0	2.3	2.5	2.7	2.9	3.1	3.3	3.5	3.8	4.2	5.0	5.8	6.7	7.5
	28	1.0	2.1	2.3	2.5	2.7	2.9	3.1	3.3	3.5	3.9	4.6	5.4	6.2	7.0
	32	0.9	2.0	2.2	2.4	2.6	2.7	2.9	3.1	3.3	3.6	4.4	5.1	5.8	6.6
	36	0.9	1.9	2.1	2.3	2.4	2.6	2.8	3.0	3.1	3.5	4.2	4.9	5.6	6.3
	40	0.8	1.8	2.0	2.2	2.3	2.5	2.7	2.8	3.0	3.3	4.0	4.7	5.3	6.0
28	34	0.8	0.8	2.1	2.3	2.4	2.4	2.6	2.8	2.9	3.3	3.9	4.6	5.2	5.9
	40	0.8	0.8	2.0	2.1	2.3	2.3	2.4	2.6	2.7	3.0	3.6	4.3	4.9	5.5
	46	0.7	0.7	1.9	2.0	2.2	2.2	2.3	2.4	2.6	2.9	3.4	4.0	4.6	5.2
	52	0.7	1.9	1.8	1.9	2.1	2.1	2.2	2.3	2.5	2.7	3.3	3.8	4.4	4.9
32	38	0.7	0.7	2.2	2.3	2.4	2.2	2.3	2.4	2.6	2.9	3.5	4.0	4.6	5.2
	44	0.7	0.7	2.0	2.2	2.3	2.4	2.2	2.3	2.4	2.7	3.2	3.8	4.3	4.9
	50	0.6	0.6	1.9	2.1	2.2	2.3	2.1	2.2	2.3	2.6	3.1	3.6	4.1	4.6
	56	0.6	0.6	1.8	2.0	2.1	2.2	2.0	2.1	2.2	2.5	2.9	3.4	3.9	4.4
38	46	0.6	0.6	1.8	1.9	2.0	2.2	1.9	2.0	2.2	2.4	2.9	3.4	3.8	4.3
	54	0.6	0.6	1.7	1.8	1.9	2.0	1.8	1.9	2.0	2.2	2.7	3.1	3.6	4.0
	62	0.5	0.5	1.6	1.7	1.8	1.9	1.8	1.8	1.9	2.1	2.5	3.0	3.4	3.8
	70	0.5	0.5	1.6	1.7	1.8	1.8	1.7	1.8	1.9	2.0	2.4	2.8	3.2	3.7
44	50	0.5	0.5	1.8	1.9	2.0	2.1	1.8	1.9	2.0	2.2	2.6	3.0	3.4	3.8
	60	0.5	0.5	1.7	1.8	1.9	2.0	1.7	1.8	1.9	2.0	2.4	2.8	3.2	3.5
	70	0.5	0.5	1.6	1.7	1.7	1.9	1.6	1.7	1.7	1.9	2.2	2.6	3.0	3.3
	80	0.4	0.4	1.5	1.6	1.6	1.8	1.5	1.6	1.6	1.8	2.1	2.5	2.8	3.2

TABLE 6.12 Percent Effective Ceiling or Floor Cavity Reflectances for Various Reflectance Combinations

Per Cent Base* Reflectance	90										80										70										60										50									
	90	80	70	60	50	40	30	20	10	0	90	80	70	60	50	40	30	20	10	0	90	80	70	60	50	40	30	20	10	0	90	80	70	60	50	40	30	20	10	0	90	80	70	60	50	40	30	20	10	0
Cavity Ratio																																																		
0.2	89	88	88	87	86	85	85	84	84	82	79	78	78	77	77	76	76	75	74	72	70	69	68	68	67	67	66	66	65	64	60	59	59	59	58	57	56	56	55	53	50	50	49	49	48	48	47	46	46	44
0.4	86	87	86	85	84	83	81	80	79	76	79	77	76	75	74	73	72	71	70	68	69	68	67	66	65	64	63	62	61	58	60	59	59	58	57	55	54	53	52	50	50	49	48	48	47	46	45	45	44	42
0.6	87	86	84	82	80	79	77	76	74	73	78	76	75	73	71	70	68	66	65	63	69	67	65	64	63	61	59	58	57	54	60	58	57	56	55	53	51	51	50	46	50	48	47	46	45	44	43	42	41	38
0.8	87	85	82	80	77	75	73	71	69	67	78	75	73	71	69	67	65	63	61	57	68	66	64	62	60	58	56	55	53	50	59	57	56	55	54	51	48	47	46	43	50	48	47	45	44	42	40	39	38	36
1.0	86	83	80	77	75	72	69	66	64	62	77	74	72	69	67	65	62	60	57	55	68	65	62	60	58	55	53	52	50	47	59	57	55	53	51	48	45	44	43	41	50	48	46	44	43	41	38	37	36	34
1.2	85	82	78	75	72	69	66	63	60	57	76	73	70	67	64	61	58	55	53	51	67	64	61	59	57	54	50	48	46	44	59	56	54	51	49	46	44	42	40	38	50	47	45	43	41	39	36	35	34	29
1.4	85	80	77	73	69	65	62	59	57	52	76	72	68	65	62	59	55	53	50	48	67	63	60	58	55	51	47	45	44	41	59	56	53	49	47	44	41	39	38	36	50	47	45	42	40	38	35	34	32	27
1.6	84	79	75	71	67	63	59	56	53	50	75	71	67	63	60	57	53	50	47	44	67	62	59	56	53	47	45	43	41	38	59	55	52	48	45	42	39	37	35	33	50	47	44	41	39	36	33	32	30	26
1.8	83	78	73	69	64	60	56	53	50	48	75	70	66	62	58	54	50	47	44	41	66	61	58	54	51	46	42	40	38	35	58	55	51	47	44	40	37	35	33	31	50	46	43	40	38	35	31	30	28	25
2.0	83	77	72	67	62	56	53	50	47	43	74	69	64	60	56	52	48	45	41	38	66	60	56	52	49	45	40	38	36	33	58	54	50	46	43	39	35	33	31	29	50	46	43	40	37	34	30	28	26	24
2.2	82	76	70	65	59	54	50	47	44	40	74	68	63	58	54	49	45	42	38	35	66	60	55	51	48	43	38	36	34	32	58	53	49	45	42	37	34	31	29	28	50	46	42	38	36	33	29	27	24	22
2.4	82	75	69	64	58	53	48	45	41	37	73	67	61	56	52	47	43	40	36	33	65	60	54	50	46	41	37	35	32	30	58	53	48	44	41	36	32	30	27	26	50	46	42	37	35	31	27	25	23	21
2.6	81	74	67	62	56	51	46	42	38	35	73	66	60	55	50	45	41	38	34	31	65	59	54	49	45	40	35	33	30	28	58	53	48	43	39	35	31	28	26	24	50	46	41	37	34	30	26	23	21	20
2.8	81	73	66	60	54	49	44	40	36	34	73	65	59	53	48	43	39	36	32	29	65	59	53	48	43	38	33	30	28	26	58	53	47	43	38	34	29	27	24	22	50	46	41	36	33	29	25	22	20	19
3.0	80	72	64	58	52	47	42	38	34	30	72	65	58	52	47	42	37	34	30	27	64	58	52	47	42	37	32	29	27	24	57	52	46	42	37	32	28	25	23	20	50	45	40	36	32	28	24	21	19	17
3.2	79	71	63	56	50	45	40	36	32	28	72	65	57	51	45	40	35	33	28	25	64	58	51	46	40	36	31	28	25	23	57	51	45	41	36	31	27	23	22	18	50	44	39	35	31	27	23	20	18	16
3.4	79	70	62	54	48	43	38	34	30	27	71	64	56	49	44	39	34	32	27	24	64	57	50	45	39	35	29	27	24	22	57	51	45	40	35	30	26	23	20	17	50	44	39	35	30	26	22	19	17	15
3.6	78	69	61	53	47	42	36	32	28	25	71	63	54	48	43	38	32	30	25	23	63	56	49	44	38	33	28	25	22	20	57	50	44	39	34	29	25	22	19	16	50	44	39	34	29	25	21	18	16	14
3.8	78	69	60	51	45	40	35	31	27	23	70	62	53	47	41	36	31	28	24	22	63	56	49	43	37	32	27	24	21	19	57	50	43	38	33	29	24	21	19	15	50	44	38	34	29	25	21	17	15	13
4.0	77	69	58	51	44	39	33	29	25	22	70	61	53	46	40	35	30	26	22	20	63	55	48	42	36	31	26	23	20	17	57	49	42	37	32	28	23	20	18	14	50	44	38	33	28	24	20	17	15	12
4.2	77	62	57	50	43	37	32	28	24	21	69	60	52	45	39	34	29	25	21	18	62	55	47	41	35	30	25	22	19	16	56	49	42	37	32	27	22	19	17	14	50	43	37	32	28	24	20	17	14	12
4.4	76	61	56	49	42	36	31	27	23	20	69	60	51	44	38	33	28	24	20	17	62	54	46	40	34	29	24	21	18	15	56	49	42	36	31	27	22	19	16	13	50	43	37	32	27	23	19	16	13	11
4.6	76	60	55	47	40	35	30	26	22	18	69	59	50	43	37	32	27	23	19	15	62	53	45	39	33	28	24	21	17	14	56	49	41	35	30	26	21	18	16	13	50	43	36	31	26	22	18	15	13	10
4.8	75	59	54	46	39	34	28	25	21	18	68	58	49	42	36	31	26	22	18	14	62	53	45	38	32	27	23	20	16	13	56	46	41	34	29	25	21	18	15	12	50	43	36	31	26	22	18	15	12	09
5.0	75	59	53	45	38	33	28	24	20	16	68	58	48	41	35	30	25	21	18	14	61	52	44	36	31	26	22	19	16	12	56	46	40	34	28	24	20	17	14	11	50	42	35	30	25	21	17	14	12	09
6.0	73	61	49	41	34	29	24	20	16	11	66	55	44	38	31	27	22	19	15	10	60	51	41	35	28	24	19	16	13	09	55	45	37	31	25	21	17	14	11	07	50	42	34	29	23	19	15	13	10	06
7.0	70	58	45	38	30	27	21	18	14	08	64	53	41	35	28	24	19	16	12	07	58	48	38	32	26	22	17	14	11	06	54	43	35	30	24	20	15	12	09	05	49	41	32	27	21	18	14	11	08	05
8.0	68	55	42	35	27	23	18	15	12	06	62	50	38	32	25	21	17	14	11	05	57	46	35	29	23	19	15	13	10	05	53	42	33	28	22	18	14	11	08	04	49	40	30	25	19	16	12	10	07	03
9.0	66	52	38	31	25	21	16	14	11	05	61	49	36	30	23	19	15	13	10	04	56	45	33	27	21	18	14	12	09	04	52	40	31	26	20	16	12	10	07	03	48	39	29	24	18	15	11	09	07	03
10.0	65	51	36	29	22	19	15	11	09	04	59	46	33	27	21	18	14	11	08	03	55	43	31	25	19	16	12	10	08	03	51	39	29	24	18	15	11	09	07	02	47	37	27	22	17	14	10	08	06	02

* Ceiling, floor or floor of cavity

426



TABLE 6.12 Percent Effective Ceiling or Floor Cavity Reflectances for Various Reflectance Combinations (*Continued*)

Per Cent Base Reflectance	40										30										20										10										0									
Per Cent Wall Reflectance	90	80	70	60	50	40	30	20	10	0	90	80	70	60	50	40	30	20	10	0	90	80	70	60	50	40	30	20	10	0	90	80	70	60	50	40	30	20	10	0	90	80	70	60	50	40	30	20	10	0
Cavity Ratio																																																		
0.2	40	40	39	39	38	38	37	36	36	31	31	30	30	29	29	28	28	27	21	20	20	20	20	19	19	19	17	11	11	11	10	10	10	10	09	09	09	02	02	02	01	01	01	01	00	00	00			
0.4	41	40	39	39	38	37	36	35	34	34	31	31	30	30	29	28	28	27	26	25	22	21	20	20	20	19	19	18	18	16	12	11	11	11	11	10	10	09	09	08	04	03	03	02	02	02	01	01	01	00
0.6	41	40	39	38	37	36	34	33	32	31	32	31	30	29	28	27	26	26	25	23	23	21	21	20	19	19	18	18	17	15	13	13	12	11	11	10	10	09	08	08	05	05	04	03	03	02	02	01	01	01
0.8	41	40	38	37	36	35	33	32	31	29	32	31	30	29	28	26	25	25	23	22	24	22	21	20	19	19	18	17	16	14	15	14	13	12	11	10	10	09	08	07	07	06	05	04	04	03	02	02	01	01
1.0	42	40	38	37	35	33	32	31	29	27	33	32	30	29	27	25	24	23	22	20	25	23	22	20	19	18	17	16	15	13	16	14	13	12	12	11	10	09	08	07	08	07	06	05	04	03	02	02	01	01
1.2	42	40	38	36	34	32	30	29	27	25	33	32	30	28	27	25	23	22	21	19	25	23	22	20	19	17	17	16	14	12	17	15	14	13	12	11	10	09	07	06	10	08	07	06	05	04	03	02	01	01
1.4	42	39	37	35	33	31	29	27	25	23	34	32	30	28	26	24	22	21	19	18	26	24	22	20	18	17	16	15	13	12	18	16	14	13	12	11	10	09	07	06	11	09	08	07	06	04	03	02	01	01
1.6	42	39	37	35	32	30	27	25	23	22	34	33	29	27	25	23	22	20	18	17	26	24	22	20	18	17	16	15	13	11	19	17	15	14	12	11	09	08	07	06	12	10	09	07	06	05	03	02	01	01
1.8	42	39	36	34	31	29	26	24	22	21	35	33	29	27	25	23	21	19	17	16	27	25	23	20	18	17	15	14	12	10	19	17	15	14	13	11	09	08	06	05	13	11	09	08	07	05	04	03	01	01
2.0	42	39	36	34	31	28	25	23	21	19	35	33	29	26	24	22	20	18	16	14	28	25	23	20	18	16	15	13	11	09	20	18	16	14	13	11	09	08	06	05	14	12	10	09	07	05	04	03	01	01
2.2	42	39	36	33	30	27	24	22	19	18	36	32	29	26	24	22	19	17	15	13	28	25	23	20	18	16	14	12	10	09	21	19	16	14	13	11	09	07	06	05	15	13	11	09	07	06	04	03	01	01
2.4	43	39	35	33	29	27	24	21	18	17	36	32	29	26	24	22	19	16	14	12	29	26	23	20	18	16	14	12	10	08	22	19	17	15	13	11	09	07	06	05	16	13	11	09	08	06	04	03	01	01
2.6	43	39	35	32	29	26	23	20	17	15	36	32	29	25	23	21	18	16	14	12	29	26	23	20	18	16	14	11	09	08	23	20	17	15	13	11	09	07	06	04	17	14	12	10	08	06	05	03	02	01
2.8	43	39	35	32	28	25	22	19	16	14	37	33	29	25	23	21	17	15	13	11	30	27	23	20	18	15	13	11	09	07	23	20	18	16	13	11	09	07	05	03	17	15	13	10	08	07	05	03	02	01
3.0	43	39	35	31	27	24	21	18	15	13	37	33	29	25	22	20	17	15	12	10	30	27	23	20	17	15	13	11	09	07	24	21	18	16	13	11	09	07	05	03	18	16	13	11	09	07	05	03	02	01
3.2	43	39	35	31	27	23	20	17	15	13	37	33	29	25	22	19	16	14	12	10	31	27	23	20	17	15	12	11	09	06	25	21	18	16	13	11	09	07	05	03	19	16	14	11	09	07	05	03	02	01
3.4	43	39	34	30	26	23	20	17	14	12	37	33	29	25	22	19	16	14	11	09	31	27	23	20	17	15	12	10	08	06	26	22	18	16	13	11	09	07	05	03	20	17	14	12	09	07	05	03	02	01
3.6	44	39	34	30	26	22	19	16	14	11	38	33	29	24	21	18	15	13	10	09	32	27	23	20	17	15	12	10	08	05	26	22	19	16	13	11	09	06	04	03	20	17	15	12	10	08	05	04	02	01
3.8	44	38	33	29	25	22	18	16	13	10	38	33	28	24	21	18	15	13	10	08	32	28	23	20	17	15	12	10	07	05	27	23	19	17	14	11	09	06	04	02	21	18	15	12	10	08	05	04	02	01
4.0	44	38	33	29	25	21	18	15	12	10	38	33	28	24	21	18	14	12	09	07	33	28	23	20	17	14	11	09	07	05	27	23	20	17	14	11	09	06	04	02	22	18	15	13	10	08	05	04	02	01
4.2	44	38	33	29	24	21	17	15	12	10	38	33	28	24	20	17	14	12	09	07	33	28	23	20	17	14	11	09	07	04	28	24	20	17	14	11	09	06	04	02	22	19	16	13	10	08	06	04	02	01
4.4	44	38	33	28	24	20	17	14	11	09	39	33	28	24	20	17	14	11	09	06	34	28	24	20	17	14	11	09	07	04	28	24	20	17	14	11	08	06	04	02	23	19	16	13	10	08	06	04	02	01
4.6	44	38	32	28	23	19	16	14	11	08	39	33	28	24	20	17	13	10	08	06	34	29	24	20	17	14	11	09	07	04	29	25	20	17	14	11	08	06	04	02	23	20	17	13	11	08	06	04	02	01
4.8	44	38	32	27	22	19	16	13	10	08	39	33	28	24	20	17	13	10	08	05	35	29	24	20	17	13	10	08	06	04	29	25	20	17	14	11	08	06	04	02	24	20	17	14	11	08	06	04	02	01
5.0	45	38	31	27	22	19	15	13	10	07	39	33	28	24	19	16	13	10	08	05	35	29	24	20	16	13	10	08	06	04	30	25	20	17	14	11	08	06	04	02	25	21	17	14	11	08	06	04	02	01
6.0	44	37	30	25	20	17	13	11	08	05	39	33	27	23	18	15	11	09	06	04	36	30	24	20	16	13	10	08	05	02	31	26	21	18	14	11	08	06	03	01	27	23	18	15	12	09	06	04	02	01
7.0	44	36	29	24	19	16	12	10	07	04	40	33	26	22	17	14	10	08	05	03	36	30	24	20	15	12	09	07	04	02	32	27	21	17	13	11	08	06	03	01	28	24	19	15	12	09	06	04	02	01
8.0	44	35	28	23	18	15	11	09	06	03	40	33	26	21	16	13	09	07	04	02	37	30	23	19	15	12	08	06	03	01	33	27	21	17	13	10	07	05	03	01	30	25	20	15	12	09	06	04	02	01
9.0	44	35	26	21	16	13	10	08	05	02	40	35	25	20	15	12	09	07	04	02	37	29	23	19	14	11	08	06	03	01	34	28	21	17	13	10	07	05	02	01	31	25	20	15	12	09	06	04	02	01
10.0	43	34	25	20	15	12	08	07	05	02	40	32	24	19	14	11	08	06	03	01	37	29	22	18	13	10	07	05	03	01	34	28	21	17	12	10	07	05	02	01	31	25	20	15	12	09	06	04	02	01

* Ceiling, floor or floor of cavity



TABLE 6.13 Multiplying Factors for Other than 20 Percent Effective Floor Cavity Reflectance

% Effective Ceiling Cavity Reflectance, ρ_{cc}	80				70				50			30			10		
	70	50	30	10	70	50	30	10	50	30	10	50	30	10	50	30	10
For 30 Per Cent Effective Floor Cavity Reflectance (20 Per Cent = 1.00)																	
Room Cavity Ratio																	
1	1.092	1.082	1.075	1.068	1.077	1.070	1.064	1.059	1.049	1.044	1.040	1.028	1.026	1.023	1.012	1.010	1.008
2	1.079	1.066	1.055	1.047	1.068	1.057	1.048	1.039	1.041	1.033	1.027	1.026	1.021	1.017	1.013	1.010	1.006
3	1.070	1.054	1.042	1.033	1.061	1.048	1.037	1.028	1.034	1.027	1.020	1.024	1.017	1.012	1.014	1.009	1.005
4	1.062	1.045	1.033	1.024	1.055	1.040	1.029	1.021	1.030	1.022	1.015	1.022	1.015	1.010	1.014	1.009	1.004
5	1.056	1.038	1.026	1.018	1.050	1.034	1.024	1.015	1.027	1.018	1.012	1.020	1.013	1.008	1.014	1.009	1.004
6	1.052	1.033	1.021	1.014	1.047	1.030	1.020	1.012	1.024	1.015	1.009	1.019	1.012	1.006	1.014	1.008	1.003
7	1.047	1.029	1.018	1.011	1.043	1.026	1.017	1.009	1.022	1.013	1.007	1.018	1.010	1.005	1.014	1.008	1.003
8	1.044	1.026	1.015	1.009	1.040	1.024	1.015	1.007	1.020	1.012	1.006	1.017	1.009	1.004	1.013	1.007	1.003
9	1.040	1.024	1.014	1.007	1.037	1.022	1.014	1.006	1.019	1.011	1.005	1.016	1.009	1.004	1.013	1.007	1.002
10	1.037	1.022	1.012	1.006	1.034	1.020	1.012	1.005	1.017	1.010	1.004	1.015	1.009	1.003	1.013	1.007	1.002

For 10 Per Cent Effective Floor Cavity Reflectance (20 Per Cent = 1.00)

Room Cavity Ratio	923	929	935	940	933	939	943	948	956	960	963	973	976	979	989	991	993
1	.931	.942	.950	.958	.940	.949	.957	.963	.962	.968	.974	.976	.980	.985	.988	.991	.995
2	.939	.951	.961	.969	.945	.957	.966	.973	.967	.975	.981	.978	.983	.988	.988	.992	.996
3	.944	.958	.969	.978	.950	.963	.973	.980	.972	.980	.986	.980	.986	.991	.987	.992	.996
4	.949	.964	.976	.983	.954	.968	.978	.985	.975	.983	.989	.981	.988	.993	.987	.992	.997
5	.953	.969	.980	.986	.958	.972	.982	.989	.977	.985	.992	.982	.989	.995	.987	.993	.997
6	.957	.973	.983	.991	.961	.975	.985	.991	.979	.987	.994	.983	.990	.996	.987	.993	.998
7	.960	.976	.986	.993	.963	.977	.987	.993	.981	.988	.995	.984	.991	.997	.987	.994	.998
8	.963	.978	.987	.994	.965	.979	.989	.994	.983	.990	.996	.985	.992	.998	.988	.994	.999
9	.965	.980	.989	.995	.967	.981	.990	.995	.984	.991	.997	.986	.993	.998	.988	.994	.999
10																	

For 0 Per Cent Effective Floor Cavity Reflectance (20 Per Cent = 1.00)

Room Cavity Ratio	859	.870	.879	.886	.873	.884	.893	.901	.916	.923	.929	.948	.954	.960	.979	.983	.987
1	.871	.887	.903	.919	.886	.902	.916	.928	.926	.938	.949	.954	.963	.971	.978	.983	.991
2	.882	.904	.915	.942	.898	.918	.934	.947	.936	.950	.964	.958	.969	.979	.976	.984	.993
3	.893	.919	.941	.958	.908	.930	.948	.961	.945	.961	.974	.961	.974	.984	.975	.985	.994
4	.903	.931	.953	.969	.914	.939	.958	.970	.951	.967	.980	.964	.977	.988	.975	.985	.995
5	.911	.940	.961	.976	.920	.945	.965	.977	.955	.972	.985	.966	.979	.991	.975	.986	.996
6	.917	.947	.967	.981	.924	.950	.970	.982	.959	.975	.988	.968	.981	.993	.975	.987	.997
7	.922	.953	.971	.985	.929	.955	.975	.986	.963	.978	.991	.970	.983	.995	.976	.988	.998
8	.928	.958	.975	.988	.933	.959	.980	.989	.966	.980	.993	.971	.985	.996	.976	.988	.998
9	.933	.962	.979	.991	.937	.963	.983	.992	.969	.982	.995	.973	.987	.997	.977	.989	.999
10																	

TABLE 6.14 Characteristics of Typical Lamps

Standard Incandescent						
Bulb Description	Watts	Length/Size (in in.)	Lamp Life (in hours) (1)	Color Temp. °K (1)	Initial Lumens (1)	Lamp Lumen Depreciation (1)
A-19	60		1000	2790	860	0.93
A-19	75		750	2840	1180	0.92
A-19	100		750	2900	1740	0.91
A-19	100		2500		1490	0.93
A-21	100		750	2880	1690	0.90
A-21	150		750	2960	2880	0.89
A-23	150		2500		2350	0.89
PS-25	150		750	2900	2660	0.88
A-23	200		750	2980	4000	0.90
A-23	200		2500		3400	0.88
PS-25	300		750	3010	6360	0.88
PS-30	300		2500		5200	0.79
PS-35	500		1000	3050	10600	0.89

R, PAR, and ER Lamps						
Bulb Description	Watts	Length/Size (in in.)	Lamp Life (in hours) (1)	Color Temp. (1)	Initial Lumens (1,2)	Lamp Lumen Depreciation (1)
R-30 Spot/Flood	75		2000		850	
R-40 Spot/Flood	150		2000		1825	
R-40 Spot/Flood	300		2000		3600	
PAR-38 Spot/Flood	100		2000		1250	
PAR-38 Spot/Flood	150		2000		1730	
ER-30	50		2000		525	
ER-30	75		2000		850	
ER-30	90		5000		950	
ER-40	120		2000		1475	

Fluorescent						
Bulb Description	Watts	Length/Size (in in.)	Lamp Life (in hours) (1,3)	Color Temp. (1,4)	Initial Lumens (1,5)	Lamp Lumen Depreciation (1)
F40T12CW/RS	40	48	20000	4300	3150	0.84
F40T12WW/RS	40	48	20000	3100	3170	0.84
F40T12CWX/RS	40	48	20000	4100	2200	0.84
F40T12WWX/RS	40	48	20000	3000	2170	0.84
F40T12D/RS	40	48	20000	6500	2600	0.84
F40T12W/RS	40	48	20000	3600	3180	0.84
F96T12CW	75	96	12000	4300	6300	0.89
F96T12WW	75	96	12000	3100	6335	0.89
F96T12CWX	75	96	12000	4100	4465	0.89
F96T12WWX	75	96	12000	3000	4365	

TABLE 6.14 Characteristics of Typical Lamps (*Continued*)

Tungsten-Halogen (Quartz-Iodine)						
Bulb Description	Watts	Length/ Size (in in.)	Lamp Life (in hours) (1)	Color Temp. (1)	Initial Lumens (1)	Lamp Lumen Depreciation (1)
T-4	100		1000		1800	0.93
T-4	150		1500	3000	2900	0.93
T-4	250		2000	2950	5000	0.97
PAR-38	250		6000		3500	0.95
Mercury						
Bulb Description	Watts	Length/ Size (in in.)	Lamp Life (in hours) (1)	Color Temp. (1)	Initial Lumens (1)	Lamp Lumen Depreciation (1)
H45AY-40/50 DX	50		16000		1680	
H43AY-75/DX	75		24000		3000	
H38BP-100/DX	100		24000 +		2865	
H38JA-100/WDX	100		24000 +		4000	
H38MP-100/DX	100		24000		4275	
H39BN-175/DX	175		24000		5800	
H39KC-175/DX	175		24000 +		8600	
H37KC-250/DX	250		24000 +		12775	
Metal-Halide						
Bulb Description	Watts	Length/ Size (in in.)	Lamp Life (in hours) (1)	Color Temp. (1)	Initial Lumens (1)	Lamp Lumen Depreciation (1)
M57PF-175	175		7500	3600	14000	
M58PH-250	250		10000		20500	
M59PK-400	400		1500	3800	34000	
High-Pressure Sodium						
Bulb Description	Watts	Length/ Size (in in.)	Lamp Life (in hours) (1)	Color Temp. (1)	Initial Lumens (1)	Lamp Lumen Depreciation (1)
S68MT-50	50		24000		3800	
S54MC-100	100		24000		8800	
S55MD-150	150		24000		15000	

(1) Figures listed are approximate. Exact values vary with manufacturer.

(2) Initial lumens for R, PAR, and ER lamps is for total lumens.

(3) Lamp life for fluorescent depends on number of hours per start; figures given are for approximately 10 hours per start.

(4) Technically, "color temperature" applies only to incandescent sources, but it is often used to describe the degree of whiteness of other light sources.

(5) Lumens at 40% of rated life.

TABLE 6.15 Guide to Lamp Selection

Lamp Type and Efficacy (1)	Lamp Appearance Effect on Neutral Surfaces	Effect on "Atmosphere"	Colors Strengthened	Colors Grayed	Effect on Complexions	Remarks
Fluorescent Cool white (#4) (2)	White	Neutral to moderately cool	Orange, blue, yellow	Red	Pale pink	Blends with natural daylight—good color acceptance
Deluxe cool white (#2) (2)	White	Neutral to moderately cool	All nearly equal	None appreciably	Most natural	Best overall color rendition, simulates natural daylight
Warm white (#4) (3)	Yellowish white	Warm	Orange, yellow	Red, green, blue	Sallow	Blends with incandescent light—poor color acceptance
Deluxe warm white (#2) (3)	Yellowish white	Warm	Red, orange, yellow, green	Blue	Ruddy	Good color rendition; simulates incandescent light
Daylight (#3)	Bluish white	Very cool	Green, blue	Red, orange	Grayed	Usually replaceable with cool white
White (#4)	Pale yellowish white	Moderately warm	Orange, yellow	Red, green, blue	Pale	Usually replaceable with cool white or warm white

(1) Efficacy (lumens/watt): #1 = low; #2 = medium; #3 = medium high; #4 = high.

(2) Greater preference at higher levels.

(3) Greater preference at lower levels.

Source: GE Lighting Business Group.

TABLE 6.15 Guide to Lamp Selection (Continued)

Lamp Type and Efficacy (1)	Lamp Appearance and Effect on Neutral Surfaces	Effect on "Atmosphere"	Colors Strengthened	Colors Grayed	Effect on Complexions	Remarks
<i>Incandescent, Tungsten-Halogen</i>						
Filament (#1) (3)	Yellowish white	Warm	Red, orange, yellow	Blue	Ruddiest	Good color rendering
<i>High-Intensity Discharge</i>						
Clear mercury (#2)	Greenish blue-white	Very cool, greenish	Yellow, green, blue	Red, orange	Greenish	Very poor color rendering
White mercury (#2)	Greenish white	Moderately cool, greenish	Yellow, green, blue	Red, orange	Very pale	Moderate color rendering
Deluxe white mercury (#2)	Purplish white	Warm, purplish	Red, yellow, blue	Green	Ruddy	Color acceptance similar to cool white fluorescent
Metal-Halide (#4) (2)	Greenish white	Moderately cool greenish	Yellow, blue, green	Red	Grayed	Color acceptance similar to cool white
High-pressure sodium (#4)	Yellowish	Warm, yellowish	Yellow, green, orange	Red, blue	Yellowish	Color acceptance approaches warm white fluorescent

(1) Efficacy (lumens/watt): #1 = low; #2 = medium; #3 = medium high; #4 = high.

(2) Greater preference at higher levels.

(3) Greater preference at lower levels.

Source: GE Lighting Business Group.

TABLE 6.16 Recommended Reflectances of Interior Surfaces

	Recommended Reflectances in Percent					
	Ceilings	Walls	Floors	Furniture	Other	
Offices	80+	50-70	20-40	25-45	40-70	Partitions Chalkboards Benchtops, machines, etc. Large drapery areas
Schools	70-90	40-60	30-50	35-50	up to 20	
Industrial	80-90	40-60	20+		25-45	
Residential	60-90	35-60 (1)	15-35 (1)		45-85	

(1) Where specific visual tasks are more important than lighting for environment, minimum reflectances should be 40% for walls and 25% for floors.

Source: Data extracted from IES Lighting Handbook, 1981 Applications Volume.

Color Rendition

Color rendition describes the effect a light source has on the appearance of colored objects. The color-rendering capability of a lamp is measured as the color-rendering index (CRI). In general, the higher the CRI, the less distortion of the object's color by the lamp's light output. The scale used ranges from 0 to 100. A CRI of 100 indicates that there is no color shift as compared with a reference source, and the lower the CRI, the more pronounced the shift may be.

It is important to recognize that the reference source (and thus the

TABLE 6.17 Recommended Luminance Ratios

Use	Task	Recommended Ratios (1)				
		Between task and immediate darker surroundings		Between task and immediate lighter surroundings	Between task and general surroundings	
		Minimum	Desired	Maximum	Minimum	Desired
Residential	1	1/5	1/3	5 (2)	0.1-10	0.2-5
Office	1		1/3			0.1-10
Classroom	1	1/3		3	1/3	
Merchandising	1	1/3	1/5			
Industrial	1		1/3		0.5-20	0.1-10

(1) These are recommended guidelines for most applications. Ratios higher or lower are acceptable if they do not exceed a significant portion of the visual field.

(2) Any significant surface normally viewed directly should be no greater than five times the luminance of the task.

Source: IES Lighting Handbook, 1981 Applications Volume.

TABLE 6.18 Compact Fluorescent Fixture Operation Data

	120 VOLT NPF	120 VOLT HPF	277 VOLT HPF	FIXTURE LUMEN LAMP	EQUIVALENT INCANDESCENT WATTAGE	STANDARD COLOR TEMP.	MIN. LAMP START TEMP
	FIXT. TOTAL AMPS/ WATTS	FIXT. TOTAL AMPS/ WATTS	FIXT. TOTAL AMPS/ WATTS	LUMENS Per WATT		C.R.I.**	
2 x 9W	.36/25	.20/25	.13/32	$\frac{1200}{67}$	75W	$\frac{2700^{\circ} \text{K}}{82}$	25° F
2 x 13W	.60/34	.28/34	.17/42	$\frac{1800}{69}$	120W	$\frac{2700^{\circ} \text{K}}{86}$	32° F
2 x 18W	.70/47	.44/47	.18/49	$\frac{2500}{69}$	150W	$\frac{2700^{\circ} \text{K}}{86}$	23° F
2 x 26W	1.0/64	.63/64	.26/54	$\frac{3600}{69}$	200W	$\frac{2700^{\circ} \text{K}}{86}$	23° F
1 x 9W	.18/13	.10/13	.065/13	$\frac{600}{67}$	40W	$\frac{2700^{\circ} \text{K}}{82}$	25° F
1 x 13W	.30/17	.14/17	.085/17	$\frac{900}{69}$	60W	$\frac{2700^{\circ} \text{K}}{82}$	32° F
1 x 18W	.35/24	.22/24	.09/24	$\frac{1250}{69}$	75W	$\frac{2700^{\circ} \text{K}}{86}$	23° F
1 x 26W	.50/32	.32/32	.13/32	$\frac{1800}{69}$	100W	$\frac{2700^{\circ} \text{K}}{86}$	23° F

* Consult Lamp Manufacturers
For Other Color Temp. Ratings

** Color Rendering Index

CRI scale) is different at different color temperatures. As a result, CRI values should only be compared between lamps of similar color temperatures.

Additional Factors Affect Color Appearance

The color-rendering properties of a lamp are an important influence on the color appearance of an object. However, many other factors will affect color appearance, such as the finishes used on walls, floors, and furnishings; the intensity level of the lighting; and the presence of daylight in the room. All these factors should be considered in selecting the appropriate light source. Additionally, the room decor is a critical consideration in selecting a light source. If colors such as reds and oranges are the main element, a warm light source (color temperature below 3200 K) would be the best choice. Conversely, if blues and violets are being used, cool lamps (color temperature above 4000 K) should be used. For areas with mixed cool and warm elements, or where neutral colors such as gray predominate, an intermediate color temperature source (3400 to 3600 K) should be considered.

TABLE 6.19 Summary of Light Source Characteristics and Effect on Color

Light Source	Characteristics	Effect on Color
<p>Incandescent Color temperatures from 2750K to 3400K. CRI: 95 +</p>	<ul style="list-style-type: none"> • Warm, inviting light • Standard light source • Relatively inefficient 	<ul style="list-style-type: none"> • Brightens reds, oranges, yellows • Darkens blues and greens
<p>Tungsten Halogen Color temperatures from 2850K to 3000K. CRI: 95 +</p>	<ul style="list-style-type: none"> • Brighter, whiter light than standard incandescent • More efficient than regular incandescent 	<ul style="list-style-type: none"> • Brightens reds, oranges, yellows • Darkens blues and greens
<p>Fluorescent Color temperatures from 2700K to 6300K. CRIs from 48 to 90</p>	<ul style="list-style-type: none"> • Wide selection of phosphor colors—select warm to cool lighting atmosphere • Generally high efficiency • Much longer life 	<ul style="list-style-type: none"> • Wide range of color temperatures and CRIs to light effectively any (basically indoor) area with a “warm” to “cool” environment as decor or task dictates
<p>High Intensity Discharge Metal Halide (Metalarc®) High Pressure Sodium (Lumalux® and Unalux®) Mercury</p>	<ul style="list-style-type: none"> • Different gases and phosphor colors create a variety of atmospheres • High efficiency • Very long life 	<ul style="list-style-type: none"> • Sylvania Metalarc® (metal halide) lamps provide excellent color rendering. Mercury and High Pressure Sodium provide poor color rendering. Mercury gives a blue-green coloration and High Pressure Sodium imparts an orange-yellow color

CHAPTER SEVEN

Special Systems

7.0 FIRE ALARM SYSTEMS

Introduction

Fire alarm systems have become increasingly sophisticated and functionally more capable and reliable in recent years. They are designed to fulfill two general requirements: (1) protection of property and assets and (2) protection of life. As a result of state and local codes, the life safety aspect of fire protection has become a major factor in the last two decades.

There are a number of reasons for the substantial increases in the life safety form of fire protection during recent years, foremost of which are:

1. The proliferation of high-rise construction and the concern for life safety within these buildings.
2. A growing awareness of the life safety hazard in residential, institutional, and educational occupancies.
3. Increased hazards caused by new building materials and furnishings that create large amounts of toxic combustion products, (i.e., plastics, synthetic fabrics, and so on).
4. Vast improvements in smoke detection and related technology made possible through quantum advances in electronic technology.
5. The passing of the Americans with Disabilities Act (ADA), signed into law on July 26, 1990, providing comprehensive civil rights protection for individuals with disabilities. With an effective date of January 26, 1992, these requirements include detailed accessibility standards for both new construction and renovation toward the goal of equal usability of buildings for everyone, regardless of limitations of sight, hearing, or mobility. This has had a significant impact on fire alarm system signaling devices, power requirements, and device locations.

Common Code Requirements

The following codes apply to fire alarm systems:

NFPA 70—National Electrical Code

NFPA 72—National Fire Alarm Code

NFPA 90A—Standard for the Installation of Air Conditioning and Ventilation Systems

NFPA 101—Life Safety Code

BOCA, SBCCI, ICBO—The National Basic Building Code and National Fire Prevention Code published by the Building Officials Code Administrators International (BOCA), the Uniform Building and Fire Code of the International Conference of Building Officials (ICBO), and the Standard Building Code and Standard Fire Prevention Code of the Southern Building Code Congress International (SBCCI) all have reference to fire alarm requirements.

Many states and municipalities have adopted these model building codes in full or in part.

You should consult with the local authority having jurisdiction (AHJ) to verify the requirements in your area.

Fire Alarm System Classifications

NFPA 72 classifies fire alarm systems as follows.

HOUSEHOLD FIRE ALARM SYSTEM

A system of devices that produces an alarm signal in the household for the purpose of notifying the occupants of the presence of fire so that they will evacuate the premises.

PROTECTED PREMISES (LOCAL) FIRE ALARM SYSTEM

A system that sounds an alarm at the protected premises as the result of the manual operation of a fire alarm box or the operation of protection equipment or systems, such as water flowing in a sprinkler system, the discharge of carbon dioxide, the detection of smoke, or the detection of heat.

AUXILIARY FIRE ALARM SYSTEM

A system connected to a municipal fire alarm system for transmitting an alarm of fire to the public fire service communications center. Fire alarms from an auxiliary fire alarm system are received at the public fire service communications center on the same equipment and by the same

methods as alarms transmitted manually from municipal fire alarm boxes located on streets. There are three subtypes of this system; local energy, parallel telephone, and shunt.

REMOTE SUPERVISING STATION FIRE ALARM SYSTEM

A system installed in accordance with NFPA 72 to transmit alarm, supervisory, and trouble signals from one or more protected premises to a remote location at which appropriate action is taken.

PROPRIETARY SUPERVISING STATION FIRE ALARM SYSTEM

An installation of fire alarm systems that serves contiguous and non-contiguous properties, under one ownership, from a proprietary supervising station located at the protected property, at which trained, competent personnel are in constant attendance. This includes the proprietary supervising station; power supplies; signal-initiating devices; initiating device circuits; signal notification appliances; equipment for the automatic, permanent visual recording of signals; and equipment for initiating the operation of emergency building control services.

CENTRAL STATION FIRE ALARM SYSTEM

A system or group of systems in which the operations of circuits and devices are transmitted automatically to, recorded in, maintained by, and supervised from a listed central station having competent and experienced servers and operators who, upon receipt of a signal, take action as required by NFPA 72. Such service is to be controlled and operated by a person, firm, or corporation whose business is the furnishing, maintaining, or monitoring of supervised fire alarm systems.

MUNICIPAL FIRE ALARM SYSTEM

A system of alarm-initiating devices, receiving equipment, and connecting circuits (other than a public telephone network) used to transmit alarms from street locations to the public fire service communications center.

Fire Alarm Fundamentals—Basic Elements

Regardless of type, application, complexity, or technology level, any fire alarm system is composed of four basic elements:

1. Initiating devices
2. Control panel
3. Signaling devices
4. Power supply

These components must be electrically compatible and are interconnected by means of suitable wiring circuits to form a complete functional system, as illustrated in Fig. 7.1.

Figure 7.1 shows a conventional version of a protected premises (local) fire alarm system, which is the most widely used classification type in commercial and institutional buildings. The requirements for this type of system are detailed in Chap. 3 of NFPA 72. Some highlights of that chapter's requirements are worthy of note and are given in abridged form in the following sections.

Circuit Designations

Initiating device, notification appliance, and signaling line circuits shall be designated by class or style, or both, depending on the circuits' capability to operate during specified fault conditions.

Class

Initiating device, notification appliance, and signaling line circuits shall be permitted to be designated as either Class A or Class B, depending on the capability of the circuit to transmit alarm and trouble signals dur-

FIGURE 7.1 Typical local protective signaling system

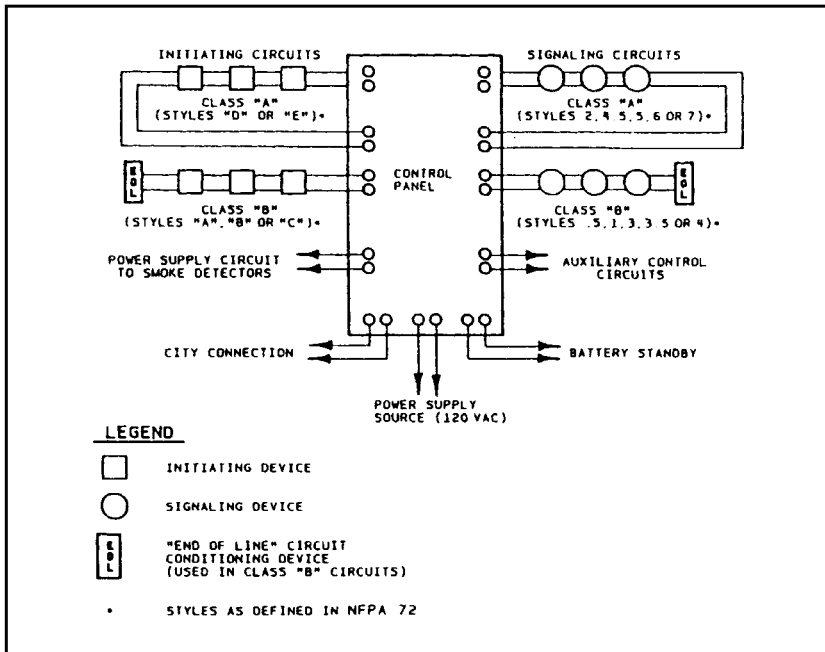

ing nonsimultaneous single circuit fault conditions as specified by the following:

1. Circuits capable of transmitting an alarm signal during a single open or a nonsimultaneous single ground fault on a circuit conductor shall be designated as Class A.
2. Circuits not capable of transmitting an alarm beyond the location of the fault conditions specified in the preceding entry shall be designated as Class B.

Faults on both Class A and Class B circuits shall result in a trouble condition on the system in accordance with the requirements of NFPA 72, Article 1-5.8.

Style

Initiating device, notification appliance, and signaling line circuits shall be permitted to be designated by style also, depending on the capability of the circuit to transmit alarm and trouble signals during specified simultaneous multiple circuit fault conditions in addition to the single circuit fault conditions considered in the designation of the circuits by class.

1. An initiating device circuit shall be permitted to be designated as Style A, B, C, D, or E, depending on its ability to meet the alarm and trouble performance requirements shown in Table 7.1, during a single open, single ground, wire-to-wire short, or loss of carrier fault condition.
2. A notification appliance circuit shall be permitted to be designated as Style W, X, Y, or Z, depending on its ability to meet the alarm and trouble performance requirements shown in Table 7.2, during a single open, single ground, or wire-to-wire short fault condition.
3. A signaling line circuit shall be permitted to be designated as Style 0.5, 1, 2, 3, 3.5, 4, 4.5, 5, 6, or 7, depending on its ability to meet the alarm and trouble performance requirements shown in Table 7.3, during a single open, single ground, wire-to-wire short, simultaneous wire-to-wire short and open, simultaneous wire-to-wire short and ground, simultaneous open and ground, or loss of carrier fault condition.

Installation of Class A Circuits

All styles of Class A circuits using physical conductors (e.g., metallic, optical fiber) shall be installed such that the outgoing and return conductors exiting from and returning to the control unit, respectively, are routed separately. The outgoing and return (redundant) circuit conduc-

TABLE 7.1 Performance of Initiating Device Circuits (IDC)

Class Style	B			B			B			A			A		
	A			B			C			D			E α		
	Alarm	Trouble	Alarm receipt capability during abnormal condition	Alarm	Trouble	Alarm receipt capability during abnormal condition	Alarm	Trouble	Alarm receipt capability during abnormal condition	Alarm	Trouble	Alarm receipt capability during abnormal condition	Alarm	Trouble	Alarm receipt capability during abnormal condition
Abnormal Condition	1	2	3	4	5	6	7	8	9	10	11	12	13	14	15
A. Single open		X			X			X			X	X		X	X
B. Single ground		R			X	R		X	R		X	R		X	R
C. Wire-to-wire short	X			X				X		X				X	
D. Loss of carrier (if used)/channel interface								X						X	

TABLE 7.2 Notification Appliance Circuits (NAC)

Class	B		B		B		A	
Style	W		X		Y		Z	
X = Indication required at protected premises	Trouble indication at protected premises		Trouble indication at protected premises		Trouble indication at protected premises		Trouble indication at protected premises	
	Alarm capability during abnormal conditions		Alarm capability during abnormal conditions		Alarm capability during abnormal conditions		Alarm capability during abnormal conditions	
Abnormal condition	1	2	3	4	5	6	7	8
Single open	X		X	X	X		X	X
Single ground	X		X		X	X	X	X
Wire-to-wire short	X		X		X		X	

tors shall not be run in the same cable assembly (i.e., multiconductor cable), enclosure, or raceway.

Exception No. 1: For a distance not to exceed 10 ft (3 m) where the outgoing and return conductors enter or exit the initiating device, notification appliance, or control unit enclosures; or

Exception No. 2: Where the vertically run conductors are contained in a 2-h rated cable assembly or enclosed (installed) in a 2-h rated enclosure other than a stairwell; or

Exception No. 3: Where permitted and where the vertically run conductors are enclosed (installed) in a 2-h rated stairwell in a building fully sprinklered in accordance with NFPA 13, Standard for the Installation of Sprinkler Systems.

Exception No. 4: Where looped conduit/raceway systems are provided, single conduit/raceway drops to individual devices or appliances shall be permitted.

TABLE 7.3 Performance of Signaling Line Circuits (SLC)

Class	B		B		A		B		B		B		B		A		A		A											
	Style		0.5		1		2α		3		3.5		4		4.5		5α		6α		7α									
M = May be capable of alarm with wire-to-wire short	Alarm	Trouble	Alarm	Alarm	Alarm	Alarm	Alarm	Alarm	Alarm	Alarm	Alarm	Alarm	Alarm	Alarm	Alarm	Alarm	Alarm	Alarm	Alarm	Alarm	Alarm									
R = Required capability																														
X = Indication required at protected premises and as required by Chapter 4																														
α = Style exceeds minimum requirements for Class A																														
Abnormal Condition	1	2	3	4	5	6	7	8	9	10	11	12	13	14	15	16	17	18	19	20	21	22	23	24	25	26	27	28	29	30
A. Single open	X			X			X	R		X			X			X		X	R		X	R		X	R		X	R		
B. Single ground	X			X	R		X	R		X	R		X			X	R		X		X	R		X	R		X	R		
C. Wire-to-wire short									M	X			X			X		X			X		X		X		X	R		
D. Wire-to-wire short & open									M	X			X			X		X			X		X		X		X			
E. Wire-to-wire short & ground								X	M	X			X			X		X			X		X		X		X			
F. Open and ground								X	R	X			X			X		X			X		X	X		X	X		R	
G. Loss of carrier (if used)/ channel interface													X			X		X			X		X		X		X			

Exception No. 5: Where looped conduit/raceway systems are provided, single conduit/raceway drops to multiple devices or appliances installed within a single room not exceeding 1000 ft² (92.9 m²) in area shall be permitted.

Performance of Initiating Device Circuits (IDC)

The assignment of class designations or style designations, or both, to initiating circuits shall be based on their performance capabilities under abnormal (fault) conditions in accordance with the requirements of Table 7.1.

Performance of Signaling Line Circuits (SLC)

The assignment of class designations or style designations, or both, to signaling line circuits shall be based on their performance capabilities under abnormal (fault) conditions in accordance with the requirements of Table 7.2.

Notification Appliance Circuits (NAC)

The assignment of class designations or style designations, or both, to notification appliance circuits shall be based on their performance capabilities under abnormal (fault) conditions in accordance with the requirements of Table 7.3.

Secondary Supply Capacity and Sources

From NFPA 72, Chapter 1 (“Fundamentals”), the secondary source for a protected premises system should have a secondary supply source capacity of 24 h; and at the end of that period shall be capable of operating all alarm notification appliances used for evacuation or to direct aid to the location of an emergency for 5 min. The secondary power supply for emergency voice/alarm communications service shall be capable of operating the system under maximum load for 24 h and then shall be capable of operating the system during a fire or other emergency condition for a period of 2 h. Fifteen minutes of evacuation alarm operation at maximum connected load shall be considered the equivalent of 2 h of emergency operation.

Audible/Visual Notification Appliance Requirements

The tables that follow summarize the audible and visual notification appliance requirements to comply with the American with Disabilities Act Accessibility Guidelines (ADAAG), NFPA 72-1993 and BOCA-1993. Also, refer to Fig. 7.2 for the mounting heights of manual pull stations.

TABLE 7.4 Audible Notification Appliances to Meet the Requirements of: ADA, NFPA 72 (1993), BOCA

ADA	NFPA	BOCA
<ul style="list-style-type: none"> • Intensity and frequency that can attract individuals who have partial hearing loss • Periodic element to its signal such as: <ul style="list-style-type: none"> • Single stroke bell • Hi-Low • Fast whoop • Avoid continuous or reverberating tones. Select a signal which has a sound characterized by three or four clear tones without a great deal of noise in between. 	<ul style="list-style-type: none"> • To insure that audible public mode signals are clearly heard, it shall be required that their sound level be at least 15 dBA above the average ambient sound level, or 5 dBA above the maximum sound level having a duration of at least 60 seconds, whichever is greater, measured at 5' above the floor in the occupiable area • Mechanical Equipment Rooms <ul style="list-style-type: none"> • Design for a minimum of 85 dBA for all type occupancies • Sleeping Areas <ul style="list-style-type: none"> • Design for a minimum of 70 dBA at any point in the sleeping area • Mounting location <ul style="list-style-type: none"> • Wall mounted appliances <ul style="list-style-type: none"> -not less than 90" AFF -not less than 6" BFC • Combination A/V Units <ul style="list-style-type: none"> -Bottoms 80"- 96" AFF • Effective July 1, 1996, the fire alarm signal used to notify building occupants shall be in accordance with ANSI S3.41 (NFPA 3-7.2) • Temporal Slow Whoop <u>or</u> • Temporal Code 3-3, 1 second bursts of signal with 2 seconds quiet before repeating the 3 bursts 	<ul style="list-style-type: none"> • Minimum of 15 dBA over average ambient • Every occupied space within the building • Minimum of 70 dBA in use groups R, I-1 • Minimum of 90 dBA in Mechanical Rooms • Minimum of 60 dBA in all other use groups • Maximum of 130 dBA at minimum hearing distance from audible appliance

Design Criteria	Design Comments	Available Devices
<ul style="list-style-type: none"> • Ratings/listings - most devices are rated for dBA output at 10' from device; • Doubling the distance from the device - drop of 6 dBA <ul style="list-style-type: none"> • A device with an output of 96 dBA at 10' will have 90 dBA at 20', 84 dBA at 40', 78 dBA at 80', etc. • Acoustic tile ceiling causes approximately a 3 dBA drop in sound levels; • Rug on floor - causes approximately 3 dBA drop in sound levels; • An open door: 8-12 dBA drop; • Closed hollow core door: 12-20 dBA drop; • Closed solid core, rated door: 20-30 dBA drop; • 4" Partition: 40-45 dBA drop; • Multiple signals effect: add approximately 3 dBA at mid-point of signals; <p><u>Typical ambient sound levels:</u></p> <ul style="list-style-type: none"> • High School Office: 60 dBA • Corridor with back- ground music: 60 dBA • Classroom with students "Under Control": 62 dBA • Classroom with TV set turned on: 65 dBA • Classroom with students "out of control" end of day: 70 dBA • Corridor with students at end of day: 80 dBA • Normal Business Office: 55 to 60 dBA (air diff., computer on, 1 person talking on phone) • Hotel Room with A/C unit running in room and TV turned on: 65 dBA 	<ul style="list-style-type: none"> • It is good fire alarm system design engineering to provide audible devices that allow for adjusting their sound level output to accommodate the sound level environment they are installed in; • "OVER KILL" in dBA output can be a disaster for the END USER (installing horns, mini-horns in all spaces) • No more than one type of Fire Alarm Signaling Device may be used in an area (PA Labor & Industry). All audible alarm notification appliance devices in a facility shall be distinguishable from all other audible devices in the building (BOCA): • Horns or bells in the corridor and buzzers in the rooms may not meet this criteria; • Under most circumstances, the only practical way to achieve the required sound level to meet the ADA and applicable codes, is to install an audible notification appliance in every room and occupied space in the facility • Presently, the only practical approved audible device available, with a wide range of dBA adjustments to meet these requirements is the Fire Alarm Speaker. • Present technology allows tones to be generated on the speakers to meet the desired sound characteristics 	<p><u>Fire Alarm Horn</u></p> <ul style="list-style-type: none"> • Ratings from 88 dBA to 110 dBA • Settings of "loud to louder" • Normally mid to high frequency • Multi-tone settings in field available • Relatively low current draw • Low profile - standard mounting • Low to moderate price <p><u>Fire Alarm Bell</u></p> <ul style="list-style-type: none"> • Ratings of 87 dBA to 92 dBA • Output not adjustable • Low to mid range frequency • Low current draw • Approximate same cost as a horn • Surface mounting • Large in size than a horn <p><u>Fire Alarm Speakers</u></p> <ul style="list-style-type: none"> • Ratings from 75 dBA to 120 dBA • Wide range of adjustment • Frequency of low to high • Flush and surface mount • Slightly higher cost when supplied with variable taps <p><u>Speakers</u></p> <ul style="list-style-type: none"> • Speakers are available with outputs adjustable from 75 dBA to 120 dBA • A common tone can be generated at the main control and amplified and distributed to all speaker circuits • Emergency paging can normally be added as an option • Speakers can be re-taped if changes in ambient sound level occur in the area they are installed in • Design circuits to a maximum of 75% to 80% of rated capacity to allow for ambient sound level changes

TABLE 7.5 Visual Notification Appliances to Meet the Requirements of: ADA, NFPA 72 (1993), BOCA

ADA		ADA (continued)	
<ul style="list-style-type: none"> • Xenon strobe or equivalent • Clear or nominal white lens color • Minimum of 75 candelas or equivalent facilitation • 1 to 3 Hz flash rate • 80" AFF or 6" BFC • No place in any room or space required to have a visual signal shall be more than 50' from the visual signal • In large open spaces, such as auditoriums exceeding 100' across, mount 6' AFF, spaced a maximum of 100' apart • No place in corridors or hallways shall be more than 50' from a visual signal • Install in restrooms, general use areas, meeting rooms, hallways, lobbies and other common use area • ADA does not mandate emergency alarm systems • In existing buildings, the update of the fire alarm system requires ADA compliance • Common Use areas include: <ul style="list-style-type: none"> • Meeting and conference rooms • Employee break rooms • Classrooms • Cafeterias • Filing and photocopy rooms • Dressing rooms • Examination rooms • Treatment rooms • Similar space not used solely as employee work areas 		<ul style="list-style-type: none"> • Not required in individual offices and work stations • Visual units not required in: <ul style="list-style-type: none"> • Mechanical, electrical, telephone rooms • Janitor's closets • Similar non-occupiable spaces • Non-assigned work areas • Lamps tested at 1/3 Hz were judged ineffective. Requires a flash rate of from 1 to 3 Hz • Mounting heights from 80" to 96" AFF are considered equivalent • Recommend 100' spacing in corridors and installed on alternate walls • Maximize lamp intensity to minimize number of fixtures • Lesser intensity may be sufficient as an equivalent facilitation • Equivalent facilitation permits alternate designs • Where a single lamp can provide the necessary intensity and coverage, multiple lamps should not be installed because of their potential effect on persons with photosensitivity • Health Care Facilities: modify to suit industry-accepted practices (NFPA 101). <p><u>Mounting Heights</u></p> <ul style="list-style-type: none"> • Forward Reach: 15"-48" AFF • Side Reach: 9"-54" AFF 	
<p>UL 1971</p> <ul style="list-style-type: none"> - 1/3 Hz rate - Allows ceiling mount. - 15 cd corridor units 		<p>ADA</p> <ul style="list-style-type: none"> - 1 to 3 Hz rate - No ceiling mounting - Equivalent facilitation 	
NFPA	BOCA	Design Criteria	Design Comments
<ul style="list-style-type: none"> • NFPA accepts the requirements of UL 1971 to determine compliance for visual units; • It is important to determine if the system is designed to meet the ADA or UL 1971 Guidelines <p><u>Mounting Heights</u></p> <ul style="list-style-type: none"> • Minimum of 42" - Maximum of 54" 	<ul style="list-style-type: none"> • Required in public and common areas of all buildings housing the hearing impaired. • In Use Groups I-1 and R-1, in required accessible sleeping rooms and suites. • Sleeping room visual units shall be activated by the in-room smoke detector and building fire alarm system <p><u>Mounting Heights</u></p> <ul style="list-style-type: none"> • Minimum of 42" - Maximum of 54" 	<ul style="list-style-type: none"> • Synchronization of strobes when more than two strobes are installed in the same room • Keep tuned: ADA is considering changes <p><u>Mounting Heights</u></p> <ul style="list-style-type: none"> • PAL&I - Minimum of 36"-Maximum of 44" 	<ul style="list-style-type: none"> • Check with the strobe manufacturer's data sheets to determine coverage and compliance with the ADA for corridor strobes. • Some manufacturer's 15 cd strobes may be spaced 100' apart in corridors; others require closer spacing.

Manual Pull Stations—Mounting Heights

FIGURE 7.2 (a) High forward reach limit. (b) High and low side reach limits.

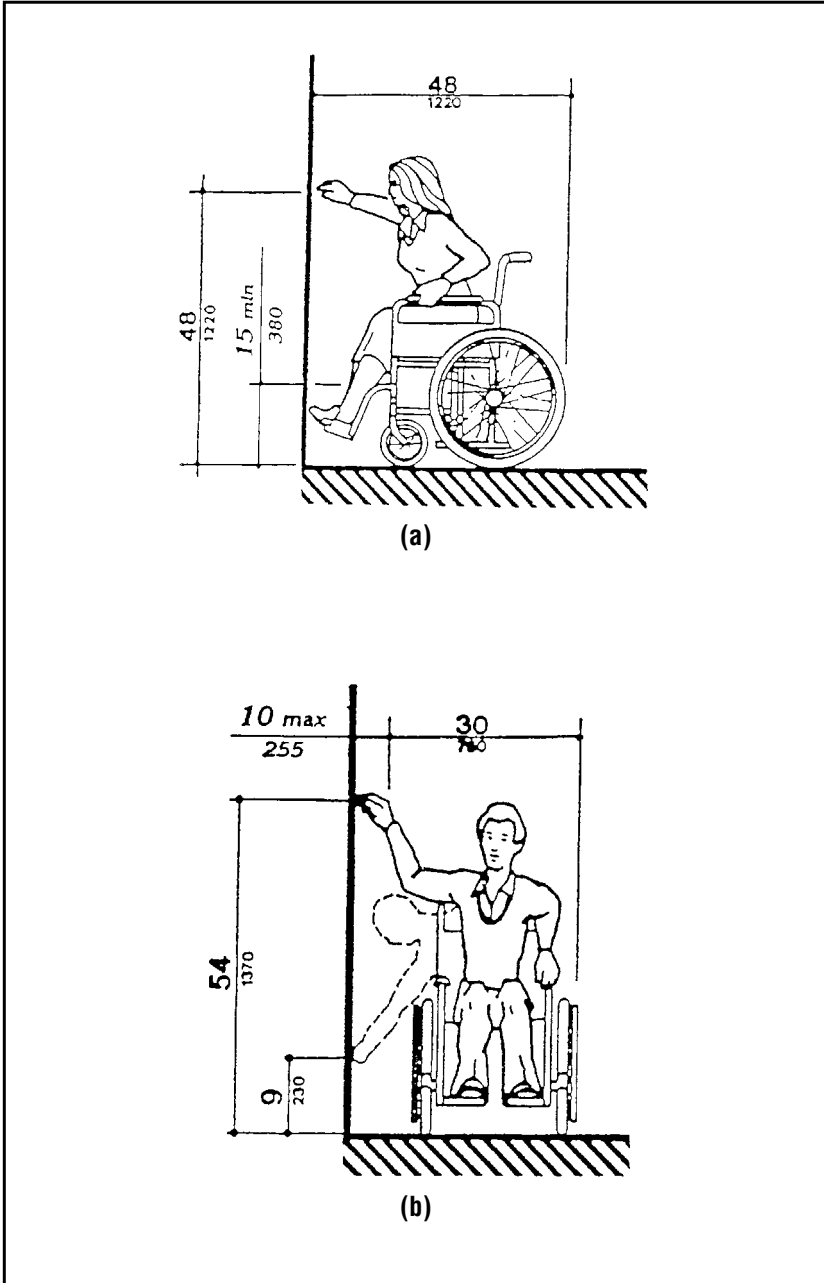

Application Tips

A very general rule of thumb for spacing automatic fire detectors is to allow 900 ft² per head. This is good for very rough estimating in preliminary stages of design. There are many factors to consider for each specific application, for instance architectural and structural features such as beams and coves, special-use spaces, and ambient temperature and other environmental considerations. It is therefore prudent to refer to and become familiar with NFPA 72, Appendix B (“Application Guide for Automatic Fire Detector Spacing”) coupled with your own experience.

In the design of any fire alarm system, it is necessary to determine what codes and other requirements are applicable to the project site, as well as what editions of same have been adopted and are in effect at the time of design (sometimes states and/or municipalities don't adopt the latest edition of codes until several years later), and it is good practice to review the design with the AHJ periodically throughout the design process. This latter step will also be beneficial in resolving any conflicts between codes and the ADAAG (these do occur) through equivalent facilitation, thus achieving compliance with all codes and regulations that apply.

It is also essential to coordinate with the architect, structural engineer, and other trade disciplines (e.g., sprinkler systems) to determine their effects on fire alarm system requirements.

Fire alarm system technology today has reached a profoundly high level, with multiplexed digital communication, 100 percent addressable systems, and even “smart” automatic fire detectors that can be programmed with profiles of their ambient environmental conditions, thus preventing nuisance alarms by being able to discriminate between normal and abnormal conditions for their specific environment. These capabilities provide the designer with a lot of flexibility to design safe and effective fire alarm systems.

7.2 TELECOMMUNICATIONS STRUCTURED CABLING SYSTEMS

Structured Cabling Design

Structured cabling is a term widely used to describe a generic voice, data, and video (telecommunications) cabling system design that supports a multiproduct, multivendor, and multimedia environment. It is an information technology (IT) infrastructure that provides direction for the cabling system design based on the end user's requirements, and it enables cabling installations where there is little or no knowledge of the active equipment to be installed.

The following provides an overview of the industry standards.

Important Codes and Standards

- American National Standards Institute (ANSI)
- Canadian Standards Association (CSA)
- Comité Européen de Normalisation Electrotechnique (CENELEC)
- Federal Communications Commission (FCC)
- Insulated Cable Engineers Association (ICEA)
- International Electrotechnical Commission (IEC)
- Institute of Electrical and Electronics Engineers, Inc. (IEEE)
- International Organization for Standardization (ISO)
- International Organization for Standardization/International Electrotechnical Commission Joint Technical Committee Number 1 (ISO/IEC JTC1)
- U.S. National Fire Protection Association (NFPA)
- National Research Council of Canada, Institute for Research in Construction (NRC-IRC)
- Telecommunications Industry Association/Electronic Industries Alliance (TIA/EIA)

Comparison of ANSI/TIA/EIA, ISO/IEC, and CENELEC Cabling Standards (see Table 7.6)

Major Elements of a Telecommunications Structured Cabling System

- Horizontal pathway systems
- Horizontal cabling systems
- Backbone distribution systems
- Backbone building pathways
- Backbone building cabling
- Work areas (WAs)
- Telecommunications outlets (TOs)
- Telecommunications rooms (TRs)
- Equipment rooms (ERs)
- Telecommunications entrance facilities (EFs)

The data that follows provides key data and details for these major elements.

TABLE 7.6*

	ANSI/TIA/EIA-568-A, TSBs and addenda	ISO/IEC 11801:1995 and amendments	CENELEC EN 50173:1995 and amendments
100 ohm balanced cable	Supported	Supported	Supported
120 ohm balanced cable	Not supported	Supported	Supported
150 ohm STP cable	Supported ¹	Supported ¹	Supported ¹
50/125 μm multimode fiber	Not supported ²	Supported	Supported
62.5/125 μm multimode fiber	Supported	Supported	Supported
Singlemode fiber	Supported	Supported	Supported
Component categories	Category 3, 4 ³ , 5 ⁴	Category 3, 4 ³ , 5 ⁵	Category 3, 5 ⁵
Link and channel specifications	Category 3, 4 ³ , 5 ⁴ , 5e	Class A, B, C, D ⁵	Class A, B, C, D ⁵
Backbone cable types	100 ohm 150 ohm STP ¹ 62.5 μm fiber ² singlemode fiber	100 or 120 or 150 ¹ ohm (100 ohm preferred) 50 or 62.5 μm fiber (62.5 μm preferred) singlemode fiber	100 or 120 ohm (100 ohm preferred) 50 or 62.5 μm fiber (62.5 μm preferred) singlemode fiber
Horizontal cable types	100 ohm 150 ohm STP ¹ 62.5 μm fiber ² (choice depends on application)	100 or 120 or 150 ¹ ohm (100 ohm preferred) 50 or 62.5 μm fiber (62.5 μm preferred) singlemode fiber	100 or 120 or 150 ¹ ohm (100 ohm preferred) 50 or 62.5 μm fiber (62.5 μm preferred) singlemode fiber

(continued)

* Here, and throughout chapter, indicates that this material is reprinted with permission from BICSI's *Telecommunications Distribution Methods Manual*, 9th edition.

TABLE 7.6* (Continued)

	ANSI/TIA/EIA-568-A, TSBs and addenda	ISO/IEC 11801:1995 and amendments	CENELEC EN 50173:1995 and amendments
TO cable recommendations	1 st TO: 100 ohm (Category 3 minimum) + 2 nd TO: 100 ohm (Category 5 ⁴ required) or 150 ohm STP ¹ or 62.5 μm multimode ²	1 st TO: 100 or 120 ohm (Category 3 minimum) + 2 nd TO: 100 or 120 ohm (Category 5 ⁵ recommended) or 150 ohm STP ¹ or 62.5 μm multimode	1 st TO: 100 or 120 ohm (Category 5 ⁵ recommended) + 2 nd TO: 100 or 120 ohm ^r (Category 5 ⁵ recommended) or 150 ohm STP ¹ or 62.5 μm multimode
Twisted-pair outlet configuration	4 pairs required Configured either T568A or T568B	2 or 4 pairs allowed (4 pairs recommended) Configured pairs to pins	2 or 4 pairs allowed (no preference) Configured pairs to pins
Attenuation of flexible (stranded) cordage	Up to 120% of horizontal cable allowed	Up to 150% of horizontal cable allowed	Up to 150% of horizontal cable allowed
Application mapping	None included ⁶	Comprehensive guidance in Annex G	Guidance in Annex F

¹ STP-A cabling and components will not be recommended for new installations in ANSI/TIA/EIA-568-B.1 and will be deleted from the next editions of ISO/IEC 11801 and EN 50173. Requirements for 100 ohm ScTP are provided in TIA/EIA IS 729.

² Requirements for 50/125 μm fiber will be specified in ANSI/TIA/EIA-568-B.1.

³ Category 4 requirements will not be provided in ANSI/TIA/EIA-568-B.1 or in the next edition of ISO/IEC 11801.

⁴ Specifications for Category 5 cabling and components will be replaced by Category 5e in ANSI/TIA/EIA-568-B.1 and ANSI/TIA/EIA-568-B.2. Category 5 values will be provided for information only.

⁵ ISO/IEC and CENELEC Category 5 and Class D requirements will be aligned with TIA Category 5e component and cabling specifications in the next editions of ISO/IEC 11801 and EN 50173.

⁶ ANSI/TIA/EIA-568-B.1 will provide application mapping for optical fiber cabling.

Typical Ranges of Cable Diameter

TABLE 7.7*

Horizontal Cable Type	Typical Range of Overall Diameter
4-pair 100 Ω UTP or ScTP (FTP)	3.6 mm to 6.3 mm (0.14 in to 0.25 in)
2-fiber optical cable	2.8 mm to 4.6 mm (0.11 in to 0.18 in)
4-pair 100 Ω STP	7.9 mm to 11 mm (0.31 in to 0.43 in)

NOTES: FTP = Foiled twisted-pair STP = Shielded twisted-pair
 ScTP = Screened twisted-pair UTP = Unshielded twisted-pair

Conduit Sizing—Number of Cables

TABLE 7.8*

Inside Diameter mm	Trade Size	Cable Outside Diameter mm (in)									
		3.3 (0.13)	4.6 (0.18)	5.6 (0.22)	6.1 (0.24)	7.4 (0.29)	7.9 (0.31)	9.4 (0.37)	13.5 (0.53)	15.8 (0.62)	17.8 (0.70)
16	1/2	1	1	0	0	0	0	0	0	0	0
21	3/4	6	5	4	3	2	2	1	0	0	0
27	1	8	8	7	6	3	3	2	1	0	0
35	1-1/4	16	14	12	10	6	4	3	1	1	1
41	1-1/2	20	18	16	15	7	6	4	2	1	1
53	2	30	26	22	20	14	12	7	4	3	2
63	2-1/2	45	40	36	30	17	14	12	6	3	3
78	3	70	60	50	40	20	20	17	7	6	6
91	3-1/2							22	12	7	6
103	4							30	14	12	7

NOTE: These conduit sizes are typical in the United States and Canada, and may vary in other countries.

Bend Radii Guidelines for Conduits

TABLE 7.9*

If the Conduit Has an Internal Diameter of...	The Bend Radius Must Be at Least...
50 mm (2 in) or less	6 times the internal conduit diameter.
More than 50 mm (2 in)	10 times the internal conduit diameter.

NOTE: For additional information on conduit bend radius requirements and recommendations in the United States, see specifications in the *NEC* (Chapter 9) and *ANSI/TIA/EIA-569-A*, (Chapter 5, Table 5.2-1). In Canada, refer to *CSA-C22.1* (Sections 12-900 through 12-2502) and *CSA-T530*. These specifications provide bend radius guidelines for standard trade-size conduits.

Guidelines for Adapting Designs to Conduits with Bends

TABLE 7.10*

If a Conduit Run Requires...	Then...
More than two 90 degree bends	Provide a pull box (PB) between sections with two bends or less.
A reverse bend (between 100 degree and 180 degree)	Insert a pull point or PB at each bend having an angle from 100 degree to 180 degree.
A third 90 degree bend (between pull points or PBs)	For this additional bend, derate the design capacity by 15 percent.

NOTE: Consider an offset as equivalent to a 90 degree bend.

Recommended Pull Box Configurations

FIGURE 7.3* Recommended Pull Box Configurations

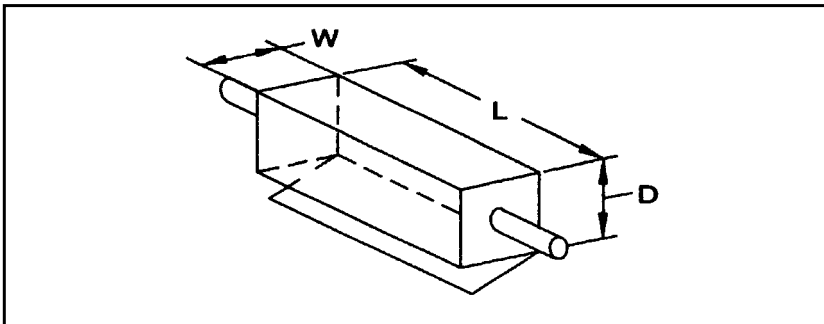
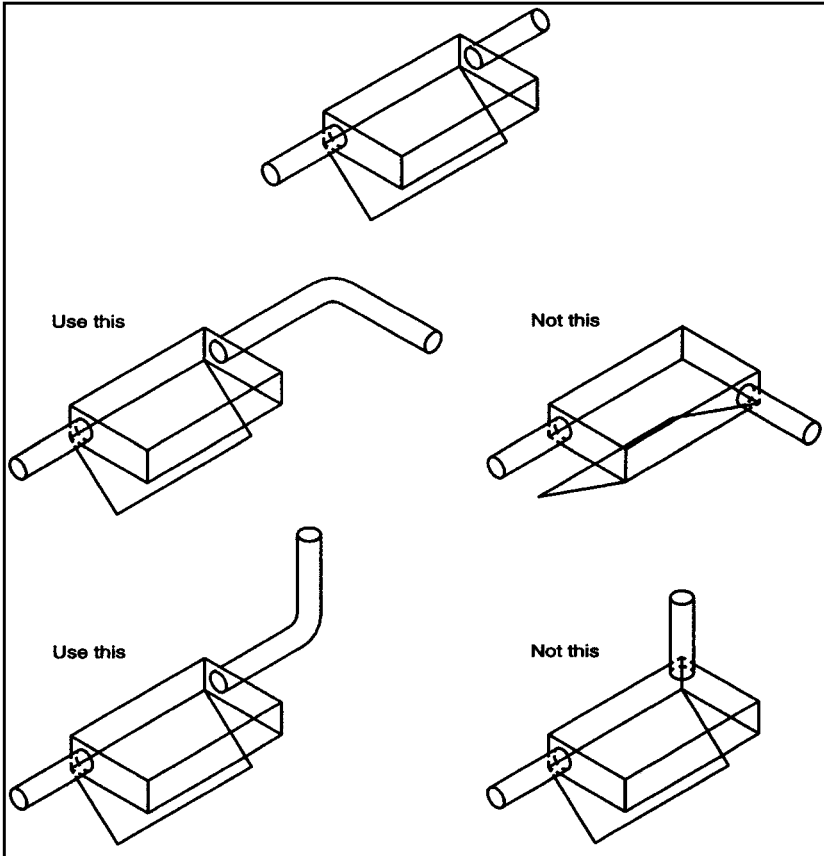

Minimum Space Requirements in Pull Boxes Having One Conduit Each in Opposite Ends of the Box

TABLE 7.11*

Maximum Trade Size of Conduit	Size of Box			For Each Additional Conduit Increase Width
	Width	Length	Depth	
21 mm (3/4)	100 mm (4 in)	300 mm (12 in)	75 mm (3 in)	50 mm (2 in)
27 mm (1)	100 mm (4 in)	400 mm (16 in)	75 mm (3 in)	50 mm (2 in)
35 mm (1-1/4)	150 mm (6 in)	500 mm (20 in)	75 mm (3 in)	75 mm (3 in)
41 mm (1-1/2)	200 mm (8 in)	675 mm (27 in)	100 mm (4 in)	100 mm (4 in)
53 mm (2)	200 mm (8 in)	900 mm (36 in)	100 mm (4 in)	125 mm (5 in)
63 mm (2-1/2)	250 mm (10 in)	1050 mm (42 in)	125 mm (5 in)	150 mm (6 in)
78 mm (3)	300 mm (12 in)	1200 mm (48 in)	125 mm (5 in)	150 mm (6 in)
91 mm (3-1/2)	300 mm (12 in)	1350 mm (54 in)	150 mm (6 in)	150 mm (6 in)
103 mm (4)	375 mm (15 in)	1520 mm (60 in)	200 mm (8 in)	200 mm (8 in)

Cable Tray Dimensions (Common Types)

TABLE 7.12*

	Ladder	Ventilated Trough	Ventilated Channel	Solid-Bottom
Lengths	3.7 m (12 ft) 7.3 m (24 ft)	3.7 m (12 ft) 7.3 m (24 ft)	3.7 m (12 ft) 7.3 m (24 ft)	3.7 m (12 ft) 7.3 m (24 ft)
Widths (Inside)	150 mm (6 in) 300 mm (12 in) 450 mm (18 in) 600 mm (24 in) 750 mm (30 in) 900 mm (36 in)	150 mm (6 in) 300 mm (12 in) 450 mm (18 in) 600 mm (24 in) 750 mm (30 in) 900 mm (36 in)	75 mm (3 in) 100 mm (4 in) 150 mm (6 in) — — — — — —	150 mm (6 in) 300 mm (12 in) 450 mm (18 in) 600 mm (24 in) 750 mm (30 in) 900 mm (36 in)
NOTE: The side rail outside depths (height) can be as much as 32 mm (1-1/4 in) more than the inside loading depth for ladder, ventilated trough, and solid bottom cable tray.				
Depths	75 mm (3 in) 100 mm (4 in) 125 mm (5 in) 150 mm (6 in)	75 mm (3 in) 100 mm (4 in) 125 mm (5 in) 150 mm (6 in)	32 mm (1-1/4 in) 45 mm (1-3/4 in) — — — —	75 mm (3 in) 100 mm (4 in) 125 mm (5 in) 150 mm (6 in)
Rung spacing	150 mm (6 in) 225 mm (9 in) 300 mm (12 in) 450 mm (18 in)	— — — — — — — —	— — — — — — — —	— — — — — — — —
Radii	300 mm (12 in) 600 mm (24 in) 900 mm (36 in)	300 mm (12 in) 600 mm (24 in) 900 mm (36 in)	300 mm (12 in) 600 mm (24 in) 900 mm (36 in)	300 mm (12 in) 600 mm (24 in) 900 mm (36 in)
Degrees of arc	30° 45° 60° 90°	30° 45° 60° 90°	30° 45° 60° 90°	30° 45° 60° 90°
Transverse element spacing	— —	100 mm (4 in)	— —	— —

Topology

ANSI/EIA/TIA-568A specifies a star topology—a hierarchical series of distribution levels. Each WA outlet must be cabled directly to a horizontal cross-connect {HC [floor distributor (FD)]} in the telecommunications room (TR) except when a consolidation point (CP) is required

to open office cabling or a transition point (TP) is required to connect undercarpet cable. Horizontal cabling should be terminated in a TR that is on the same floor as the area being served.

NOTES Splices are not permitted for twisted-pair horizontal cabling.
Bridged taps (multiple appearances of the same cable pairs at several distribution points) are not permitted in horizontal cabling.

Cabling between TRs is considered part of the backbone cabling. Such connections between TRs may be used for configuring virtual bus and virtual ring cabling schemes using a star topology.

Horizontal Cabling to Two Individual Work Areas

FIGURE 7.4* Horizontal Cabling to Two Individual Work Areas

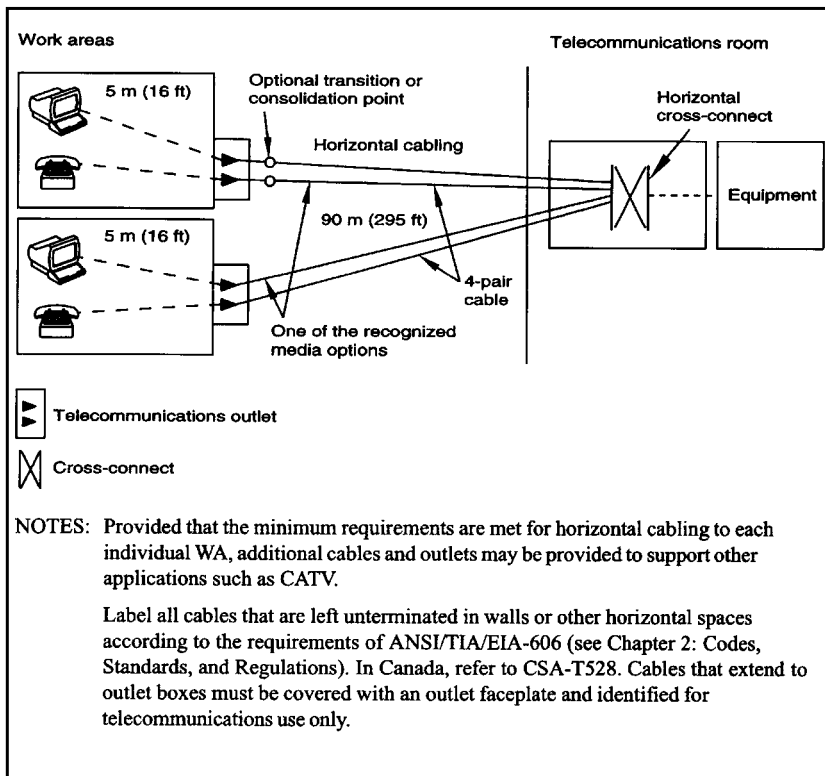

Cable Lengths

TABLE 7.13*

Horizontal Cables...	Must Be No More Than...
From the HC (FD) to the outlet/connector	90 m (295 ft) long.
Used for patch cords and cross-connect jumpers in the HC (FD)	5 m (16 ft) long. (See Note.)

NOTE: In establishing limits on horizontal cable lengths, a 10 m (33 ft) allowance was made for the combined length of patch cords and cables used to connect equipment in the WA and TR. All equipment cords should meet the same performance requirements as the patch cords. Equipment cords differ from patch cables and cross-connect jumpers in that they attach directly to active equipment; patch cords and cross-connect jumpers do not attach directly to active equipment.

Twisted-Pair (balanced) Cabling Categories

TABLE 7.14*

Category	Definition
Category 3	<p>This category consists of cables and connecting hardware specified up to 16 MHz.</p> <p>The performance of Category 3 cabling links corresponds to application Class C links as originally specified in ISO/IEC 11801 and CENELEC EN 50173.</p>
Category 5	<p>This category consists of cables and connectors specified up to 100 MHz.</p> <p>The performance of Category 5 cabling links corresponds to application Class D links as originally specified in ISO/IEC 11801 and CENELEC EN 50173.</p>
Category 5e	<p>This category consists of cables and connectors specified up to 100 MHz.</p> <p>Category 5e transmission performance of Category 5e cabling is specified in ANSI/TIA/EIA-568-A-5 and is intended to support applications that use more than one pair to transmit in each direction.</p>
Category 6	<p>This category consists of cables and connectors specified up to 250 MHz.</p> <p>The performance of Category 6 cabling links corresponds to application Class E links to be specified in ISO/IEC 11801 and CENELEC EN 50173.</p>
Category 7	<p>This category consists of shielded cables and connectors specified up to 600 MHz.</p> <p>The performance of Category 7 cabling links corresponds to application Class F links to be specified in ISO/IEC 11801 and CENELEC EN 50173.</p>

NOTES:

Categories 1 and 2 are not recognized cables.

Category 4 is not recommended.

Categories 3 and 5e meet ANSI/TIA/EIA-568-B.1 and B.2.

Categories 6 and 7 specifications are under development in TIA and ISO/IEC.

Optical Fiber Cable Performance

TABLE 7.15* Equipment Room Floor Space (Special-Use Buildings)

Fiber Type	Fiber Performance
62.5/125 μm	Minimum bandwidth of 160 and 500 MHz • km at 850 and 1300 nm respectively.
50/125 μm	Minimum bandwidth of 500 and 500 MHz • km at 850 and 1300 nm respectively.

Twisted-Pair Work Area Cable

FIGURE 7.5* Twisted-Pair Work Area Cable

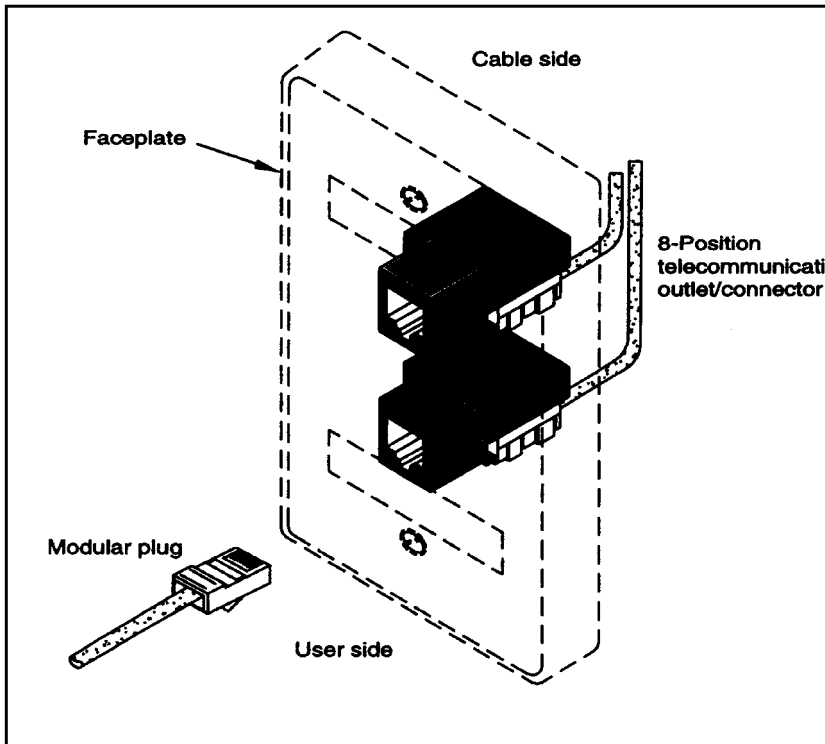

**Eight-Position Jack Pin/Pair Assignments (TIA-568A)
(Front View of Connector)**

FIGURE 7.6* Eight-Position Jack Pin/Pair Assignments (TIA-568A)
(Front View of Connector)

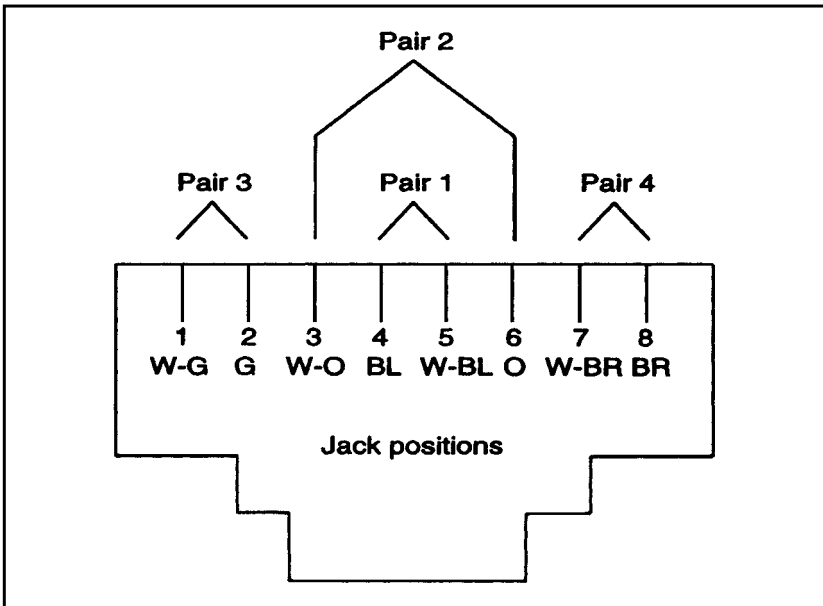

**Optional Eight-Position Jack Pin/Pair Assignments (TIA-568B)
(Front View of Connector)**

FIGURE 7.7* Optional Eight-Position Jack Pin/Pair Assignments (TIA-568B) (Front View of Connector)

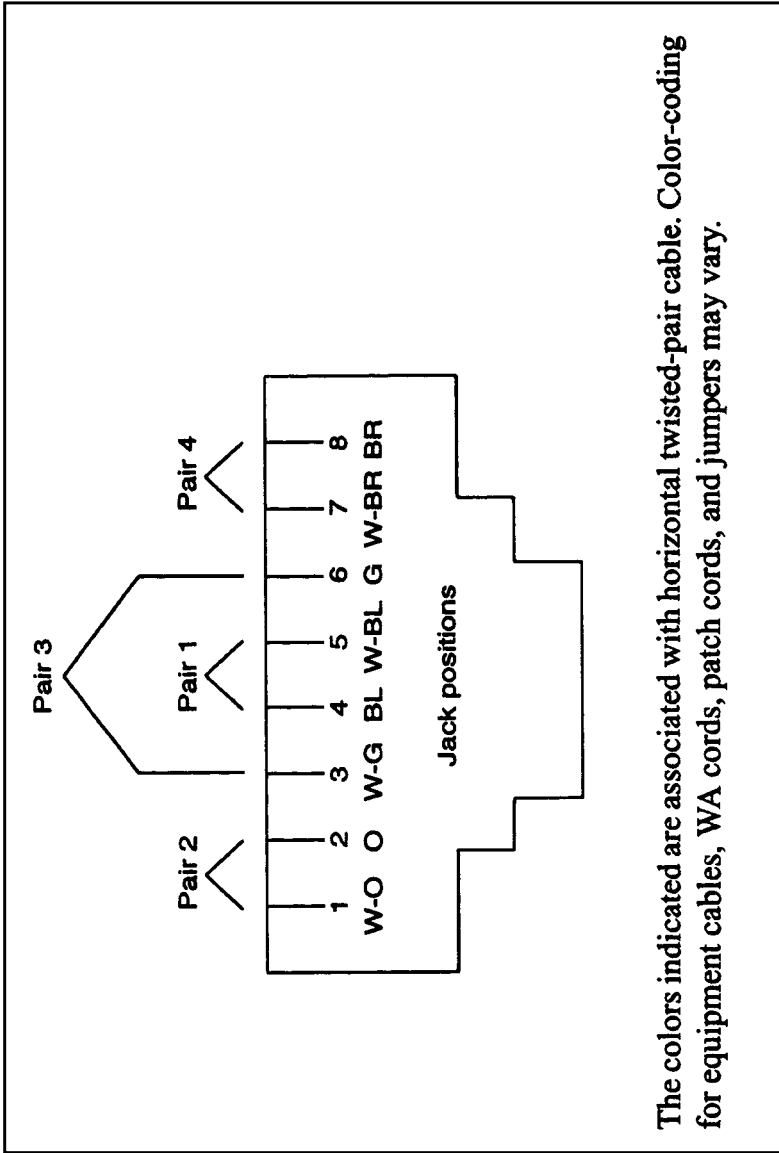

The colors indicated are associated with horizontal twisted-pair cable. Color-coding for equipment cables, WA cords, patch cords, and jumpers may vary.

Termination Hardware for Category-Rated Cabling Systems

TABLE 7.16*

Termination Hardware	Category 3	Category 4	Category 5
Screw terminals	(1)	–	–
25 pair connector	(2)	(2)	(2)
66-clip	Yes	Yes	(2)
110	Yes	Yes	Yes
Krone®	Yes	Yes	(2)
BIX®	Yes	Yes	(2)

Note (1): If the application specifically requires it.

Note (2): Some versions comply; check with the manufacturer.

Patch Cord Wire Color Codes

TABLE 7.17*

Conductor Identification (1)	Wire Color
Pair 1 + Pair 1 -	White (2) Blue (3)
Pair 2 + Pair 2 -	White (2) Orange (3)
Pair 3 + Pair 3 -	White (2) Green (3)
Pair 4 + Pair 4 -	White (2) Brown (3)
<p>Notes: (1) + = Tip, - = Ring (2) Mostly white wire may have the associate color as a band or stripe. (3) Mostly colored wire may have white as a band or stripe.</p>	

ANSI/TIA/EIA-568A Categories of Horizontal Copper Cables (Twisted-Pair Media)

TABLE 7.18*

Designation	Definition
Category 1, 2	These twisted-pair cables are not recognized in the ANSI/TIA/EIA-568-A standard. They are typically used for voice and low speed data (9600 b/s or less) transmission rates.
Category 3	This designation applies to twisted-pair cable and connection hardware currently specified in the ANSI/TIA/EIA-568-A standard. The characteristics of these cables are specified up to 16 MHz. They are typically used for voice and data transmission rates up to 10 Mb/s (e.g., IEEE 802.5 4 Mb/s twisted-pair annex and IEEE 802.3 10BASE-T).
Category 4	The characteristics of these twisted-pair cabling components are specified up to 20 MHz. They are intended to be used for voice and data transmission rates up to and including, 16 Mb/s (e.g., IEEE 802.5 16 Mb/s twisted-pair standard).
Category 5	The characteristics of these twisted-pair cabling components are specified up to 100 MHz. They are intended to be used for voice and data transmission rates up to and greater than, 16 Mb/s (e.g., IEEE 802.5 16 Mb/s twisted-pair standard and ANSI X3T9.5 100 Mb/s twisted-pair physical-media dependent [TP-PMD]).
Category 5e	The characteristics of Category 5e cabling components are specified up to 100 MHz, with additional transmission parameters necessary to support applications that make use of all four pairs in the cable for simultaneous bidirectional transmission (such as IEEE 802.3 1000BASE-T).
Category 6*	Continued development of high-speed applications drove the need for more bandwidth than Category 5e cabling systems. Category 6 channels have a power sum ACR that is greater than zero at 200 MHz, and parameters are specified up to 250 MHz.
Category 7**	Cabling consists of four individually shielded twisted-pairs having nominal impedance of 100 Ω . Category 7 cable requires a new fully-shielded connector design, which is still under development. Category 7 cabling has a bandwidth of 500 MHz (PSACR > 0) and the parameters are specified to 600 MHz.
STP-A	The characteristics of these 150 Ω STP cabling components are specified up to 300 MHz. These cables consist of two individually twisted-pairs of 22 AWG [0.64 mm (0.025 in)] conductors enclosed by a shield and an overall jacket.

* Proposed

** Under consideration in ISO/IEC 11801

Work Area Copper Cable Lengths to a Multi-User Telecommunications Outlet Assembly (MUTOA)

TABLE 7.19*

Length of Horizontal Cables	Maximum Length of Work Area Cords	Maximum Combined Length of Work Area Cords, Patch Cords, and Equipment Cables,
H	W	C
90 m (295 ft)	5 m (16 ft)	10 m (33 ft)
85 m (279 ft)	9 m (30 ft)	14 m (46 ft)
80 m (262 ft)	13 m (44 ft)	18 m (60 ft)
75 m (246 ft)	17 m (57 ft)	22 m (71 ft)
70 m (230 ft)	22 m (71 ft)	27 m (89 ft)

U.S. Twisted-Pair Cable Standards

TABLE 7.20*

Parameter	EIA	IBM	UL	NEMA	Telcordia	ICEA
Published specification	ANSI/TIA/EIA-568-A	GA27-3773-1	200-131A	WC63	TA-NWT-000133	S80-576
Conductor sizes (AWG)	22, 24	22, 24, 26	22, 24	22, 24, 26	24	22, 24, 26
Impedance (ohms)	100	150	100	100, 150	100	Not specified
Cable sizes (Pairs)	4 to 25-Pair Subunits	2 to 6	25 or less	6 or less	Any	3600 or less
Shielding	UTP/STP-A	STP	STP/UTP	STP/UTP	UTP*	STP/UTP
Performance	Category: 1-5e	Type: 1-9	Category: 1-5e	Standard; low loss; low loss extended frequency	Category: 1-5e	Not specified
Equivalence to ANSI/TIA/EIA-568-A	1 2 3 4 5 5e	(none) Type 3 (none) (none) (none)	1 2 3 4 5 5e	(none) (none) Standard low loss low loss, extended frequency	1 2 3 4 5	(none) (none) (none) (none) (none)

* The technical advisory does not preclude STP.

Optical Fiber Sample Connector Types

FIGURE 7.8* Optical Fiber Sample Connector Types

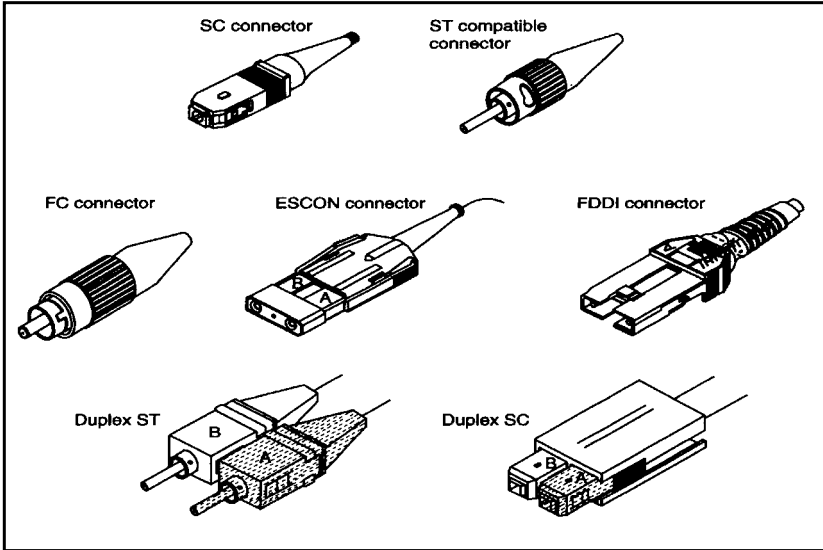

Duplex SC Interface

FIGURE 7.9* Duplex SC Interface

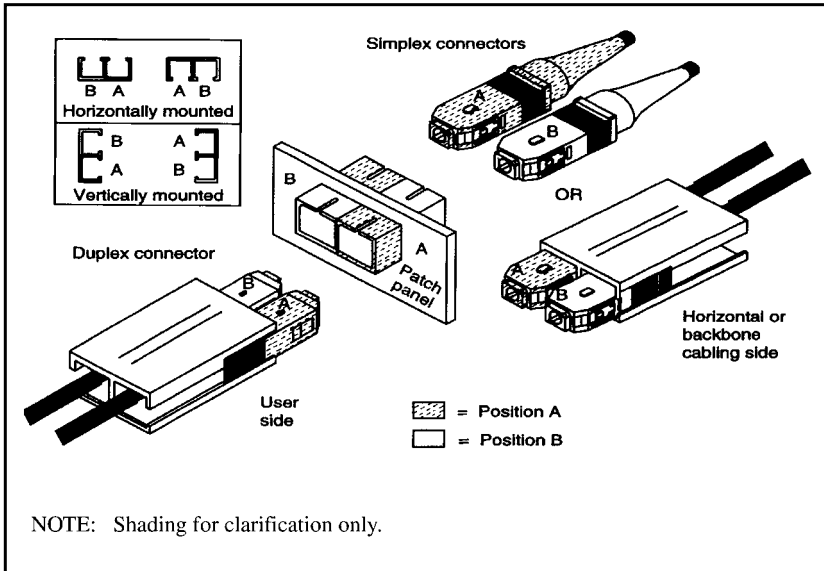

Duplex SC Adapter with Simplex and Duplex Plugs

FIGURE 7.10* Duplex SC Adapter with Simplex and Duplex Plugs

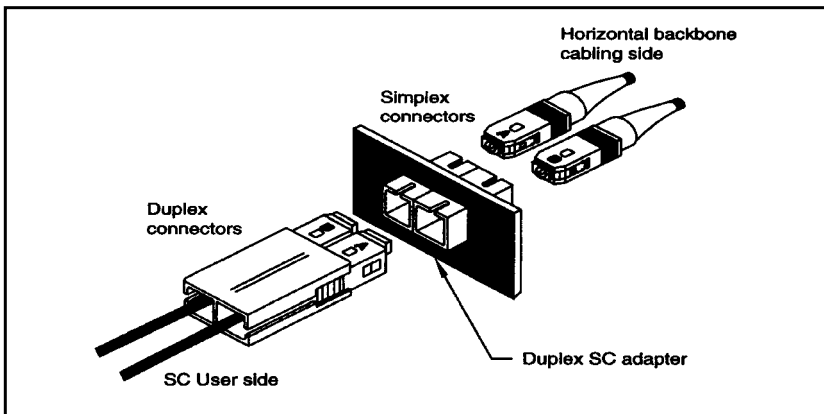

Duplex SC Patch Cord Crossover Orientation

FIGURE 7.11* Duplex SC Patch Cord Crossover Orientation

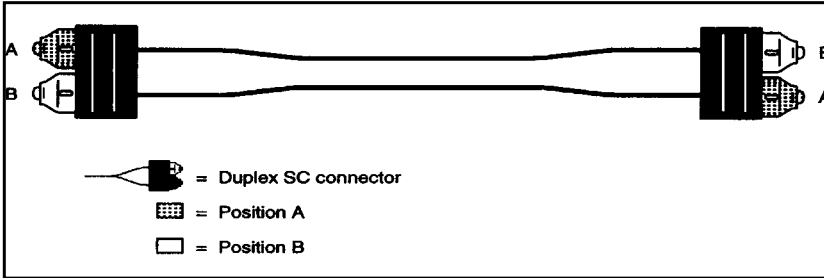

Optical Fibers

FIGURE 7.12 Optical Fibers

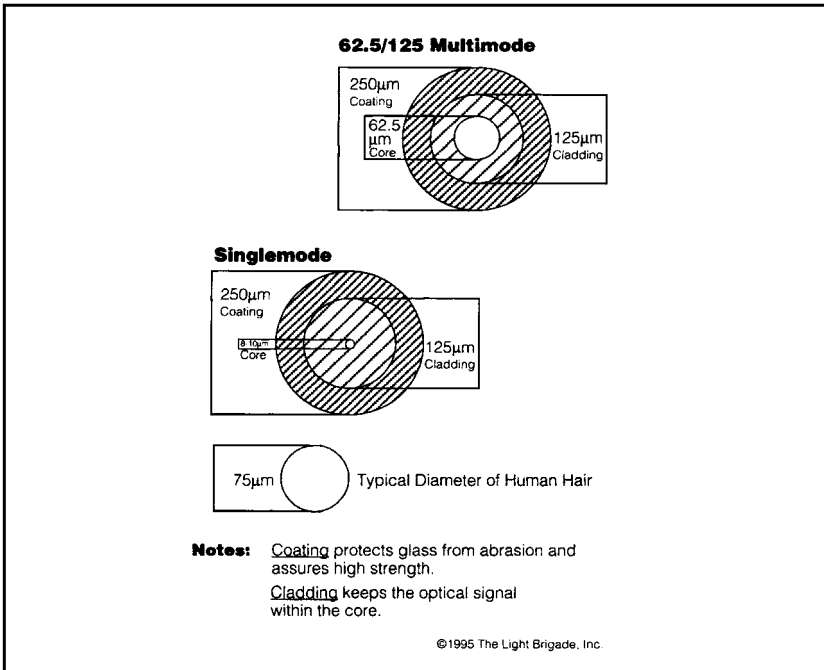

Backbone System Components

TABLE 7.21*

Component	Description
Cable pathways	Shafts, conduits, raceways, and floor penetrations (e.g., sleeves or slots) that provide routing space for cables.
ERs	Areas where telecommunications systems are housed and connected to the telecommunications wiring system (see Chapter 8: Equipment Rooms).
TRs	Areas or locations that contain telecommunications equipment for connecting the horizontal cabling to the backbone cabling systems (see Chapter 7: Telecommunications Rooms).
Telecommunications service entrance facility	An area or location where outside plant cables enter a building (see Chapter 9: Telecommunications Entrance Facilities and Termination).
Transmission media	<p>The actual cables, which may be:</p> <ul style="list-style-type: none"> • Optical fiber. • Twisted-pair copper. • Coaxial copper. <p>Connecting hardware, which may be:</p> <ul style="list-style-type: none"> • Connecting blocks. • Patch panels. • Interconnections. • Cross-connections. <p>NOTE: Backbone cabling can also be a combination of media.</p>
Miscellaneous support facilities	<p>Materials needed for the proper termination and installation of the backbone cables. These include:</p> <ul style="list-style-type: none"> • Cable support hardware. • Firestopping (see Chapter 15: Firestopping). • Grounding hardware (see Chapter 17: Grounding, Bonding, and Electrical Protection). • Protection and security.

Backbone Star Wiring Topology

FIGURE 7.13* Backbone Star Wiring Topology

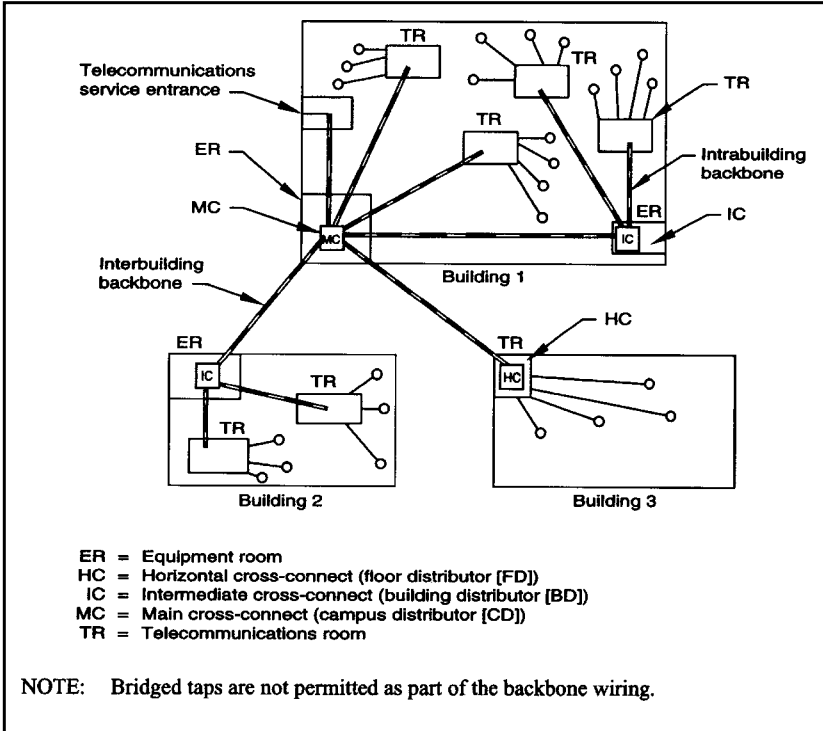

Example of Combined Copper/Fiber Backbone Supporting Voice and Data Traffic

FIGURE 7.14* Example of Combined Copper/Fiber Backbone Supporting Voice and Data Traffic

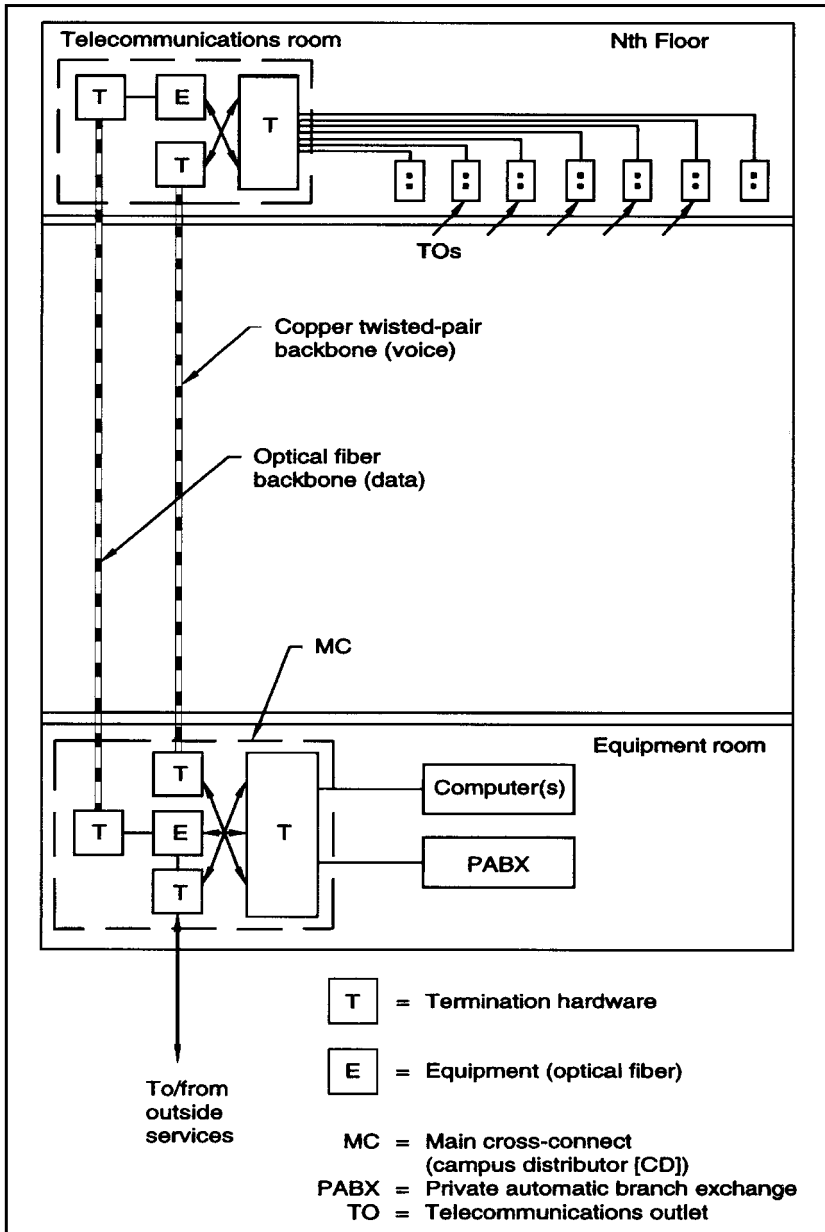

Backbone Distances

FIGURE 7.15* Backbone distances

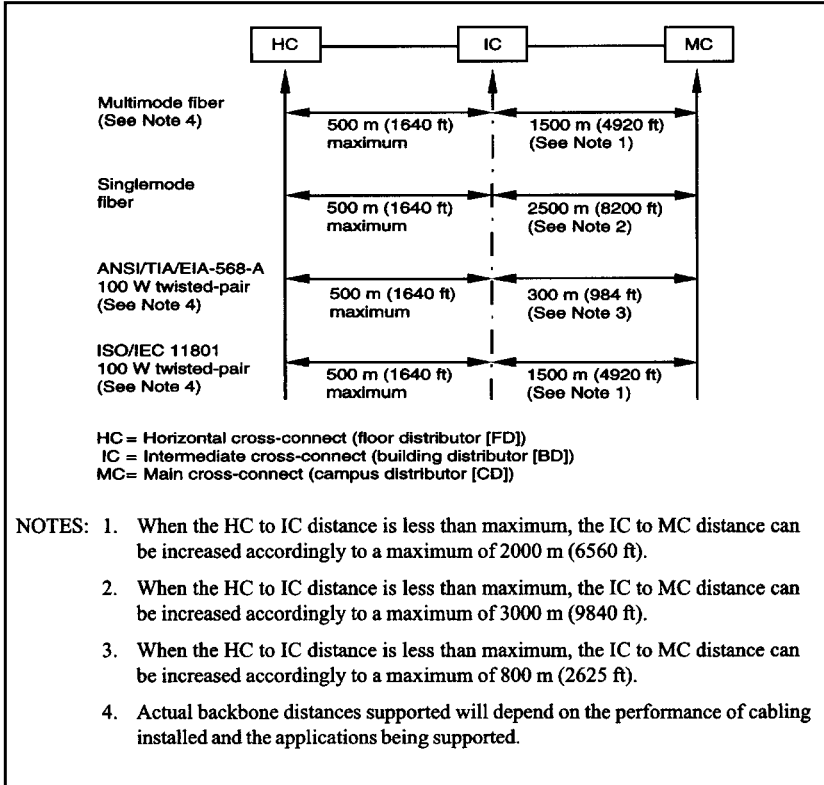

Determining 100 mm (4 in.) Floor Sleeves

TABLE 7.22*

Total Usable Floor Area Served in Sleeves m² (ft²)	Quantity of Sleeves
Up to 5000 (50,000)	3
> 5000 (50,000) to 10 000 (100,000)	4
> 10 000 (100,000) to 30 000 (300,000)	5-8
> 30 000 (300,000) to 50 000 (500,000)	9-12

Determining Size of Floor Slots

TABLE 7.23*

Total Usable Floor Area Served by Slot m² (ft²)	Size of Slot mm (in)
≤ 25 000 (250,000)	150 (6) x 225 (9)
> 25 000 (250,000) to 50 000 (500,000)	150 (6) x 450 (18)
> 50 000 (500,000) to 100 000 (1,000,000)	225 (9) x 500 (20)
> 100 000 (1,000,000) to 140 000 (1,400,000)	300 (12) x 500 (20)
> 140 000 (1,400,000) to 200 000 (2,000,000)	375 (15) x 600 (24)

WARNING: In general, all structural changes and floor penetrations must be approved by a licensed engineer of the same state in which the work is performed.

Conduit Fill Requirements for Backbone Cable

TABLE 7.24*

Conduit			Area of Conduit									Minimum Radius of Bends			
Trade Size mm (in)	Internal Diameter*		Area = .79D ² Total 100%		Maximum Occupancy Recommended						D		E		
					A		B		C						
							1 Cable 50% Fill		2 Cables 50% Fill		3 Cables or More 40% Fill		Layers of Steel within Sheath	Other Sheath	
mm	in	mm ²	in ²	mm ²	in ²	mm ²	in ²	mm ²	in ²	mm	in	mm	in		
21 (3/4)	20.9	0.82	345	0.53	183	0.28	107	0.16	138	0.21	210	8	130	5	
27 (1)	26.6	1.05	559	0.87	296	0.46	173	0.27	224	0.35	270	11	160	6	
35 (1-1/4)	35.1	1.38	973	1.51	516	0.80	302	0.47	389	0.60	350	14	210	8	
41 (1-1/2)	40.9	1.61	1322	2.05	701	1.09	410	0.64	529	0.82	410	16	250	10	
53 (2)	52.5	2.07	2177	3.39	1154	1.80	675	1.05	871	1.36	530	21	320	12	
63 (2-1/2)	62.7	2.47	3106	4.82	1646	2.56	963	1.49	1242	1.93	630	25	630	25	
78 (3)	77.9	3.07	4794	7.45	2541	3.95	1486	2.31	1918	2.98	780	31	780	31	
91 (3-1/2)	90.1	3.55	6413	9.96	3399	5.28	1988	3.09	2565	3.98	900	36	900	36	
103 (4)	102.3	4.03	8268	12.83	4382	6.80	2563	3.98	3307	5.13	1020	40	1020	40	
129 (5)	128.2	5.05	12 984	20.15	6882	10.68	4025	6.25	5194	8.06	1280	50	1280	50	
155 (6)	154.1	6.07	18 760	29.11	9943	15.43	5816	9.02	7504	11.64	1540	60	1540	60	

* Internal diameters are taken from the manufacturing standard for electrical metallic tubing (EMT) and rigid metal conduit.

Apply these fill percentages to straight runs with nominal offsets equivalent to no more than two 90-degree bends.

Column D indicates a bend of 10 times (10x) the conduit diameter for cable sheaths consisting partly of steel tape.

Column E indicates a bend of six times (6x) the conduit diameter up to 53 mm (2 trade size), and 10 times (10x) the conduit diameter above 53 mm (2 trade size).

NOTE: For additional information, see Conduit Guidelines in this section.

TR Cross-Connect Field Color Codes

TABLE 7.25*

The Color...	Identifies...
Orange	Demarcation point (e.g., central office terminations).
Green	Network connections (e.g., network and auxiliary equipment).
Purple	Common equipment, private branch exchange (PBX), local area networks (LANs), multiplexers (e.g., switching and data equipment).
White	First-level backbone (e.g., MC [CD] to a HC [FD] or to an IC [BD]).
Gray	Second-level backbone (e.g., IC [BD] to a HC [FD]).
Blue	Horizontal cable (e.g., horizontal connections to telecommunications outlets).
Brown	Interbuilding backbone (campus cable terminations). NOTE: Brown takes precedence over white or gray for interbuilding runs.
Yellow	Miscellaneous (e.g., auxiliary, alarms, security).
Red	Reserved for future use (also, key telephone systems).

NOTE: These color codes are aligned with ANSI/TIA/EIA-606.

TR Temperature Ranges

TABLE 7.26*

For Telecommunications Rooms That...	The Temperature Range Should Be...
Do not contain active equipment	10 °C to 35 °C (50 °F to 95 °F). It is preferable that temperature be maintained to within ± 5 °C (± 9 °F) of the adjoining office space and that humidity be kept below 85% relative humidity.
House active equipment	18 °C to 24 °C (64 °F to 75 °F). The humidity range should be 30% to 55% relative humidity.

TR Size Requirements

TABLE 7.27*

If the Serving Area Is...	Then the Interior Dimensions of the Room Must Be at Least...
500 m ² (5000 ft ²) or less	3.0 m x 2.4 m (10 ft x 8 ft). (See note below.)
Larger than 500 m ² and less than or equal to 800 m ² (>5000 ft ² to 8000 ft ²)	3.0 m x 2.7 m (10 ft x 9 ft).
Larger than 800 m ² and less than or equal to 1000 m ² (>8000 ft ² to 10,000 ft ²)	3.0 m x 3.4 m (10 ft x 11 ft).

NOTE: ANSI/TIA/EIA-569-A recommends a minimum TR size of 3.0 m x 2.1 m (10 ft x 7 ft). The size of 3 m x 2.4 m (10 ft x 8 ft) is specified here to allow a center rack configuration (see Figure 7.1).

Allocating Termination Space in TRs

TABLE 7.28*

For...	Allocate...
Twisted-pair cross-connections (see Notes)	2600 mm ² (4 in ²) for each 4-pair circuit to be patched or cross-connected (allows for two 4-pair cable terminations and two 4-pair modular patch connections per circuit).
Optical fiber cross-connections	1300 mm ² (2.0 in ²) for each fiber pair to be patched or cross-connected (allows for two cable/patch connections per channel). This space allocation is also appropriate for coaxial cable.

NOTES: For twisted-pair cross-connections using insulation displacement connector (IDC) connecting blocks and jumpers, cross-connect field density may be considerably greater.

When cabling requires surge protection, the recommended space allocation is two to four times larger than the space for regular cross-connections.

These space allocations do not include cable runs to and from the cross-connect fields. Up to 20 percent more space may be required for proper routing of cables, jumpers, and patch cords.

Typical Telecommunications Room (TR) Layout

FIGURE 7.16* Typical Telecommunications Room (TR) Layout

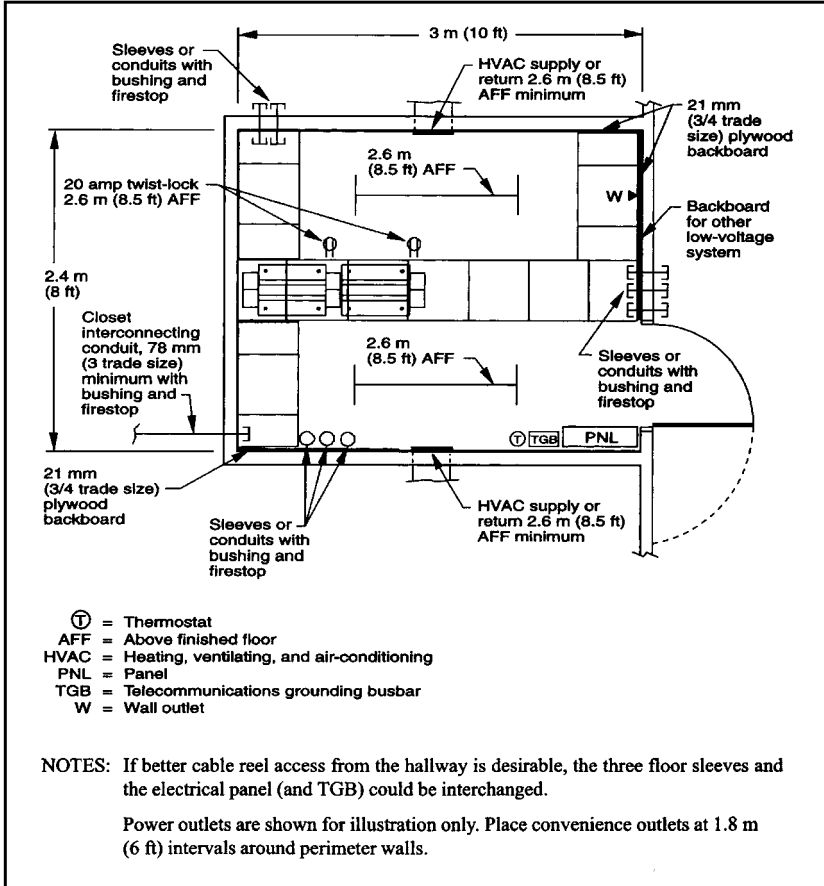

TR Industry Standards

TABLE 7.29*

Specification	Title
ANSI/TIA/EIA-568-A	<i>Commercial Building Telecommunications Cabling Standard.</i> (In Canada, see specification CSA T529-1996.)
ANSI/TIA/EIA-569-A	<i>Commercial Building Standard for Telecommunications Pathways and Spaces.</i> (In Canada, see specification CSA T530-1997.)
ANSI/TIA/EIA-570-A	<i>Residential Telecommunications Cabling Standard.</i>
ANSI/TIA/EIA-606	<i>Administration Standard for the Telecommunications Infrastructure of Commercial Buildings.</i> (In Canada, see specification CSA T528.)
ANSI/TIA/EIA-607	<i>Commercial Building Grounding and Bonding Requirements for Telecommunications.</i> (In Canada, see specification CSA T527.)
ISO/IEC 11801	<i>Generic Cabling for Customer Premises.</i>

The portions of the above-referenced specifications that relate directly to the content of this chapter include: Chapter 7 of ANSI/TIA/EIA-568-A; Chapter 7 of ANSI/TIA/EIA-569-A; Chapter 8 of ANSI/TIA/EIA-606; Chapter 7 of ANSI/TIA/EIA-607; and Chapter 5 of ISO/IEC 11801.

TR Regulatory and Safety Standards

TABLE 7.30*

Specification	Title
ANSI/NFPA 70	<i>The National Electrical Code®</i> , current edition.
CSA C22.1	<i>Canadian Electrical Code®, Part 1.</i>
FCC Part 68	<i>Code of Federal Regulations, Title 47, Telecommunications.</i>
UL 1459	<i>Underwriters Laboratories Standard for Safety—Telephone Equipment.</i>
UL 1863	<i>Underwriters Laboratories Standard for Safety—Communication Circuit Accessories.</i>

Environmental Control Systems Standards for Equipment Rooms (ERs)

TABLE 7.31*

Environmental Factor	Requirement
Temperature	18 °C to 24 °C (64 °F to 75 °F)
Relative humidity	30% to 55%
Heat dissipation	750 to 5,000 Btu per hour per cabinet

NOTES: Filtration systems may be required to minimize particle levels in the air.

Keep changes in temperature and humidity to a minimum.

HVAC sensors and controls must be located in the ER. Ideally, the sensors are placed 1.5 m (5 ft) above the finished floor.

Underground Entrance Conduits for Entrance Facilities (EFs)

TABLE 7.32*

Telephone Entrance Pairs...	Require...
1-99	One 53 mm (2 trade size) conduit plus 1 spare.
100-300	One 78 mm (3 trade size) conduit plus 1 spare.
301-1000	One 103 mm (4 trade size) conduit plus 1 spare.
1001-2000	Two 103 mm (4 trade size) conduits plus 1 spare.
2001-3000	Three 103 mm (4 trade size) conduits plus 1 spare.
3001-5000	Four 103 mm (4 trade size) conduits plus 1 spare.
5001-7000	Five 103 mm (4 trade size) conduits plus 1 spare.
7001-9000	Six 103 mm (4 trade size) conduits plus 1 spare.

Typical Underground Installation to EF

FIGURE 7.17* Typical Underground Installation to EF

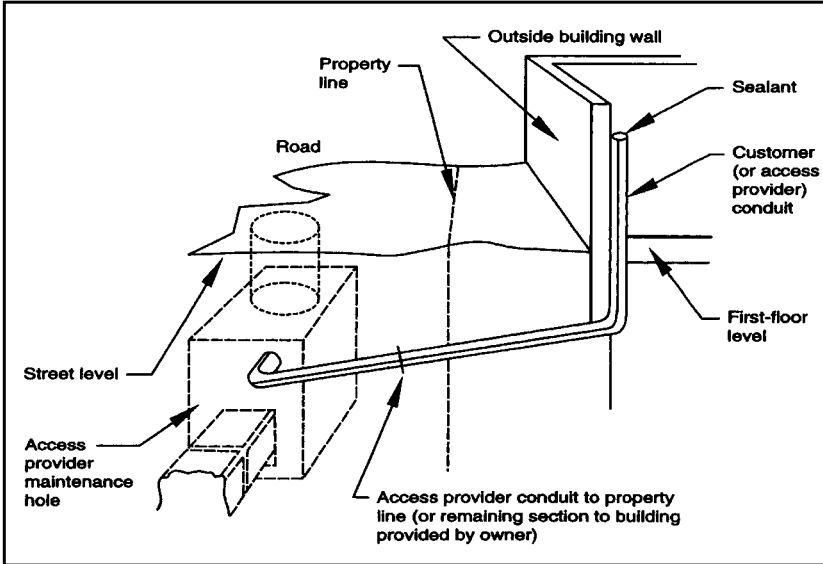

Equipment Room (ER) Floor Space (Special Use Buildings)

TABLE 7.33*

Work Areas	AREA	
	(m ²)	(ft ²)
Up to 100	14	150
101 to 400	37	400
401 to 800	74	800
801 to 1,200	111	1,200

Entrance Facility (EF) Wall Space (Minimum Equipment and Termination Wall Space)

TABLE 7.34*

GROSS FLOOR SPACE		WALL LENGTH	
m ²	ft ²	mm	in
500	5,000	990	39
1,000	10,000	990	39
2,000	20,000	1,060	42
4,000	40,000	1,725	68
5,000	50,000	2,295	90
6,000	60,000	2,400	96
8,000	80,000	3,015	120
10,000	100,000	3,630	144

Entrance Facility (EF) Floor Space (Minimum Equipment and Termination Floor Space)

TABLE 7.35*

GROSS FLOOR SPACE		ROOM DIMENSIONS	
m ²	ft ²	mm	ft
7,000	70,000	3,660 x 1,930	12 x 6.3
10,000	100,000	3,660 x 1,930	12 x 6.3
20,000	200,000	3,660 x 2,750	12 x 9
40,000	400,000	3,660 x 3,970	12 x 13
50,000	500,000	3,660 x 4,775	12 x 15
60,000	600,000	3,660 x 5,588	12 x 18.3
80,000	800,000	3,660 x 6,810	12 x 22.3
100,000	1,000,000	3,660 x 8,440	12 x 27.7

Separation of Telecommunications Pathways from 480-Volt or Less Power Lines

TABLE 7.36*

Condition	Minimum Separation Distance		
	< 2 kVA	2-5 kVA	> 5 kVA
Unshielded power lines or electrical equipment in proximity to open or nonmetal pathways.	127 mm (5 in)	305 mm (12 in)	610 mm (24 in)
Unshielded power lines or electrical equipment in proximity to a grounded metal conduit pathway	64 mm (2.5 in)	152 mm (6 in)	305 mm (12 in)
Power lines enclosed in a grounded metal conduit (or equivalent shielding) in proximity to a grounded metal conduit pathway.	- -	76 mm (3 in)	152 mm (6 in)

Cabling Standards Document Summary

TABLE 7.37*

Cabling Standards Document Summary

Several standards documents specify and/or recommend transmission parameters for the different cabling systems. Following is a summary of the most common documents:

ANSI/TIA/EIA-568-A, *Commercial Building Telecommunications Cabling Standard*

- Released October 1995.
- Covers Categories 3, 4, 5, and STP-A.
- Specifies:
 - Attenuation for cable and connecting hardware.
 - NEXT loss for cable and connecting hardware.

ANSI/TIA/EIA-568A-1, *Propagation Delay and Delay Skew Specifications for 100-Ohm 4-Pair Cable*

- Released September 1997.
- Covers Categories 3, 4, 5, and screened twisted-pair (ScTP).
- Specifies:
 - Propagation delay for cable.
 - Delay skew for cable.

ANSI/TIA/EIA-568A-3, *Hybrid Cables*

- Released September 1998.
- Covers hybrid and bundled cables.

ANSI/TIA/EIA-568-A-4, *Production Modular Cord NEXT Loss Test Method and Requirements for Unshielded Twisted-Pair Cabling*

- Released August 1999.
- Covers patch cords.

ANSI/TIA/EIA-568A-5, *Additional Transmission Performance Specifications for 4-Pair 100-Ohm Category 5e Cabling*

- Released in 1999.
- Covers Category 5e.
- Specifies:
 - NEXT loss for cable, connecting hardware, basic link, and channel.
 - PSNEXT loss for cable and cabling.
 - ELFEXT loss for cable and cabling.
 - FEXT loss for connecting hardware.
 - PSELFEXT loss for cable and cabling.
 - Return loss for cable, connecting hardware, basic link, and channel.
 - Propagation delay for basic link and channel.
 - Delay skew for basic link and channel.

7.3 BLOWN OPTICAL FIBER TECHNOLOGY (BOFT)

Overview

Reprinted with permission of General Cable Corporation (www.generalcable.com). BloLite is the trademark of BICC, PLC and is used under license.

Blown optical fiber technology is an exciting method of delivering a fiber solution that provides unmatched flexibility and significant cost savings when compared to conventional fiber cables. In a blown optical fiber system, the fiber route is “plumbed” with small tubes. These tubes, known as *microduct*, come in 5- and 8-mm diameters and are approved for riser, plenum, or outside-plant applications. They are currently available as a single microduct, or with two, four, or seven microducts bundled (straight, not twisted) and covered with an outer sheath, called *multiducts*. They are lightweight and easy to handle. Splicing along the route is accomplished through simple push-pull connectors. These microducts are empty during installation, thereby eliminating the possibility of damaging the fibers during installation.

Fiber is then installed, or “blown,” into the microduct. The fiber is fed into the microduct and rides on a current of compressed air. Carried by viscous drag, the fibers are lifted into the airstream and away from the wall of the microduct, thereby eliminating friction even around tight bends.

In a relatively short period, coated fibers can be blown for distances up to 1 km (3281 ft) in a single run of 8-mm-diameter microduct, up to 1000 ft vertical, or through any network architecture or topology turning up to 300 tight corners with 90° bends of 1-in. radius for over 1000 ft, using 5-mm-diameter microduct.

The practical benefits of BOFT systems translate directly into financial benefits for the end user. For most installations, the cost of a BOFT infrastructure is similar to or slightly higher than the cost for conventional fiber cabling. Savings can be realized during the initial installation because (1) it simplifies the cable installation by allowing the pulling of empty or unpopulated microduct; (2) fewer, if any, fiber splices may be required; and (3) you only pay up front for those fibers that you need immediately. The additional expense of hybrid cables is eliminated.

True cost savings and the convenience of blown optical fiber are realized during the first fiber upgrade or during moves, additions, and changes. An upgrade of an existing fiber backbone will generally incur workplace disruptions such as removing a ceiling grid, moving office furniture, and network downtime that requires the work to be done outside normal business hours. New fibers can be added to a BOFT system simply by accessing an existing unpopulated microduct and blowing in

the fibers. There is no disruption to the workplace, and the process requires a minimal amount of time to complete. In the event that there are no empty microducts, the existing fiber can be blown out in minutes and replaced with the new fiber type(s) immediately.

The flexibility of BOFT makes it particularly amenable to renovation and retrofit applications.

Diagram Showing Key Elements of BOFT System

FIGURE 7.18 Diagram Showing Key Elements of BOFT System

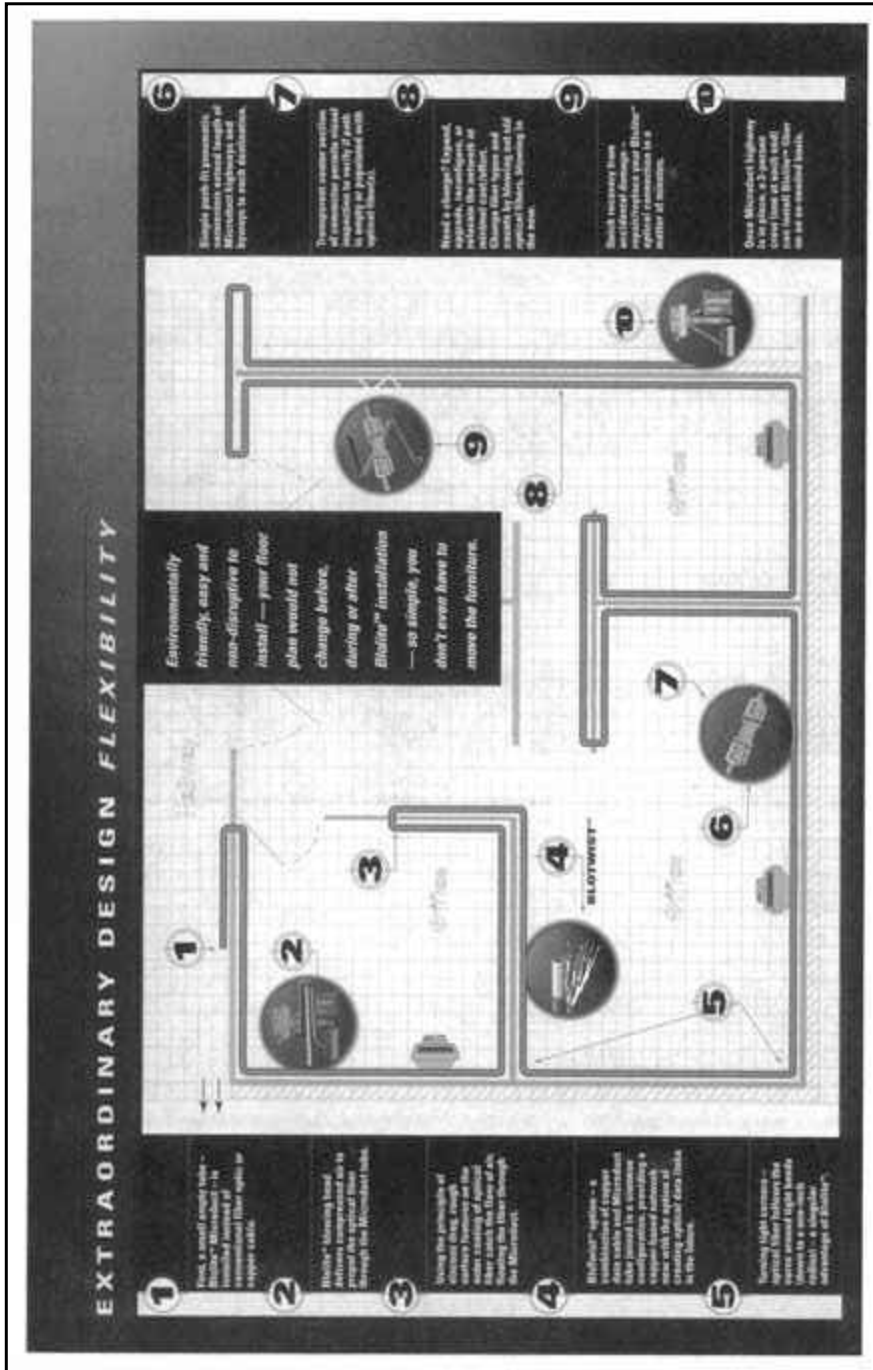





BLOFT Indoor Plenum 5-mm Multiduct

FIGURE 7.19 BLOFT Indoor Plenum 5-mm Multiduct

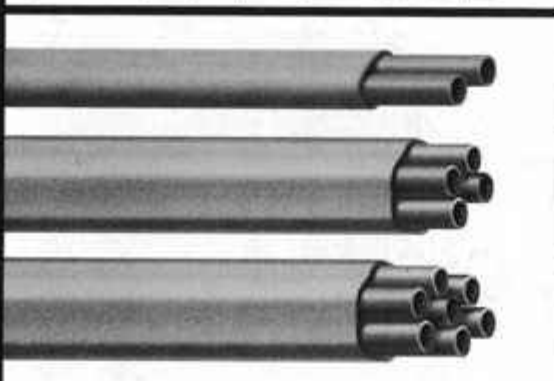
BLOLITE™ INDOOR PLENUM 5mm MULTIDUCT

Plenum-rated Multiduct consist of a number of 5mm OD/3.5mm ID Microducts (see 5mm Plenum Microduct data sheet). The Microduct tubing is covered by an outer jacket. The number of Microduct constructions available are 2, 4 or 7. All plenum Microducts are orange in color and are printed with a unique number at regular intervals. The overall jacket is a plenum-rated PVC material colored orange. The outer jacket surface has product identification printing and sequential length marking at one-meter intervals.

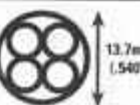

INSTALLATION TENSION	2 way 4 way 7 way	300N (67 lbs) 500N (112 lbs) 700N (157 lbs)	TEMPERATURE RANGE	Storage Installation Operating	-30°C to +85°C 0°C to +30°C -20°C to +70°C
MINIMUM BEND RADIUS (UNLOADED)	2 way 4 way 7 way	60mm 140mm 180mm	MAX. CRUSH RESISTANCE	2 Way 4 Way 7 way	1200N/cm (605 lbs/in) 1200N/cm (605 lbs/in) 1200N/cm (605 lbs/in)
MAX. INTERNAL PRESSURE	140 PSI				
COMPLIANCE	ETL TYPE OFNP c/ETL TYPE OFNP		NOMINAL WEIGHT		kg/m lbs/1000'
	2 way 4 way 7 way	56.2 120.2 185.3			23.1 80.8 124.5

ORDERING INFORMATION

PART NUMBER	DESCRIPTION	NOTES
706500	2 way 5mm Multiduct, plenum	1. Standard lengths are 500 and 1000 feet, supplied on non-rotatable reels. Ends are sealed to prevent the penetration of moisture prior to shipping.
707270	4 way 5mm Multiduct, plenum	
706350	7 way 5mm Multiduct, plenum	

BOFT Outdoor 8-mm Multiduct

FIGURE 7.20 BOFT Outdoor 8-mm Multiduct

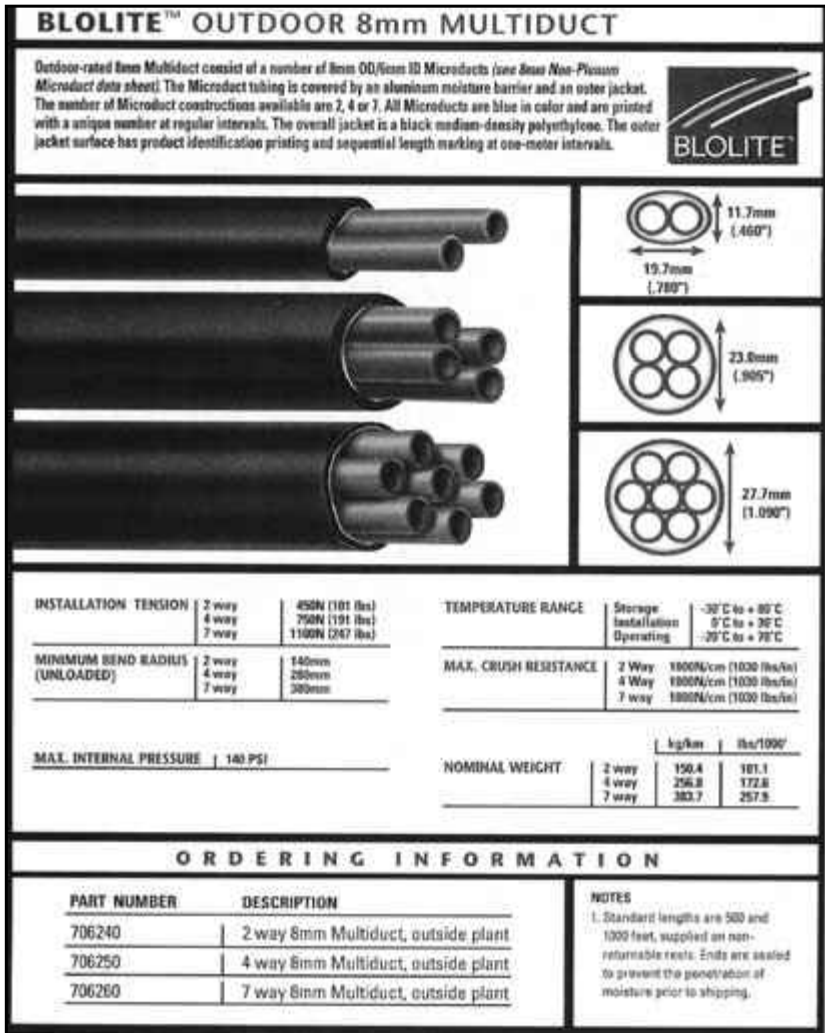

BOFT Installation Equipment

FIGURE 7.21 BOFT Installation Equipment

BLOLITE™ INSTALLATION EQUIPMENT

The efficient installation of optical fibers into Blolite Microduct requires the use of specially designed equipment. The Fiber Installation Equipment kit provides two units housed in sturdy carrying cases as well as a lightweight tripod.

An Air Supply Conditioning Unit (ACU)-complete with filtration and air-drying units, in addition to the component parts of the payout system, is housed in one case. The Installation Module—a blowing head—utilizing a mechanically driven system to introduce the fibers into the Microduct along with a fiber installation control device—is housed in another case.





FEED FROM COMPRESSOR OR AIR CYLINDER

TYPICAL INSTALLATION TIMES

In order to establish repeatable maximum blowing distances a series of tests have been conducted. All tests are based on four fibers being installed.

DUCT Size (mm)/Length (m)	ROUTE	INSTALLATION TIME Typical Spec.
5mm / 100m	standard	4 minutes
5mm / 300m	challenging	7 minutes
5mm / 500m	standard	40 minutes
8mm / 500m	standard	40 minutes
8mm / 1000m	standard	90 minutes

ORDERING INFORMATION

Blolite installation equipment is leased through a licensing agreement to certified installers. This lease includes permission to blow fiber under the original patent, the supply of the necessary equipment, training and certification, and technical support by BICCGeneral.

NOTES

A large grid area for taking notes, consisting of a 20x20 grid of small squares. The grid is empty and occupies the majority of the page below the 'NOTES' header.

CHAPTER EIGHT

Miscellaneous Special Applications

8.0 GENERAL

Introduction

It is the intent of this chapter to provide information and data that is often needed, but perhaps is a little bit outside of the mainstream day-to-day information required by the electrical design professional. In some cases, it represents emerging practices resulting from technological, code, or regulatory changes. In other cases, it represents popular *misapplication* of established codes or other requirements that are sometimes misunderstood. And finally, it may simply be information that is needed but less frequently encountered.

8.1 MINERAL-INSULATED CABLE APPLICATIONS

Mineral-insulated (MI) cable has been around for a long time and is a cable of the highest thermal capacity and integrity. Historically, because of these qualities, and the premium cost associated with these qualities, its applications have been limited. This has bred a lack of familiarity and reluctance to use this cable in many applications.

The National Electrical Code and many state and local code and regulatory requirements are changing this. Because this type of cable has a 2-h fire-resistive rating as approved by the Underwriters Laboratories (UL), this type of cable is gaining popularity in meeting the latest code mandates.

When reviewed at a microscopic level, as compared with conventional construction, using this type of cable for 1-h and 2-h fire-resistive construction, it becomes a cost-effective solution in complying with these code mandates. It also requires considerably less space (in the order of *97 percent less space*) in meeting these requirements, which makes it particularly amenable to renovation/retrofit projects.

Fire Pump and Other MI Cable Applications

Independent tests have shown 90°C wire in conduit fails to ground in less than 3 min when exposed to temperatures of less than 500°F. Because a fire in a typical commercial building generates temperatures in the range of 1200°F to 1500°F, conduit and wire provides unacceptable reliability during a fire.

High-rise buildings frequently have thousands of feet of emergency system wiring routed throughout a building. The potential for some portion of this system being exposed to high temperatures during a fire is high. Loss of critical feeder and branch circuits from a fire will disable equipment long before it has served its intended purpose, impeding evacuation and jeopardizing lives.

The National Electrical Code has addressed this in two sections. Section 700.9(C)(1) Fire Protection states: “Feeder-circuit wiring shall be installed either in spaces fully protected by approved automatic fire suppression systems or shall be a listed electrical circuit protective system with a minimum 1-hour fire rating.”

Article 695 of the NEC details the installation requirements of the electrical power sources and interconnecting circuits of centrifugal fire pumps. 695.6(B) circuit conductors states: “Fire pump supply conductors on the load side of the final disconnecting means and overcurrent device(s) permitted by 695.4(B) shall be kept entirely independent of all other wiring. They shall only supply loads that are directly associated with the fire pump system, and they shall be protected to resist potential damage by fire, structural failure, or operational accident. They shall be permitted to be routed through a building(s) using one of the following methods:

- (1) Be encased in a minimum 50 mm (2 in.) of concrete
- (2) Be within an enclosed construction dedicated to the fire pump circuit(s) and having a minimum of a 1-hour fire resistive rating
- (3) Be a listed electrical circuit protective system with a minimum 1-hour fire rating

Exception: The supply conductors located in the electrical equipment room where they originate and in the fire pump room shall not be required to have the minimum 1-hour fire separation or fire resistance rating, unless otherwise required by 700.9(D) of this Code.

With a 2-h fire-resistive rating approved by UL, MI-type cable provides a technological and cost-effective solution to this requirement. The Commonwealth of Massachusetts and other states now require a 2-h fire rating for emergency feeders.

The following data in Tables 8.1, 8.2, and 8.3 will assist in the application of MI cable.

TABLE 8.1 600-Volt MI Power Cable—Size and Ampacities

CURRENT RATING (75°C/90°C)* TERMINATION SIZE	-.24 1/2"	-.18 1/2"	-.18 1/2"	-.14.4 1/2"	-.12.6 3/4"
16 AWG					
CABLE REFERENCE	1850/215/1	1850/340/2	1850/355/3	1850/387/4	1850/449/7
CURRENT RATING (75°C/90°C)* TERMINATION SIZE	30/35 1/2"	20/25 1/2"	20/25 1/2"	16/20 3/4"	14/17.5 3/4"
14 AWG					
CABLE REFERENCE	1850/230/1	1850/371/2	1850/387/3	1850/418/4	1850/496/7
CURRENT RATING (75°C/90°C)* TERMINATION SIZE	35/40 1/2"	25/30 1/2"	25/30 1/2"	20/24 3/4"	17.5/21 3/4"
12 AWG					
CABLE REFERENCE	1850/246/1	1850/402/2	1850/434/3	1850/465/4	1850/543/7
CURRENT RATING (75°C/90°C)* TERMINATION SIZE	50/55 1/2"	35/40 3/4"	35/40 3/4"	28/32 3/4"	24.5/28 1"
10 AWG					
CABLE REFERENCE	1850/277/1	1850/449/2	1850/480/3	1850/527/4	1850/621/7
CURRENT RATING (75°C/90°C)* TERMINATION SIZE	70/80 1/2"	50/55 3/4"	50/55 3/4"	40/44 3/4"	
8 AWG					
CABLE REFERENCE	1850/309/1	1850/512/2	1850/543/3	1850/590/4	
CURRENT RATING (75°C/90°C)* TERMINATION SIZE	95/105 1/2"	65/75 3/4"	65/75 3/4"	52/60 1"	
6 AWG					
CABLE REFERENCE	1850/340/1	1850/590/2	1850/621/3	1850/684/4	
CURRENT RATING (75°C/90°C)* TERMINATION SIZE	125/140 1/2"	85/95 1"	85/95 1"		
4 AWG					
CABLE REFERENCE	1850/402/1	1850/684/2	1850/730/3		
	3 AWG	2 AWG	1 AWG	1/0 AWG	2/0AWG
CURRENT RATING (75°C/90°C)* TERMINATION SIZE	145/165 1/2"	170/190 3/4"	195/220 3/4"	230/260 3/4"	265/300 3/4"
CABLE REFERENCE	1850/434/1	1850/465/1	1850/496/1	1850/543/1	1850/590/1
	3/0 AWG	4/0 AWG	250 kcmil	350 kcmil	500 kcmil
CURRENT RATING (75°C/90°C)* TERMINATION SIZE	310/350 3/4"	360/405 1"	405/455 1"	505/570 1 1/4"	620/700 1 1/4"
CABLE REFERENCE	1850/637/1	1850/699/1	1850/746/1	1850/834/1	1850/1000/1

* Based on ampacities in the National Electrical Code® (NEC).

TABLE 8.2 300-Volt MI Twisted-Pair and Shielded Twisted-Pair Cable Sizes

	Twisted Pair	Shielded Twisted Pair
TERMINATION SIZE	1/2"	3/4"
18 AWG		
CABLE REFERENCE	1850/215/2T	1850/324/198/2T
TERMINATION SIZE	1/2"	3/4"
16 AWG		
CABLE REFERENCE	1850/246/2T	1850/364/230/2T

FIGURE 8.1 MI cable versus conventional construction in hazardous (classified) locations.

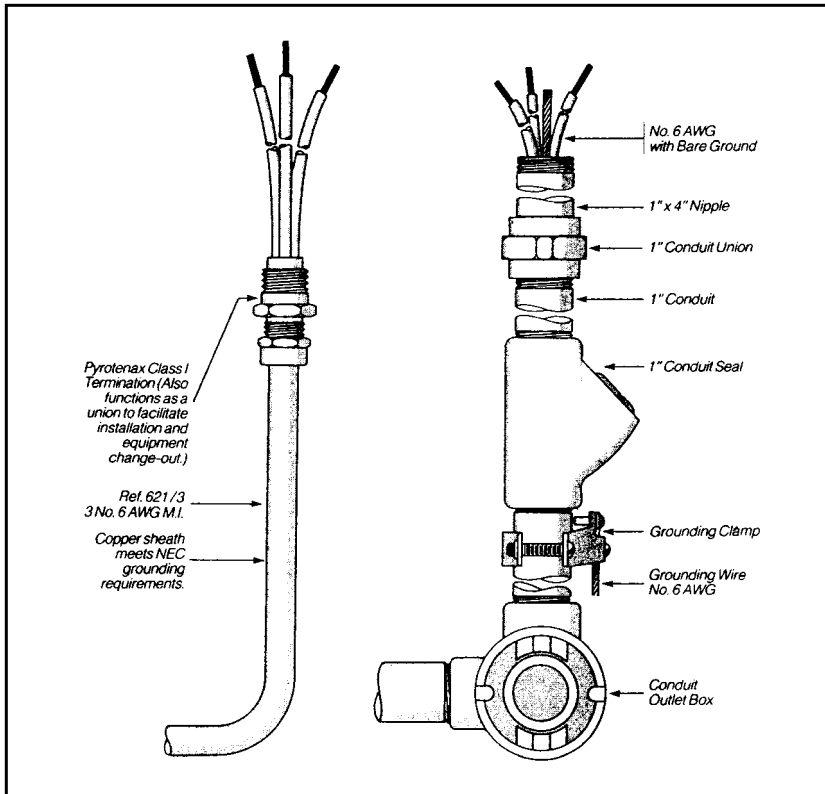

TABLE 8.3 Engineering Data—Calculating Voltage Drop and Feeder Sizing

Step I Determine Feeder Size

Estimate feeder size using the Voltage Drop Chart at right as in the following example:

- Run Length = 100'
- Circuit Voltage = 208 volts
- Circuit Amps = 400 amps
- Required Voltage Drop = 2% or 4.16 volts

Step II Verify Feeder Size

Using the formula and tables below, verify choice from Step I.

1. Voltage Drop = $\frac{(\text{Run Length}) \times (\text{Circuit Current}) \times (\text{Temperature Constant}) \times (\text{Factor from Voltage Drop Calculations Chart}) \times .87^*}{1000}$

* .87 is multiplier for 3-phase. Omit if making single phase calculation.

2. Using the values of the example:

$$\frac{100' \times 400 \times 1.0 \times .1112 \times .87}{1000} = 3.87 \text{ Volts Voltage Drop}$$

3. Percentage Voltage Drop = $\frac{\text{Voltage Drop}}{\text{Circuit Voltage}} \times 100\%$

4. Values from example:

$$\frac{3.87}{208} \times 100\% = 1.86\% \text{ Percent Voltage Drop}$$

5. Conclusion: Since 1.86% is better than the 2% voltage drop required, the choice of 250 MCM Pyrotenax MI Cable (746/1) is confirmed.

Temperature Constant Chart

Cable at full rated current	1.00
Cable at 3/4 rated current	0.95
Cable at 1/2 rated current	0.91
Cable at 1/4 rated current	0.88

Factors For Calculating Voltage Drop Using Pyrotenax MI Cable

AWG	Single Conductor	2 Conductor	3 Conductor	4 Conductor	7 Conductor
18		15.06	15.57	15.16	15.60
16	9.2	9.40	9.48	9.63	9.63
14	5.7	5.46	5.67	5.50	5.86
12	3.46	3.43	3.49	3.49	3.62
10	2.24	2.20	2.24	2.20	2.32
8	1.492	1.470	1.512	1.480	
6	.954	.928	.968	.944	
4	.602	.580	.608		
3	.478				
2	.406				
1	.314				
1/0	.254				
2/0	.202				
3/0	.1626				
4/0	.1296				
250 MCM	.1112				
350 MCM	.096				
500 MCM	.064				

Shaded area figures include an allowance for the effect of sheath loss (assuming the cables are run close together).

Classified Wiring (Hazardous) Locations

With approved terminations installed, MI cable meets the requirements of the NEC for wiring in areas classified as hazardous. The cable can be run in Classes I, II, and III, Divisions 1 and 2. Figure 8.1 shows a comparison between MI cable and conventional conduit/wire with accessories required for areas classified as hazardous. It has economic and technical merit.

8.2 FIRE PUMP APPLICATIONS

The electrical requirements for electric-drive fire pumps are discussed in detail in Chapters 6 and 7 and Appendix A of NFPA 20. These requirements are supplemented by NFPA 70 (NEC), in particular, Articles 230, 430, 695, and 700. The following guideline items are design highlights (based on Connecticut's and Massachusetts' requirements). Please refer to any different or additional codes or requirements that may be applicable in your state; however, the following should generally be applicable.

1. All electric fire pumps shall be provided with emergency power in accordance with Article 700 of NFPA 70. State of Connecticut requirement (add to Chapter 7, C.L.S.).
2. State of Massachusetts (add to 780 CMR, item 924.3): electrical fire pumps in many occupancies require emergency power per NFPA 20, and NEC Articles 695 and 700.
3. State of Massachusetts (add to 527 CMR, NEC, Article 700): emergency system feeders, generation and distribution equipment, including fire pumps, shall have a 2-h fire separation from all other spaces and equipment.
4. The fire pump feeder conductors shall be physically routed outside the building or enclosed in 2 in of concrete (1-h equivalent fire resistance) except in the electrical switchgear or fire pump rooms. NFPA 20, 6-3.1.1.
5. All pump room wiring shall be in rigid, intermediate, or liquid-tight flexible metal conduit. NFPA 20, 6-3.1.2 (MI cable is added to this in the 1993 version).
6. Maximum permissible voltage drop at the fire pump input terminals is 15 percent. NFPA 20, 6-3.1.4.
7. Protective devices (fuses or circuit breakers) ahead of the fire pump shall not open at the sum of the locked rotor currents of the facility or the fire pump auxiliaries. NFPA 20, 6-3.4.
8. The pump room feeder minimum size shall be 125 percent of the sum of the fire pump(s), jockey pump, and pump auxiliary full-load currents. NFPA 20, 6-3.5.
9. Automatic load shed and sequencing of fire pumps is permitted. NFPA 20, 6-7.

10. Remote annunciation of the fire pump controller is permitted per NFPA 20, 7-4.6 and 7-4.7. Note: A good practice is to assume this will happen and make provisions for it (i.e., fire alarm connections or wiring to the appropriate location).
11. When necessary, an automatic transfer switch may be used. It may be a separate unit or integrated with the fire pump controller in a barred compartment. NFPA 20, 7-8.2.
12. A jockey pump is not required to be on emergency power.
13. Step-loading the fire pump onto an emergency generator can help control the generator size. A time-delay relay (0 to 60 s) to

FIGURE 8.2 Typical one-line diagram of fire pump system with separate ATS.

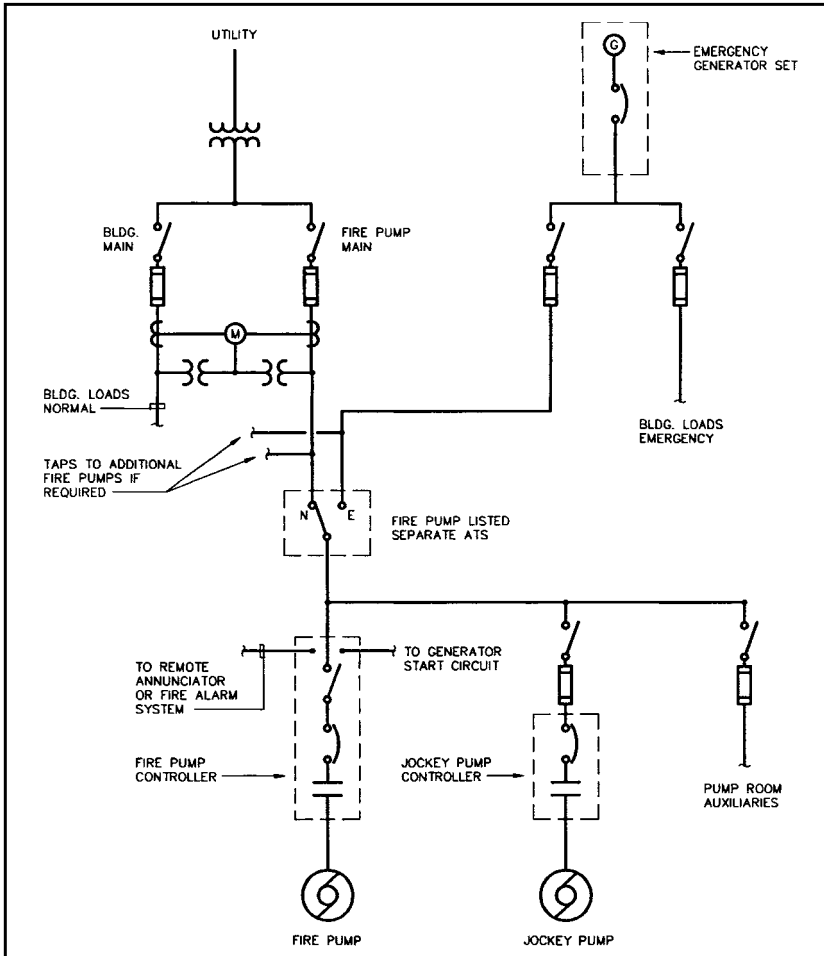

start or restart a fire pump when on generator power will help coordinate generator loading. The relay should be a part of the fire pump controller (see Item 9 above).

14. Reduced-voltage starters (i.e., autotransformer or wye-delta) for fire pumps are recommended.
15. Fire pumps, fire pump controllers, and fire pump-listed automatic transfer switches are generally provided under Division 15. Division 16 is responsible for powering, wiring, and connecting this equipment.

FIGURE 8.3 Typical one-line diagram of fire pump system with ATS integrated with the fire pump controller.

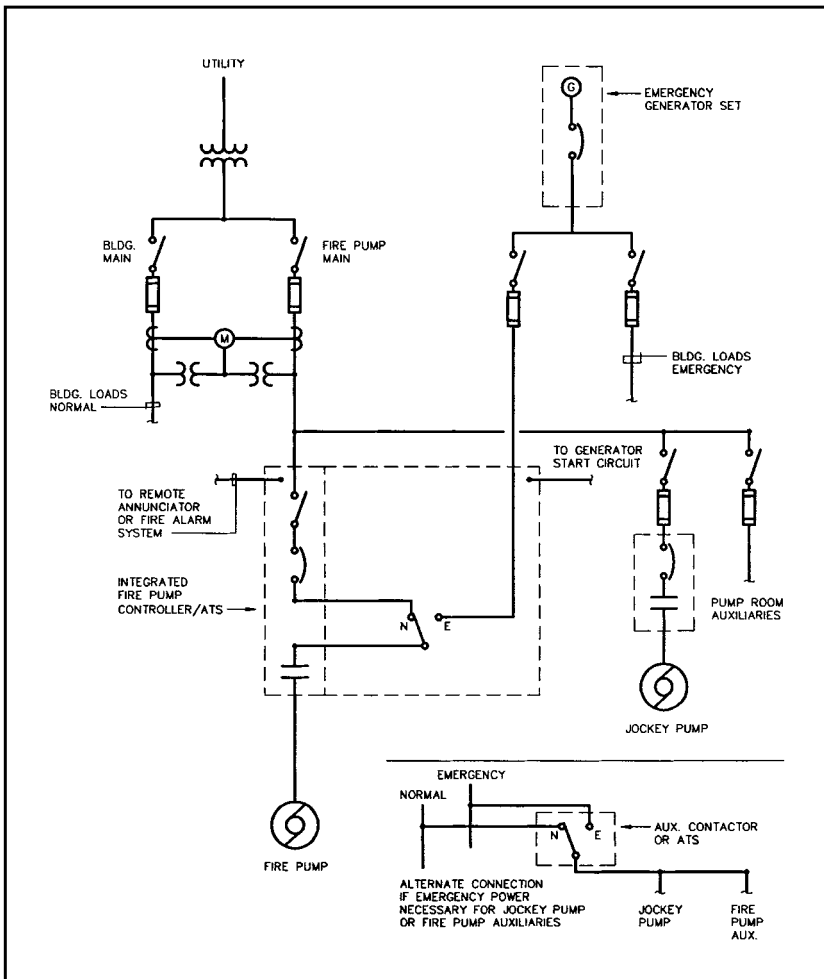

Figures 8.2 and 8.3 are typical one-line diagrams showing fire pump systems; Figure 8.2 is with a separate ATS, and Figure 8.3 is with an ATS integrated with the fire pump controller.

8.3 WIRING FOR PACKAGED ROOFTOP AHUS WITH REMOTE VFDS

An emerging trend in HVAC design is the use of packaged rooftop air-handling units (AHUs) with remote mounted variable-frequency drives (VFDs). In this circumstance, multiple electrical connections and significant additional wiring are required: not the traditional single point of connection previously needed. It is therefore critically important to coordinate closely with the mechanical design professionals to ensure that complete and proper wiring is provided.

Figure 8.4 shows an example of this situation with all of the additional wiring and connections required.

8.4 WYE-DELTA MOTOR STARTER WIRING

A common *mis*application that is encountered is the improper sizing of the six motor leads between the still very popular wye-delta reduced-voltage motor starter and the motor. This is best demonstrated by an example.

Assume that you have a 500-ton electrical centrifugal chiller operating at 460 V, three-phase, 60 Hz, with a nameplate rating of 588 full-load amps (FLA). You would normally apply the correct factor of 125 percent required by NEC Article 440, to arrive at the required conductor ampacity: $588 \times 1.25 = 735$ ampacity for each of the three conductors. Because there will be six conductors between the load side of the starter and the compressor motor terminals, the 735 ampacity is divided by two; you would select six conductors, each having an ampacity of not less than 368 A. Referring to NEC Article 310, Table 310-16 for insulated copper conductors at 75°C would result in the selection of 500-kcmil conductors.

This wire size is incorrect when used between the wye-delta starter and motor terminals. The problem is caused by a common failure to recognize that the motor may consist of a series of single-phase windings.

To permit the transition from wye-start to delta-run configuration, the motor is wound without internal connections. Each end of the three internal motor windings is brought out to a terminal, as shown in Figure 8.5.

The motor windings are configured as required for either starting or running at the starter as shown in Figure 8.6, panels *a* and *b*, respectively.

In the running-delta configuration, the field wiring from the load side of the starter to the compressor motor terminals consists of six conductors, electrically balancing the phases to each of the internal motor windings as described below in Figure 8.7.

FIGURE 8.4 Wiring of packaged rooftop AHUs with remote VFDs.

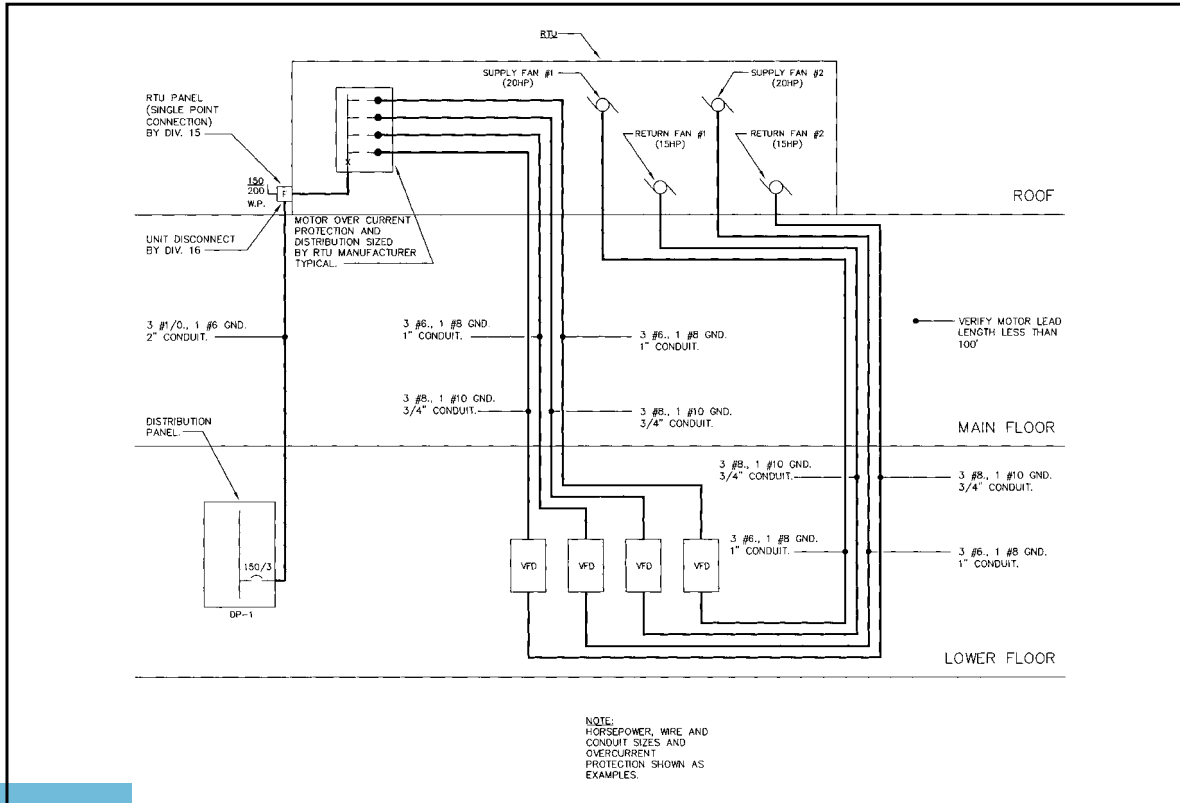

FIGURE 8.5 Wye-to-delta internal motor windings brought out to terminals.

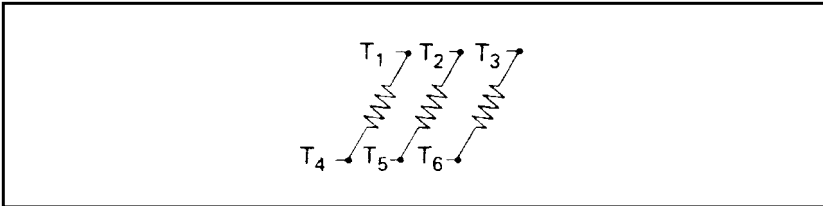

FIGURE 8.6 Wye-start, delta-run motor winding configuration.

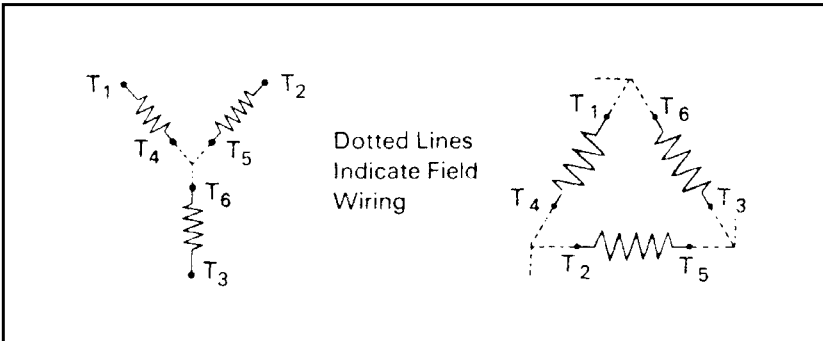
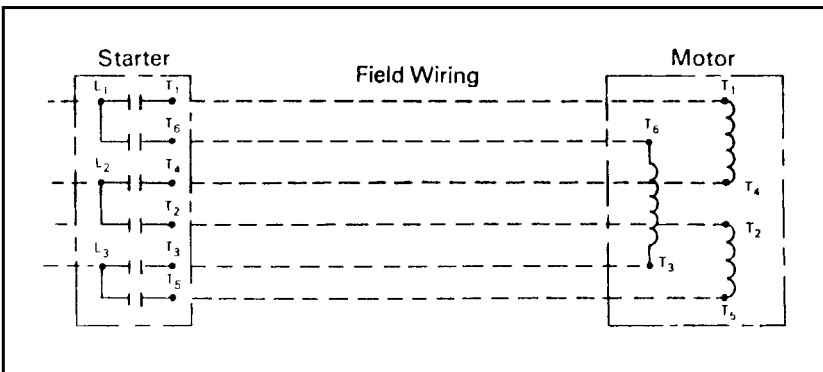

FIGURE 8.7 Field wiring between starter and motor in wye-start, delta-run configuration.



Note, for example, that motor winding $T_1 - T_4$ is connected to the line voltage across phase $L_1 - L_2$.

It should be apparent that the windings within the motor are single-phase-connected to the load side of the starter. Thus, the interconnecting field wiring between the starter and motor must be sized as though the motor were single-phase. Electrical terminology simply describes this motor as being phase-connected, and the current carried by the interconnecting conductors as phase amps.

To correctly size the conductors between the motor starter and the motor, therefore, it is necessary to calculate the ampacity with the 125 percent feeder-sizing factor required by the NEC on a single-phase basis as follows:

$$\text{Ampacity per terminal conductor} = \text{three-phase FLA} \times 1.25/1.73$$

For the example given:

$$\text{Ampacity per terminal conductor} = 588 \times 1.25/1.73 = 424$$

Thus, it is clear that the current in the conductors between the starter and the motor on a single-phase basis is 58 percent of the three-phase value, not 50 percent as originally assumed, because the current in one phase of a three-phase system in the delta-connected winding is one divided by the square root of three due to the vector relationship.

In the original example, the conductors were sized for a minimum ampacity of 368 A. From the NEC, 500-kcmil copper conductors at 75°C have a maximum allowable ampacity of 380. The preceding calculation discloses that the conductors should be selected for not less than 424 ampacity. Referring to the NEC again, 600-kcmil conductors have a maximum allowable ampacity of 420. In many cases, depending upon the interpretation of the local electrical inspector, 600 kcmil would be acceptable (usually within 3 percent is acceptable). Five-hundred-kilocircular mil wire would not be.

Almost needless to say, the conductors supplying the line side of the wye-delta starter are sized as conventional three-phase motor conductors.

8.5 MOTOR CONTROL DIAGRAMS

The following provides some basic motor control elementary and wiring diagrams of the most commonly encountered motor control requirements for convenient reference. The reader should refer to various motor control manufacturers for more extensive and detailed information that may be required for specific applications. The following diagrams (Figures 8.8 through 8.17) are courtesy of Square D Company.

FIGURE 8.8 Standard elementary diagram symbols. (Continued)

PUSH BUTTONS										PILOT LIGHTS																	
MOMENTARY CONTACT					MAINTAINED CONTACT ILLUMINATED					NON PUSH-TO-TEST		PUSH-TO-TEST															
SINGLE CIRCUIT		DOUBLE CIRCUIT		WOBBLE STICK	TWO SINGLE CKT.		ONE DOUBLE CKT.		NON PUSH-TO-TEST		PUSH-TO-TEST																
N.O.	N.C.	N.O. & N.C.	MUSHROOM HEAD																								
CONTACTS																											
INSTANT OPERATING				TIMED CONTACTS - CONTACT ACTION RETARDED AFTER COIL IS:																							
WITH BLOWOUT		WITHOUT BLOWOUT		ENERGIZED			N.O.T.C. N.C.T.O. N.C.T.C.			DE-ENERGIZED																	
N.O.	N.C.	N.O.	N.C.	N.O.T.C.	N.C.T.O.	N.C.T.C.	N.O.T.C.	N.C.T.O.	N.C.T.C.	N.O.T.C.	N.C.T.O.	N.C.T.C.															
TRANSFORMERS				AC MOTORS				DC MOTORS																			
AUTO		IRON CORE		AIR CORE		CURRENT		DUAL VOLTAGE		SINGLE PHASE		3 PHASE SQUIRREL CAGE		2 PHASE 4 WIRE		WOUND ROTOR		ARMATURE		SHUNT FIELD		SERIES FIELD		COMM OR COMPENS. FIELD			

FIGURE 8.8 Standard elementary diagram symbols. (Continued)

WIRING				CONNECTIONS		RESISTORS			CAPACITORS	
NOT CONNECTED	CONNECTED	POWER	CONTROL	WIRING TERMINAL	MECHANICAL	FIXED	ADJ BY FIXED TAPS	RHEOSTAT, POT OR ADJ. TAP	FIXED	ADJ.
				0	MECHANICAL INTERLOCK	RES H HEATING ELEMENT	RES	RH		
ANNUNCIATOR	BELL	BUZZER	HORN SIREN, ETC.	METER	METER SHUNT	HALF WAVE RECTIFIER	FULL WAVE RECTIFIER	BATTERY	FUSE	THERMO-COUPLE
				INDICATE TYPE BY LETTER						
IGNITRON TUBE										
SEMICONDUCTORS										
PROGRAMMABLE UNIT-CELL TRANSISTOR (PUT)										
SILICON CONTROLLED SCR										
SEMICONDUCTORS										
SEMICONDUCTORS										

FIGURE 8.9 Supplementary contact symbols.

SPST N.O.		SPST N.C.		SPDT		TERMS	SYMBOLS FOR STATIC SWITCHING CONTROL DEVICES
SINGLE BREAK	DOUBLE BREAK	SINGLE BREAK	DOUBLE BREAK	SINGLE BREAK	DOUBLE BREAK		
						SPST - SINGLE POLE SINGLE THROW	<p>STATIC SWITCHING CONTROL IS A METHOD OF SWITCHING ELECTRICAL CIRCUITS WITHOUT THE USE OF CONTACTS, PRIMARILY BY SOLID STATE DEVICES. USE THE SYMBOLS SHOWN IN TABLE ABOVE EXCEPT ENCLOSED IN A DIAMOND:</p> <p>EXAMPLES: INPUT "COIL" OUTPUT N.O. LIMIT SWITCH N.O. </p>
DPST, 2 N.O.		DPST, 2 N.C.		DPDT		SPDT - SINGLE POLE DOUBLE THROW	
						DPST - DOUBLE POLE SINGLE THROW	
						DPDT - DOUBLE POLE DOUBLE THROW	
SINGLE BREAK		DOUBLE BREAK		SINGLE BREAK		N.O. - NORMALLY OPEN	
SINGLE BREAK		DOUBLE BREAK		DOUBLE BREAK		N.C. - NORMALLY CLOSED	

FIGURE 8.10 Control and power connections—600 V or less, across-the-line starters (From NEMA Standard ICS 2-321A.60).

		1 PHASE	2 PHASE 4 WIRE	3 PHASE
LINE MARKINGS		L1, L2	L1, L3 - PHASE 1 L2, L4 - PHASE 2	L1, L2, L3
GROUND WHEN USED		L1 IS ALWAYS UNGROUNDED	—	L2
MOTOR RUNNING OVERCURRENT UNITS IN	1 ELEMENT	L1	—	—
	2 ELEMENT	—	L1, L4	—
CONTROL CIRCUIT CONNECTED TO		L1, L2	L1, L3	L1, L2
FOR REVERSING INTERCHANGE LINES		—	L1, L3	L1, L3

FIGURE 8.11 Terminology. (Continued)

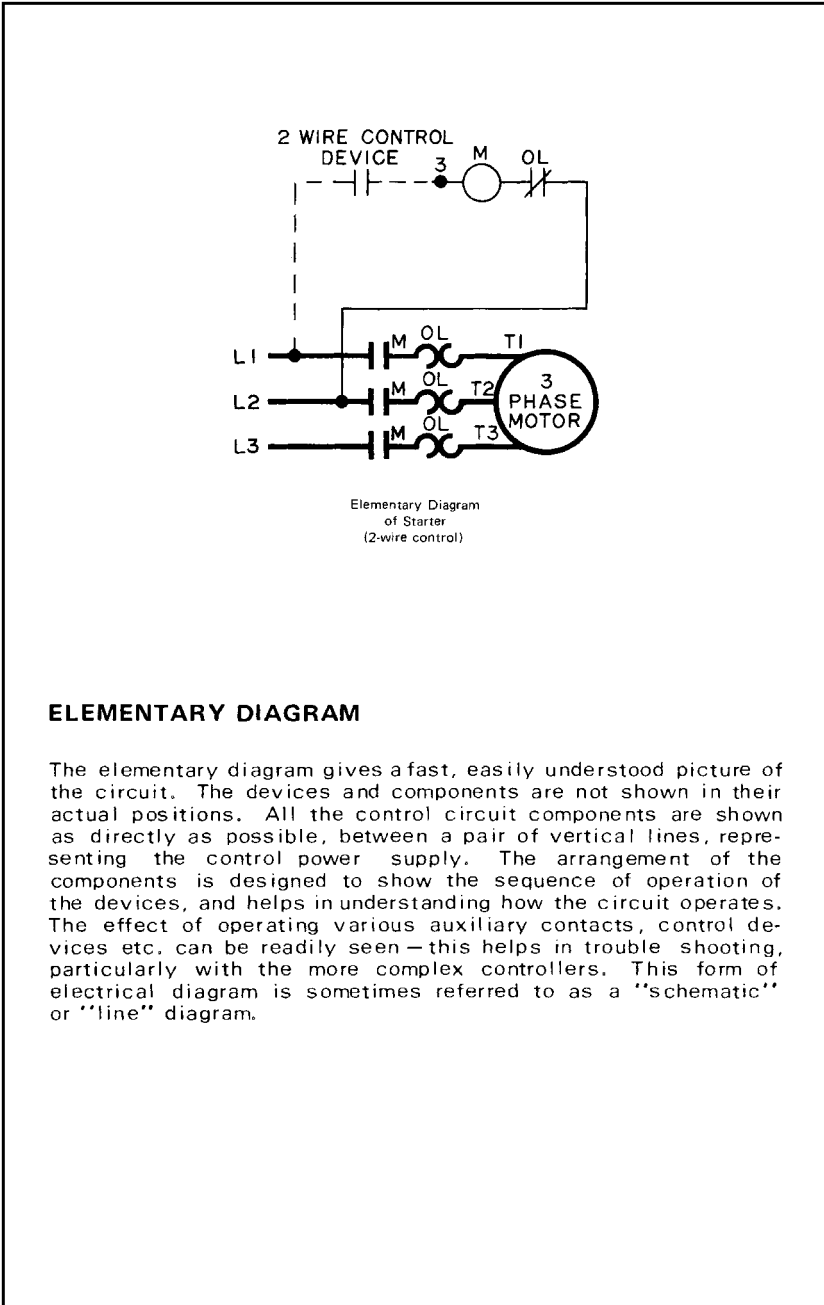

ELEMENTARY DIAGRAM

The elementary diagram gives a fast, easily understood picture of the circuit. The devices and components are not shown in their actual positions. All the control circuit components are shown as directly as possible, between a pair of vertical lines, representing the control power supply. The arrangement of the components is designed to show the sequence of operation of the devices, and helps in understanding how the circuit operates. The effect of operating various auxiliary contacts, control devices etc. can be readily seen — this helps in trouble shooting, particularly with the more complex controllers. This form of electrical diagram is sometimes referred to as a "schematic" or "line" diagram.

FIGURE 8.12 Examples of control circuits—elementary diagrams.

Low Voltage Release is a “two wire” control scheme using a maintained contact pilot device in series with the starter coil. This scheme is used when a starter is required to function automatically without the attention of an operator. If a power failure occurs while the contacts of the pilot device are closed, the starter will drop out. When the power is restored, the starter will pickup automatically through the closed contacts of the pilot device. The term “two wire” control arises from the fact that in the basic circuit, only two wires are required to connect the pilot device to the starter.

Low Voltage Protection is a “3 wire” control scheme using momentary contact push buttons or similar pilot devices to energize the starter coil. This scheme is used to prevent the unexpected starting of motors which could result in possible injury to machine operators or damage to driven machinery. The starter is energized by pressing the start button. An auxiliary “holding circuit” contact on the starter forms a parallel circuit around the start button contacts holding the starter in after the button is released. If a power failure occurs, the starter will drop out and will open the holding circuit contact. Upon resumption of power, the start button **must** be operated again before the motor will restart. The term “3 wire” control arises from the fact that in the basic circuit at least three wires are required to connect the pilot devices to the starter.

2 WIRE CONTROL

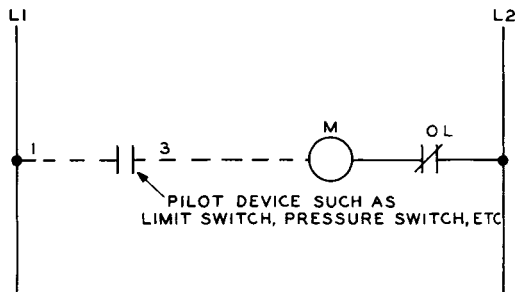

3 WIRE CONTROL

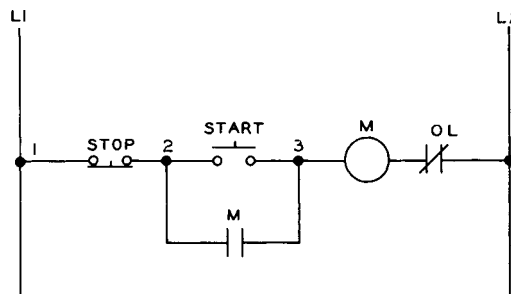
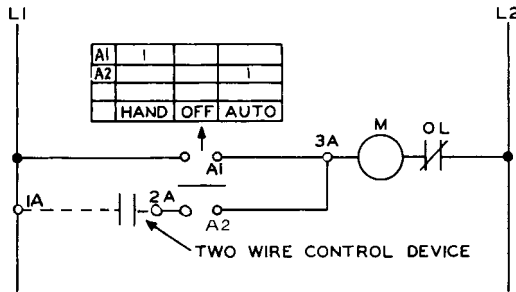

FIGURE 8.12 Examples of control circuits—elementary diagrams. (Continued)

2 WIRE CONTROL – WITH MAINTAINED CONTACT HAND-OFF-AUTO SELECTOR SWITCH



A "Hand-Off-Auto" selector switch is used on two wire control applications where it is desirable to operate the starter manually as well as automatically. The starter coil is energized manually when the switch is turned to the "Hand" position, and is energized automatically by the pilot device when the switch is in the "Auto" position.

3 WIRE CONTROL – MOMENTARY CONTACT MULTIPLE PUSH BUTTON STATION

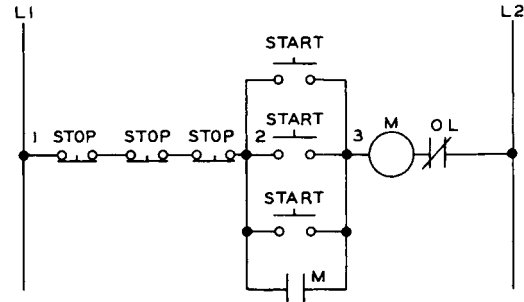

When a motor must be started and stopped from more than one location, any number of "Start" and "Stop" push buttons may be wired together as required. It is also possible to use only one "Start-Stop" station and have several "Stop" buttons at different locations to serve as emergency stop.

514

FIGURE 8.12 Examples of control circuits—elementary diagrams. (Continued)

515

3 WIRE CONTROL WITH PILOT LIGHT TO INDICATE WHEN MOTOR IS RUNNING

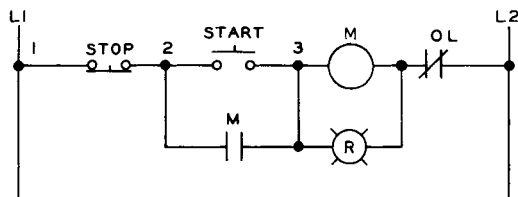

A pilot light can be wired in parallel with the starter coil to indicate when the starter is energized and thus show that the motor is running.

3 WIRE CONTROL WITH PILOT LIGHT TO INDICATE WHEN MOTOR IS STOPPED

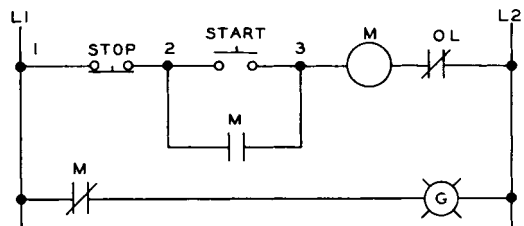

A pilot light may be required to indicate when the motor is stopped. This can be done by wiring a normally closed auxiliary contact on the starter in series with the pilot light as shown. When the starter is deenergized, the pilot light is on. When the starter picks up, the auxiliary contact opens, turning off the light.

FIGURE 8.12 Examples of control circuits—elementary diagrams. (Continued)

3 WIRE CONTROL WITH PUSH-TO-TEST PILOT LIGHT TO INDICATE WHEN MOTOR IS RUNNING

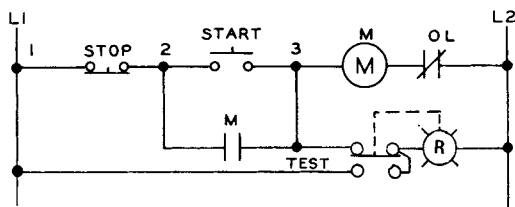

When the motor running pilot light is not lit, there may be doubt as to whether the circuit is open or whether the pilot light bulb is burned out. The push-to-test pilot light enables the testing of the bulb simply by pushing on the color cap.

3 WIRE CONTROL WITH ILLUMINATED PUSH BUTTON TO INDICATE WHEN MOTOR IS RUNNING

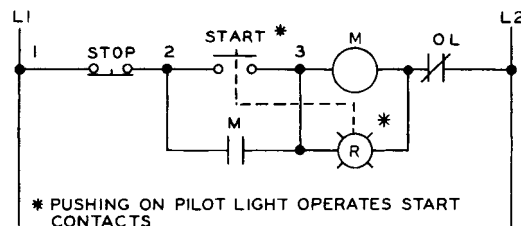

The illuminated push button combines a start button and a pilot light in one unit. Pressing the pilot light lens operates the start contacts. Space is saved by requiring only a two unit push button station instead of three.

FIGURE 8.12 Examples of control circuits—elementary diagrams. (Continued)

517

3 WIRE CONTROL WITH FUSED CONTROL CIRCUIT TRANSFORMER

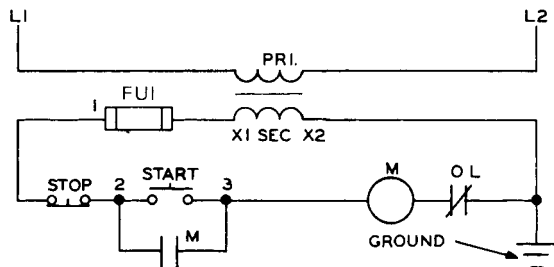

A step down transformer can be used to provide a control circuit voltage lower than line voltage for reasons of operator safety. This scheme shows one of the ways overcurrent protection can be provided for control circuits.

3 WIRE CONTROL WITH FUSED CONTROL CIRCUIT TRANSFORMER AND CONTROL RELAY

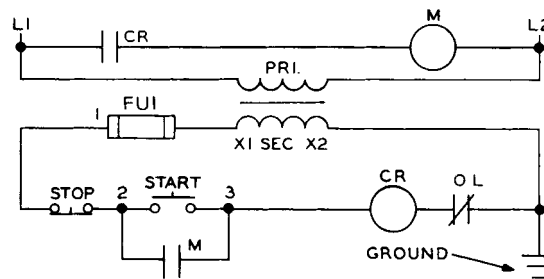

A starter coil with a high volt-ampere rating may require a control transformer of considerable size. A control relay and a transformer with a low VA rating can be connected so that the normally open relay contact controls the starter coil on the primary or line side. Square D Size 5 Form FT starters use this scheme.

FIGURE 8.12 Examples of control circuits—elementary diagrams. (Continued)

**JOGGING USING A SELECTOR SWITCH –
JOG WITH START BUTTON**

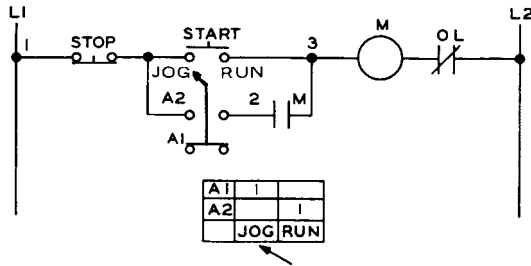

Jogging, or inching, is defined by NEMA as the momentary operation of a motor from rest for the purpose of accomplishing small movements of the driven machine. One method of jogging is shown above. The selector switch disconnects the holding circuit contact and jogging may be accomplished by pressing the "Start" button.

**JOGGING USING A SELECTOR
PUSH BUTTON**

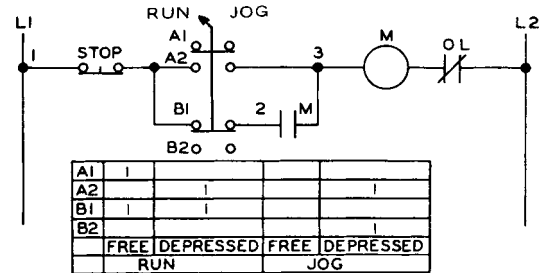

The use of a selector push button to obtain jogging is shown above. In the "Run" position the selector-push button gives normal 3 wire control. In the "Jog" position, the holding circuit is broken and jogging is accomplished by depressing the button.

FIGURE 8.12 Examples of control circuits—elementary diagrams. (Continued)

520

3 WIRE CONTROL - MORE THAN ONE STARTER, ONE PUSH BUTTON STATION CONTROLS ALL

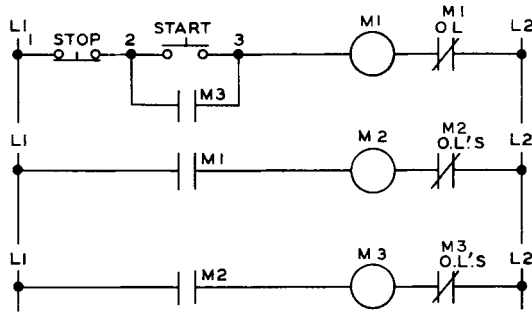

When one "Start-Stop" station is required to control more than one starter, the scheme above can be used. A maintained overload on any one of the motors will drop out all three starters.

3 WIRE CONTROL - REVERSING STARTER

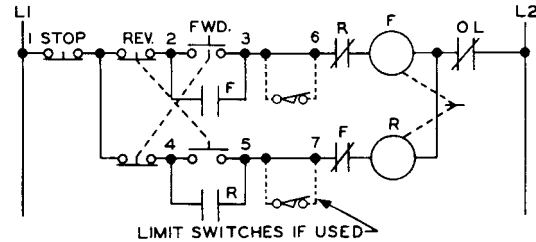

3 wire control of a reversing starter can be accomplished with a "Forward-Reverse-Stop" push button station as shown above. Limit switches can be added to stop the motor at a certain point in either direction. Jumpers 6 to 3 and 7 to 5 must then be removed.

FIGURE 8.12 Examples of control circuits—elementary diagrams. (Continued)

**3 WIRE CONTROL - REVERSING STARTER
MULTIPLE PUSH BUTTON STATION**

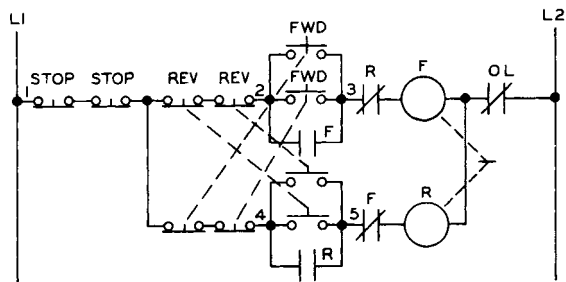

More than one "Forward-Reverse-Stop" push button station may be required and can be connected in the manner shown above.

**3 WIRE CONTROL - REVERSING STARTER
WITH PILOT LIGHTS TO INDICATE
DIRECTION MOTOR IS RUNNING**

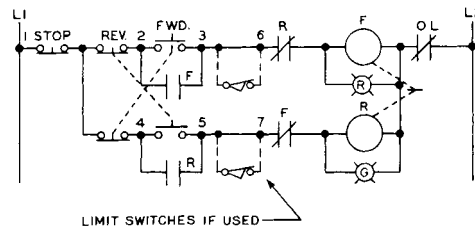

Pilot lights can be connected in parallel with the forward and reverse contactor coils to indicate which contactor is energized and thus which direction the motor is running.

FIGURE 8.12 Examples of control circuits—elementary diagrams. (Continued)

3 WIRE CONTROL - TWO SPEED STARTER

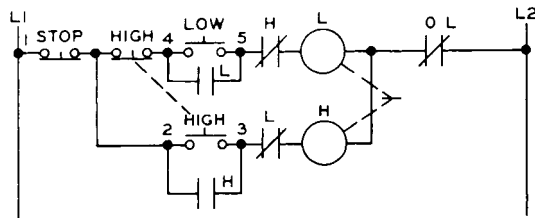

3 wire control of a two speed starter with a "High-Low-Stop" push button station is shown above. This scheme allows the operator to start the motor from rest at either speed or to change from low to high speed. The "Stop" button must be operated before it is possible to change from high to low speed. This arrangement is intended to prevent excessive line current and shock to motor and driven machinery which results when motors running at high speed are reconnected for a lower speed.

3 WIRE CONTROL - TWO SPEED STARTER WITH ONE PILOT LIGHT TO INDICATE MOTOR OPERATION AT EACH SPEED

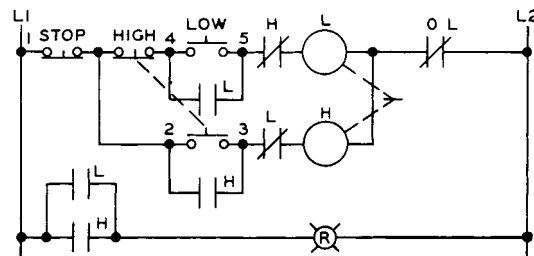

One pilot light can be used to indicate operation at both low and high speeds. One extra normally open auxiliary contact on each contactor is required. Two pilot lights, one for each speed, could be used by connecting pilot lights in parallel with high and low coils. (See Reversing Starter diagram above.)

FIGURE 8.12 Examples of control circuits—elementary diagrams. (Continued)

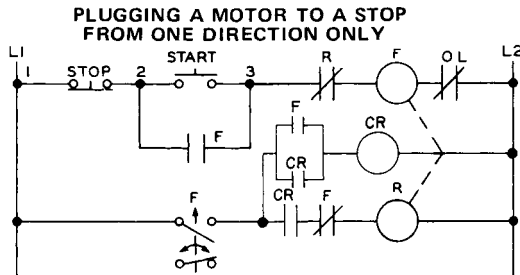

Plugging is defined by NEMA as a system of braking in which the motor connections are reversed so that the motor develops a counter torque, thus exerting a retarding force. In the above scheme the forward rotation of the motor closes the normally open plugging switch contact and energizing control relay CR. When the "Stop" button is operated the forward contactor drops out, the reverse contactor is energized through the plugging switch, the control relay contact as well as the normally closed forward auxiliary contact. This reverses the motor connections and the motor is braked to a stop. The plugging switch then opens and disconnects the reverse contactor, the control relay drops out as well. The control relay makes it impossible for the motor to be plugged in reverse by rotating the motor rotor closing the plugging switch. This type of control is used for plugging and not for running in reverse.

ANTI-PLUGGING - MOTOR TO BE REVERSED BUT MUST NOT BE PLUGGED

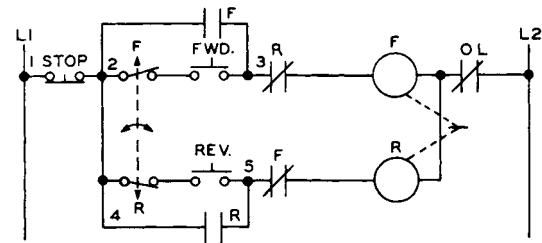

Anti-plugging protection is defined by NEMA as the effect of a device which operates to prevent application of counter-torque by the motor until the motor speed has been reduced to an acceptable value. In the scheme above, with the motor operating in one direction, a contact on the anti-plugging switch opens the control circuit of the contactor used for the opposite direction. This contact will not close until the motor has slowed down, after which the other contactor can be energized.

FIGURE 8.13 Examples of overcurrent protection for control circuits.

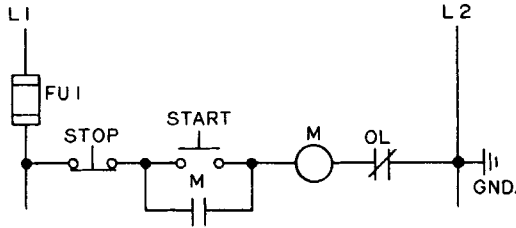

Common control with fusing in one line only and with both lines ungrounded or, if user's conditions permit, with one line grounded.

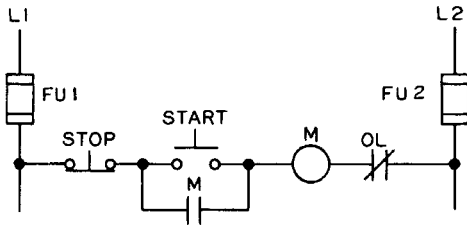

Common control with fusing in both lines and with both lines ungrounded.

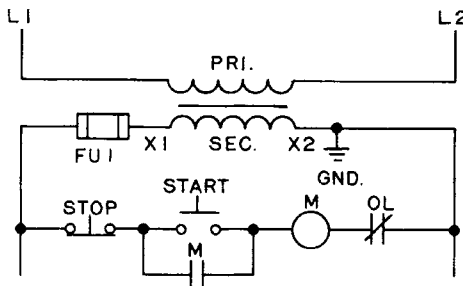

Control circuit transformer with fusing in one secondary line and with both secondary lines ungrounded or, if user's conditions permit, with one line grounded.

FIGURE 8.13 Examples of overcurrent protection for control circuits.
(Continued)

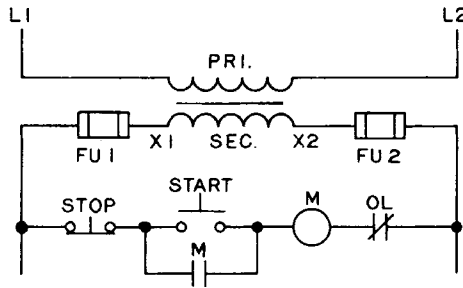

Control circuit transformer with fusing in both secondary lines and with both secondary lines ungrounded.

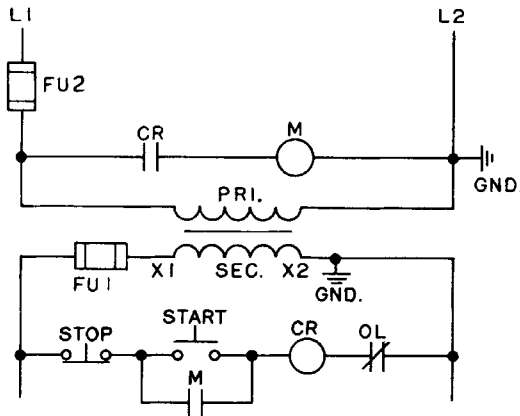

Control circuit transformer with fusing in one primary and one secondary line, and with all lines ungrounded, or, if user's conditions permit, with one primary and one secondary line grounded.

FIGURE 8.13 Examples of overcurrent protection for control circuits.
(Continued)

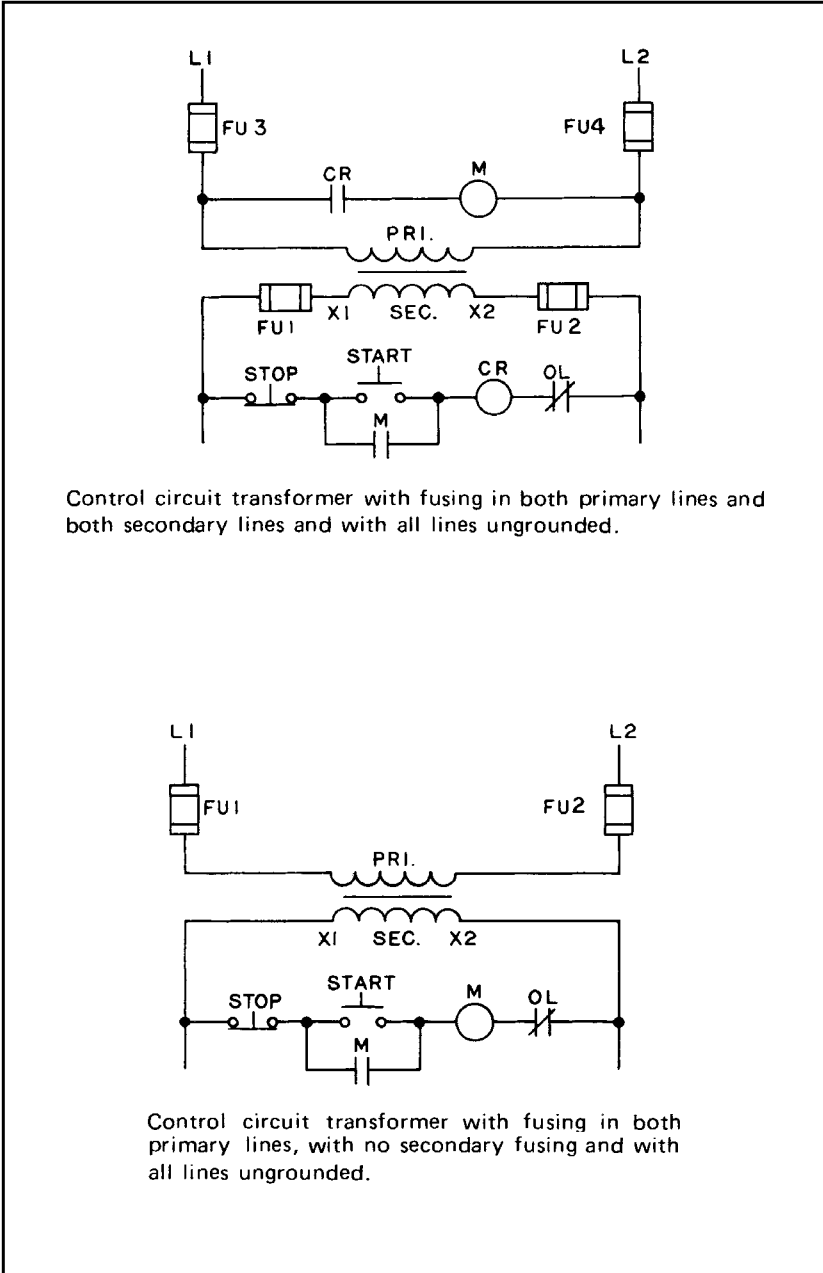

FIGURE 8.14 AC manual starters and manual motor starting switches.

MANUAL MOTOR STARTING SWITCHES—TYPE K

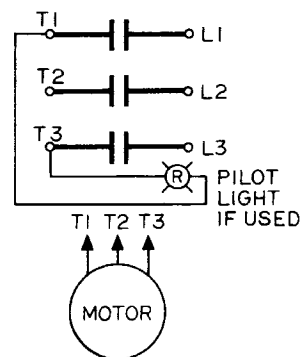
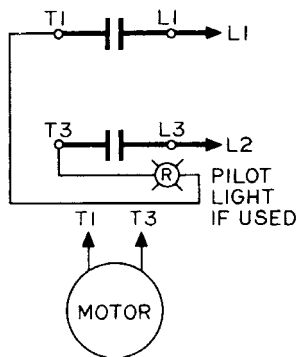

FIGURE 8.14 AC manual starters and manual motor starting switches. (*Continued*)

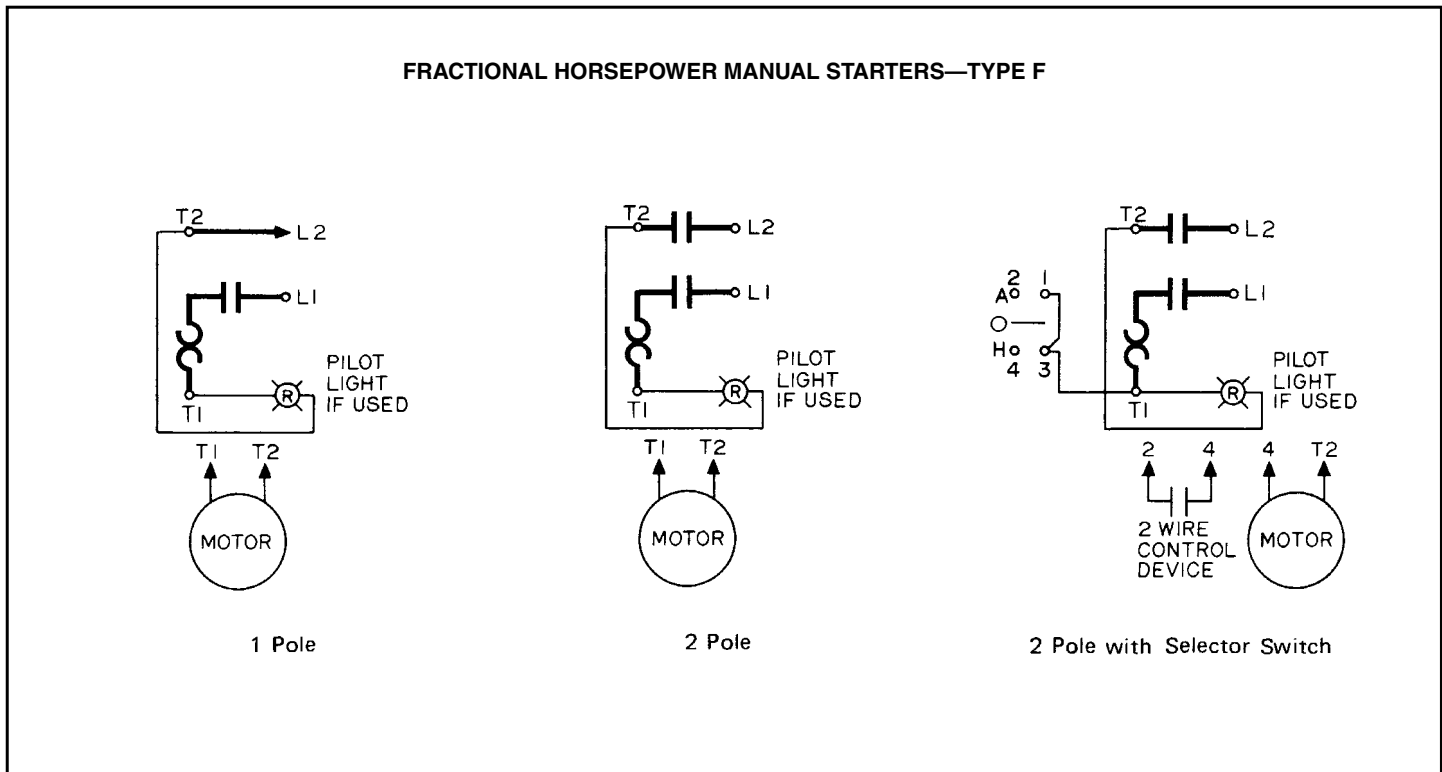
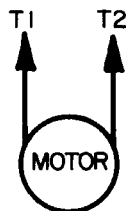
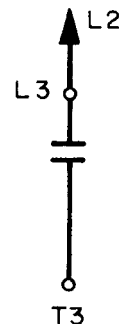
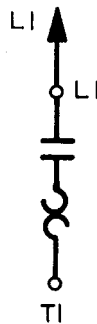
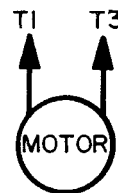

FIGURE 8.14 AC manual starters and manual motor starting switches. (*Continued*)

INTEGRAL HORSEPOWER MANUAL STARTERS—SIZES M-0 AND M-1



2 Pole, 1 Phase



3 Pole 1 Phase

FIGURE 8.14 AC manual starters and manual motor starting switches. (*Continued*)

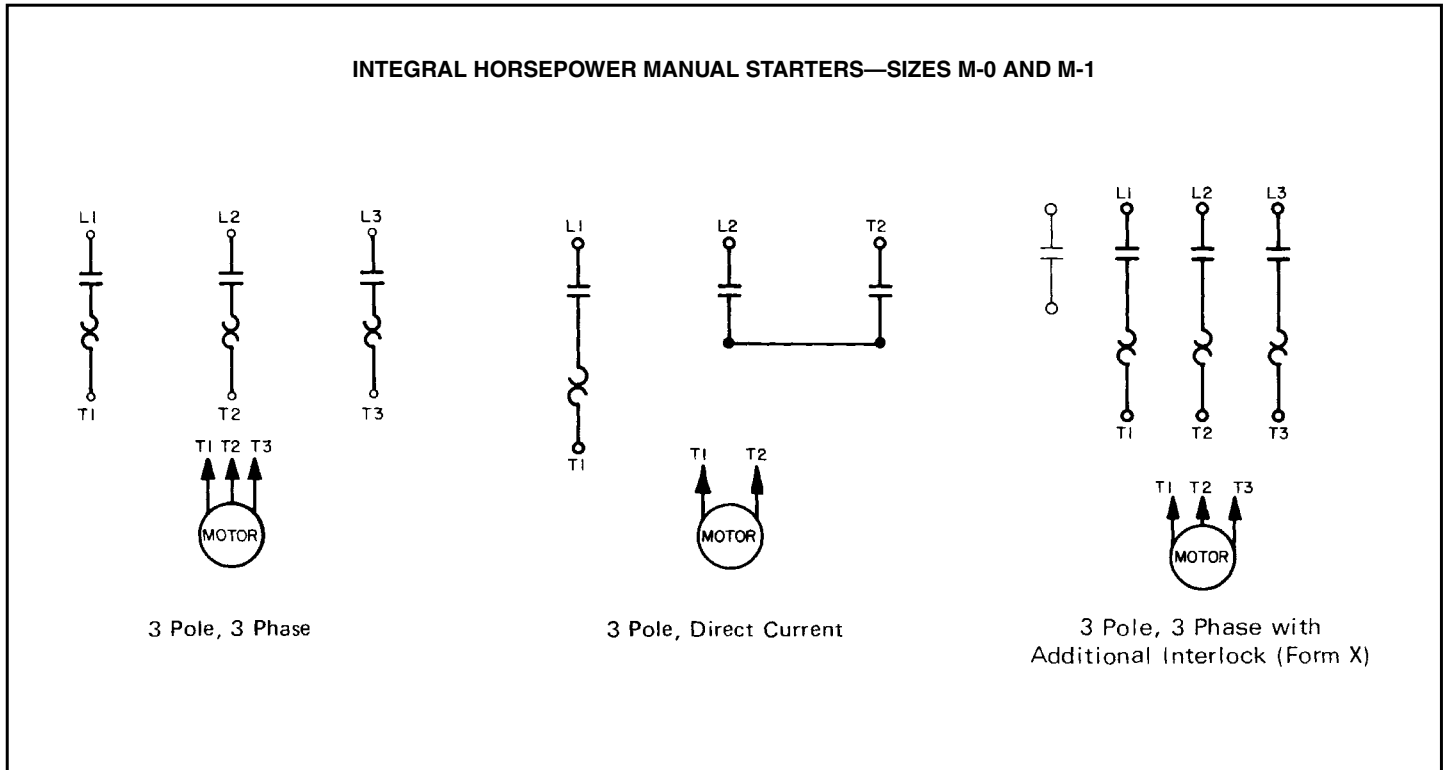
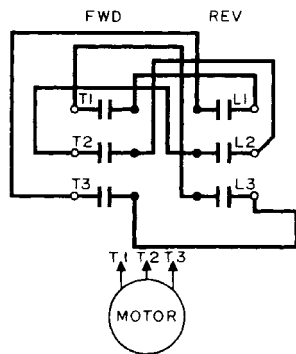

FIGURE 8.14 AC manual starters and manual motor starting switches. (Continued)

AC REVERSING MANUAL STARTERS AND MANUAL MOTOR STARTING SWITCHES

REVERSING MANUAL MOTOR STARTING SWITCH



Type K, 3 Pole, 3 Phase

REVERSING MANUAL STARTER

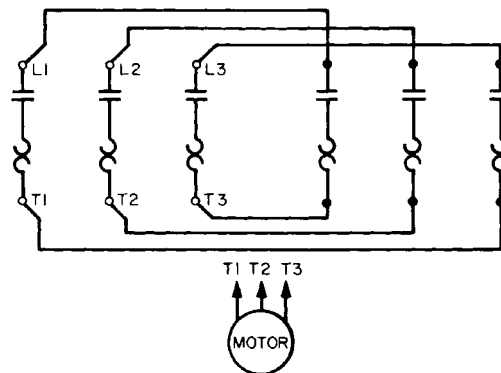

Sizes M-0 and M-1, 3 Pole, 3 Phase

FIGURE 8.14 AC manual starters and manual motor starting switches. (Continued)

AC TWO SPEED MANUAL STARTERS AND MANUAL MOTOR STARTING SWITCHES

TWO SPEED MANUAL MOTOR STARTING SWITCH - TYPE K

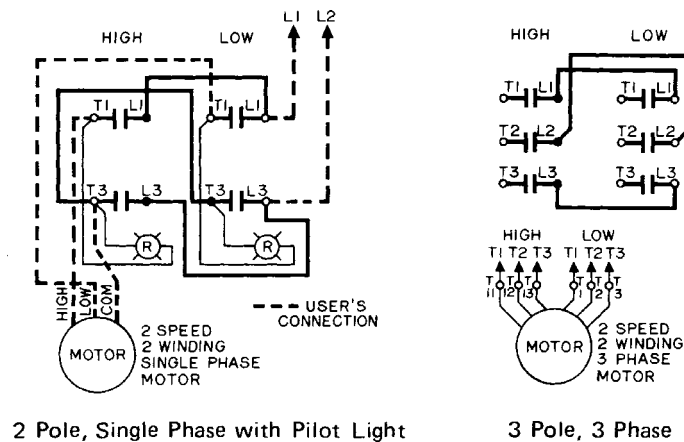
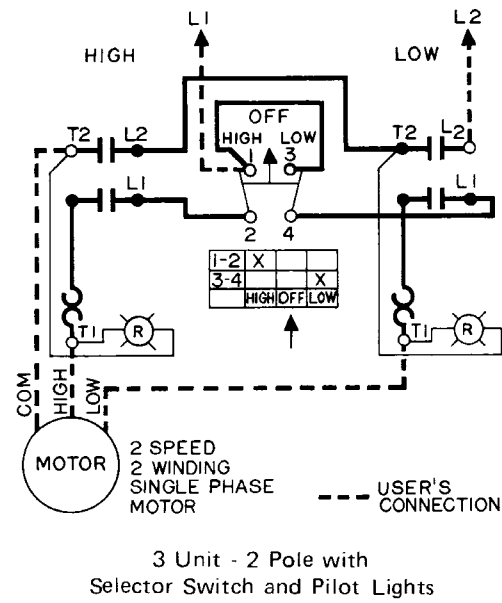
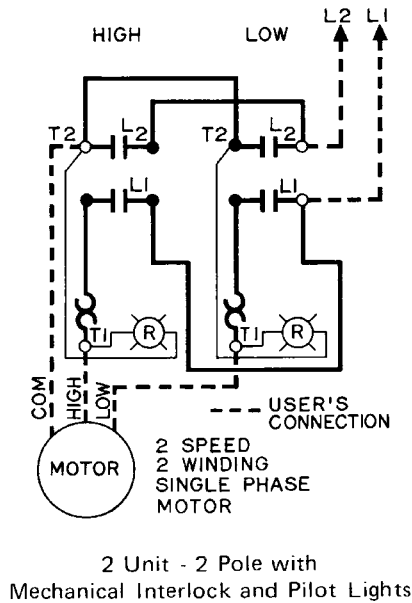

FIGURE 8.14 AC manual starters and manual motor starting switches. (Continued)

TWO SPEED MANUAL MOTOR STARTERS—TYPE F



533

FIGURE 8.14 AC manual starters and manual motor starting switches. (*Continued*)

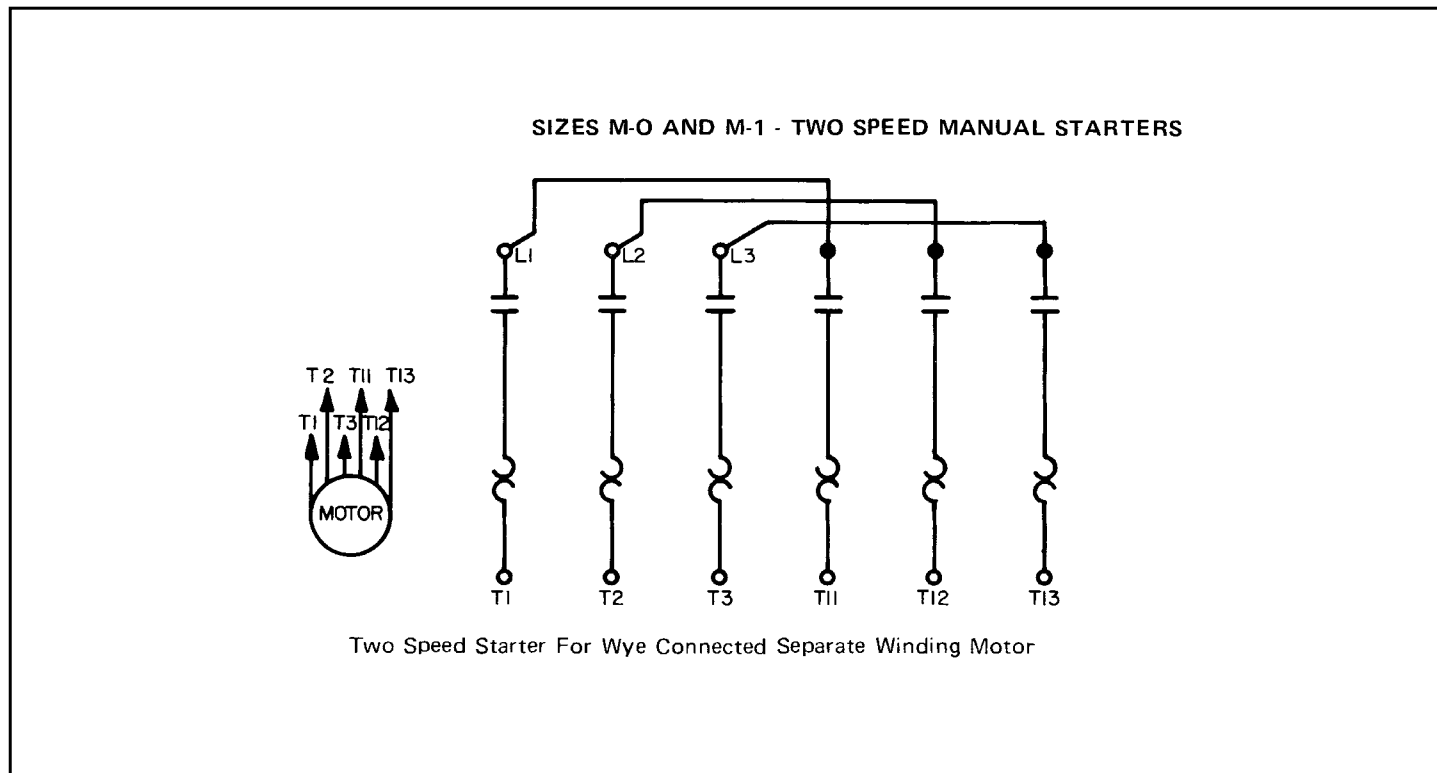

534

FIGURE 8.15 Medium-voltage motor controllers.

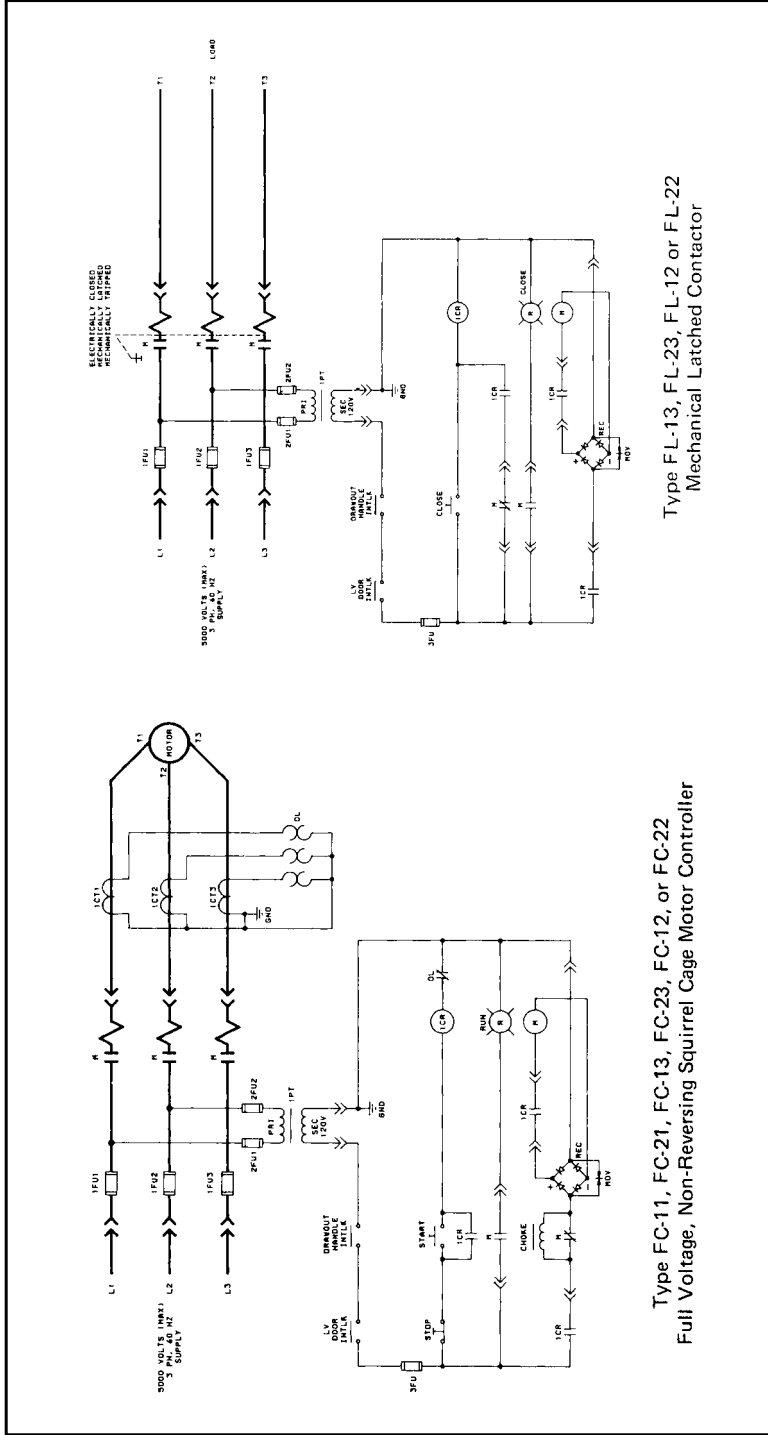

Type FC-11, FC-21, FC-13, FC-23, FC-12, or FC-22
Full Voltage, Non-Reversing Squirrel Cage Motor Controller

Type FL-13, FL-23, FL-12 or FL-22
Mechanical Latched Contactor

FIGURE 8.15 Medium-voltage motor controllers. (Continued)

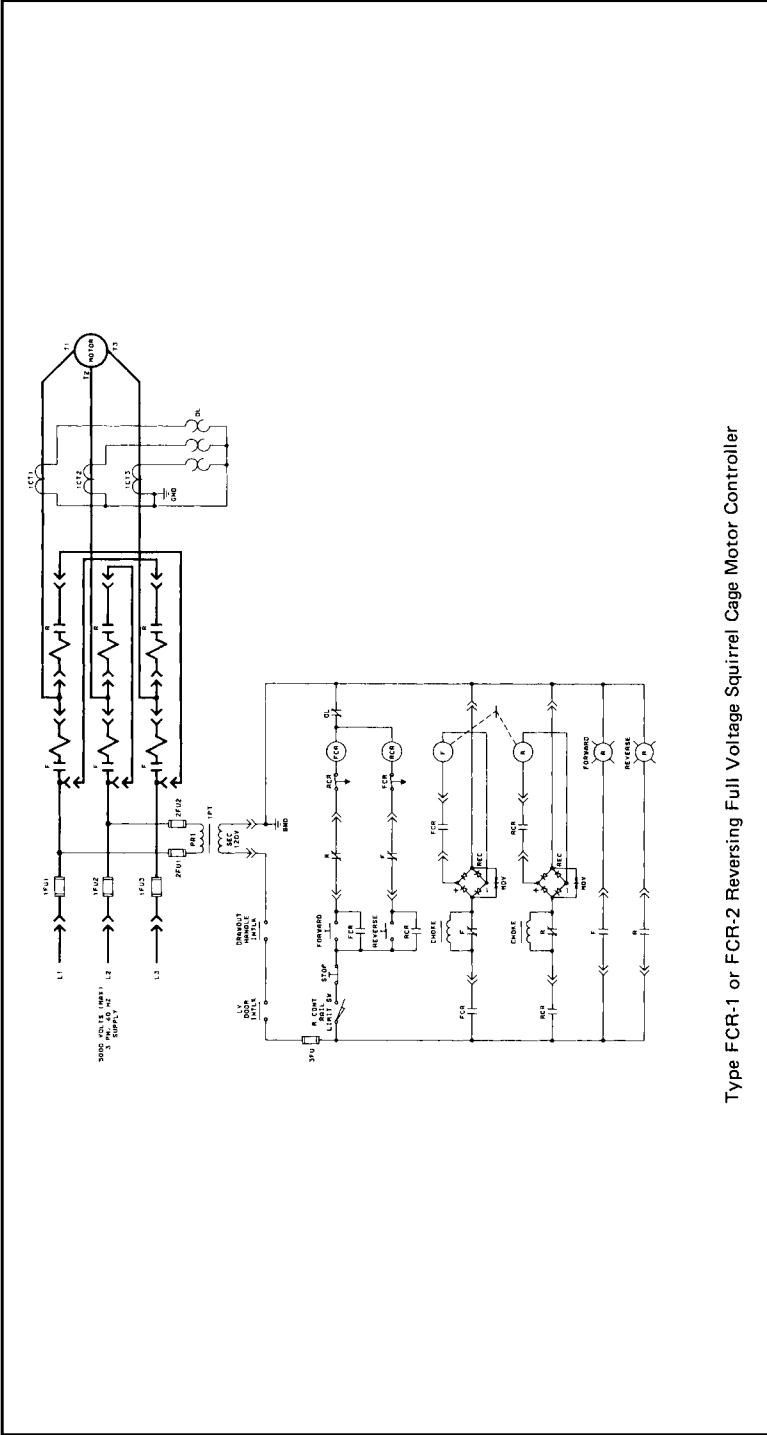

Type FCR-1 or FCR-2 Reversing Full Voltage Squirrel Cage Motor Controller

FIGURE 8.15 Medium-voltage motor controllers. (Continued)

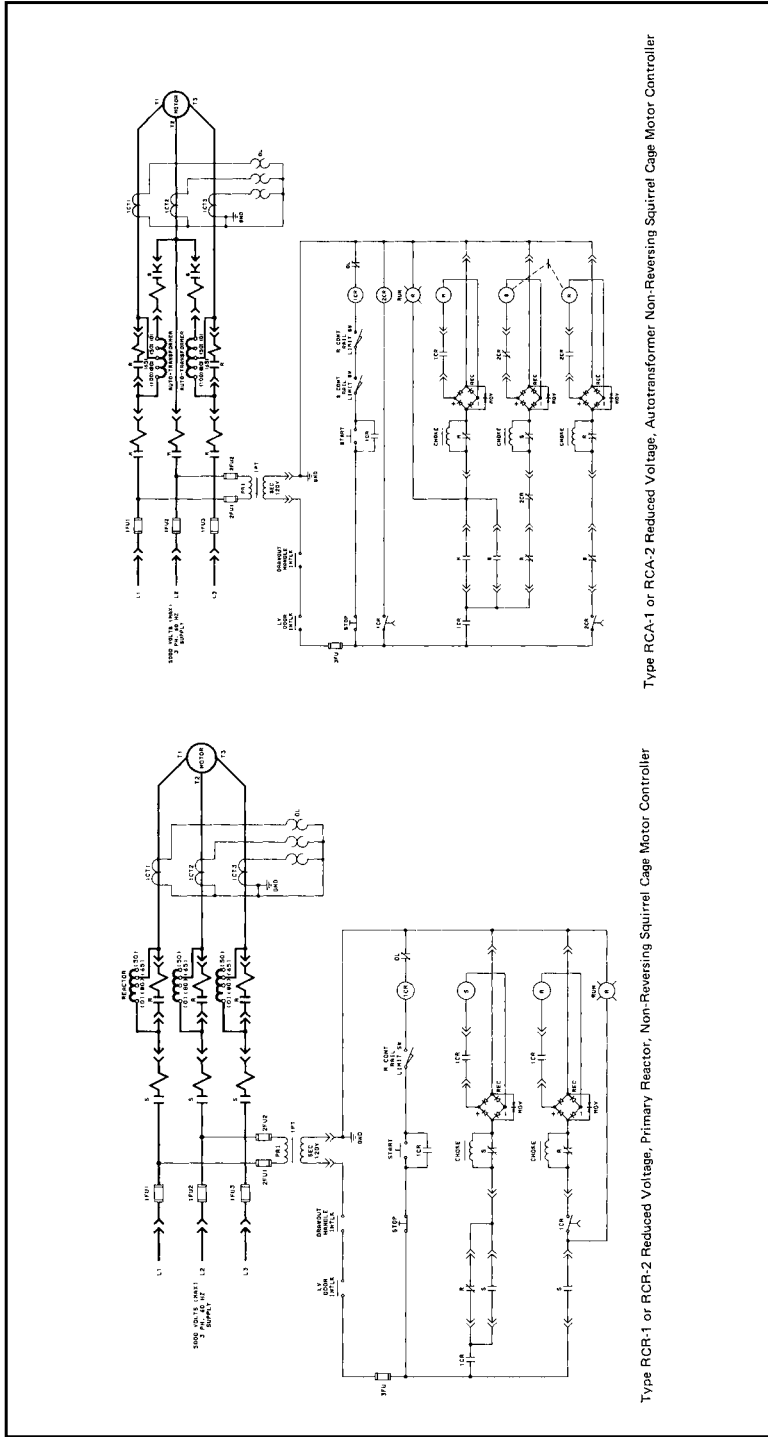

Type RCR-1 or RCR-2 Reduced Voltage, Primary Reactor, Non-Reversing Squirrel Cage Motor Controller

Type RCA-1 or RCA-2 Reduced Voltage, Autotransformer, Non-Reversing Squirrel Cage Motor Controller

FIGURE 8.15 Medium-voltage motor controllers. (Continued)

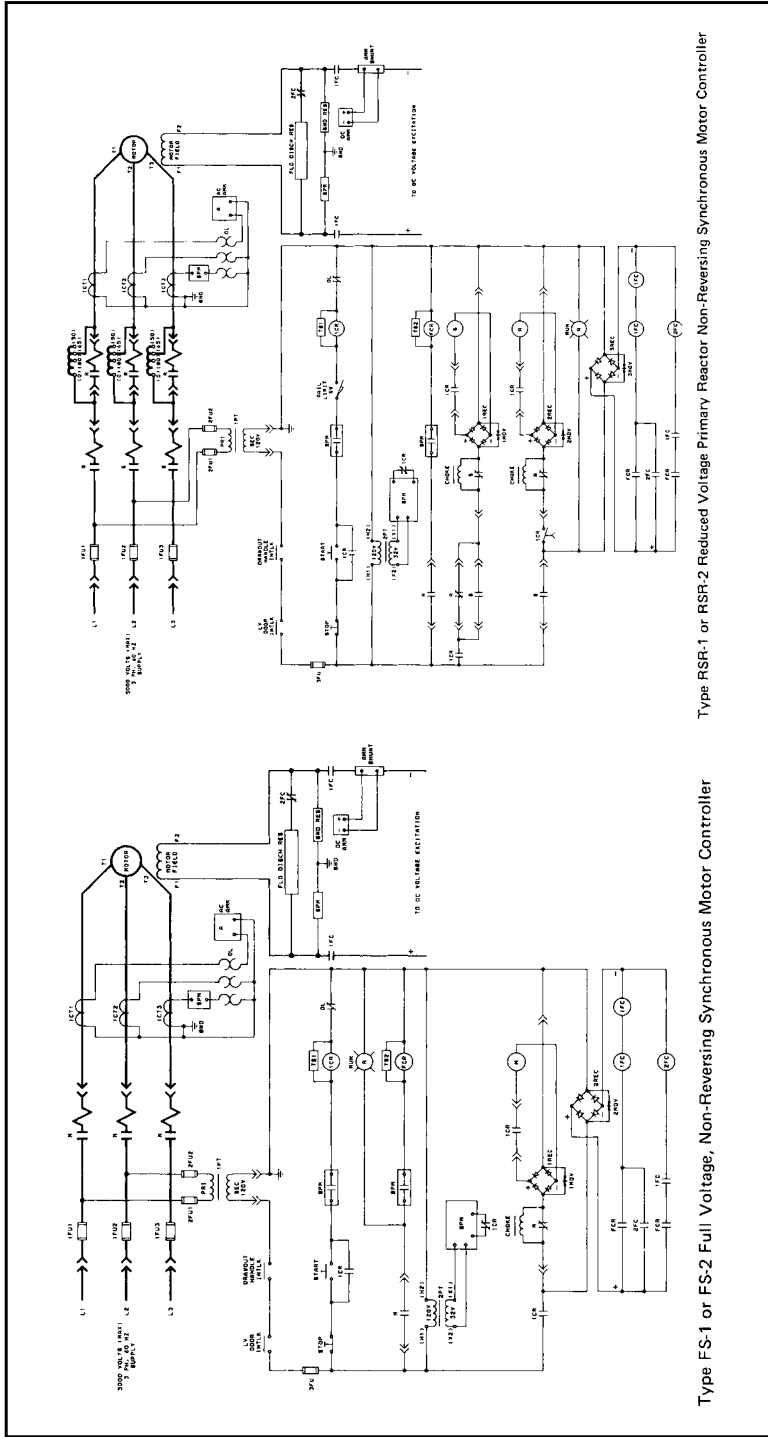

Type RSR-1 or RSR-2 Reduced Voltage Primary Reactor Non-Reversing Synchronous Motor Controller

Type FS-1 or FS-2 Full Voltage, Non-Reversing Synchronous Motor Controller

FIGURE 8.15 Medium-voltage motor controllers. (Continued)

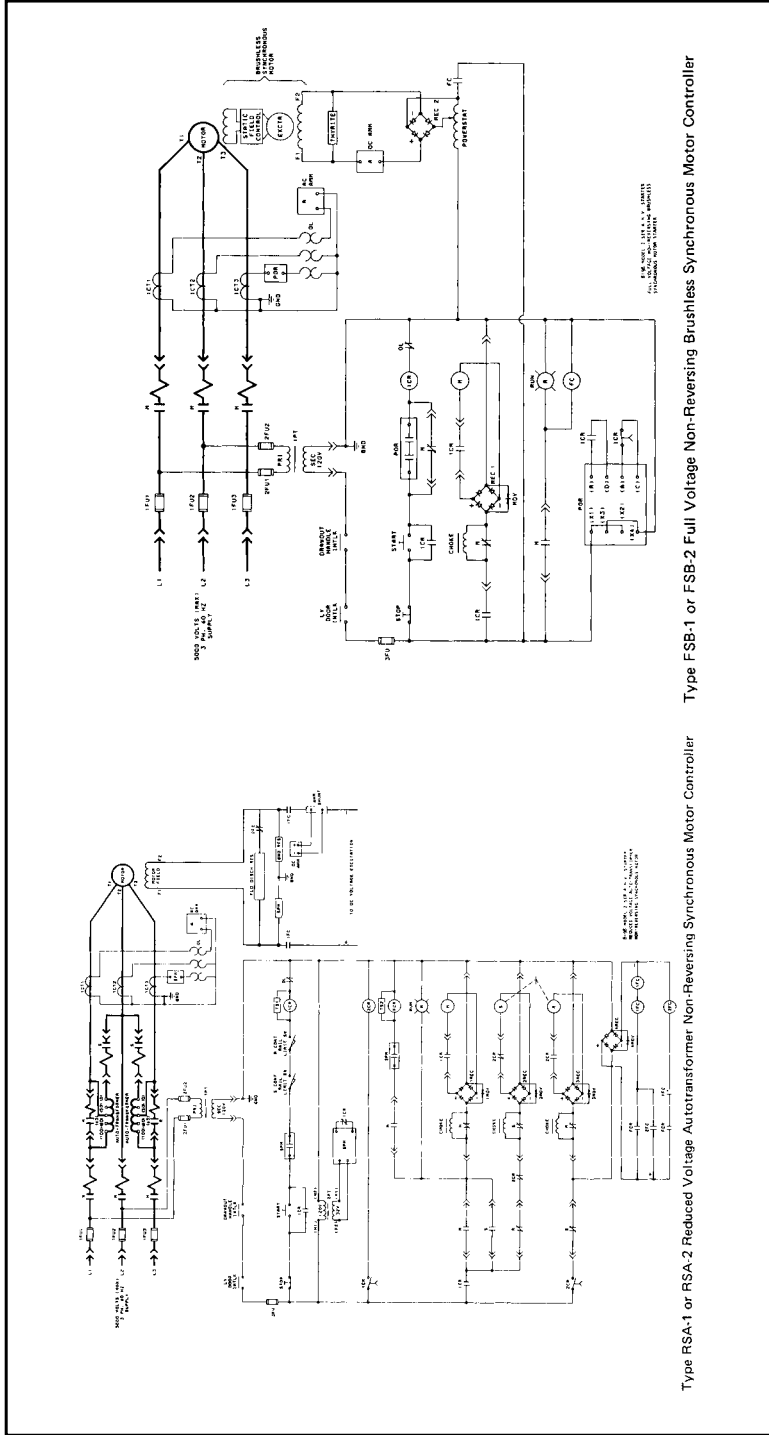

FIGURE 8.16 Reduced-voltage controllers.

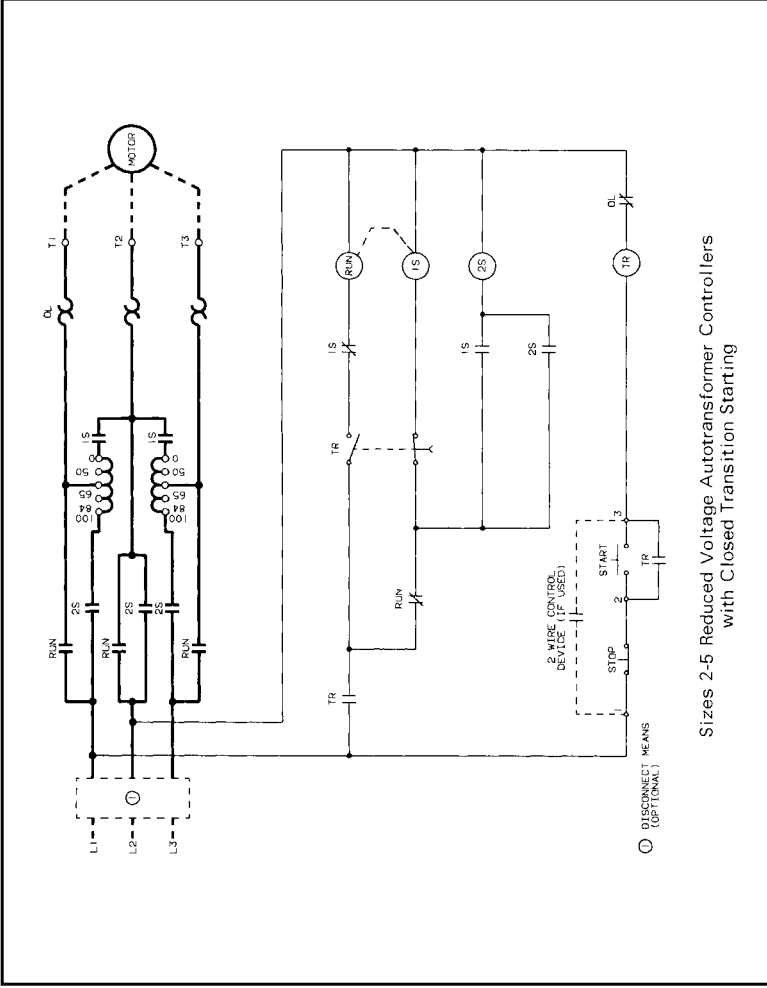
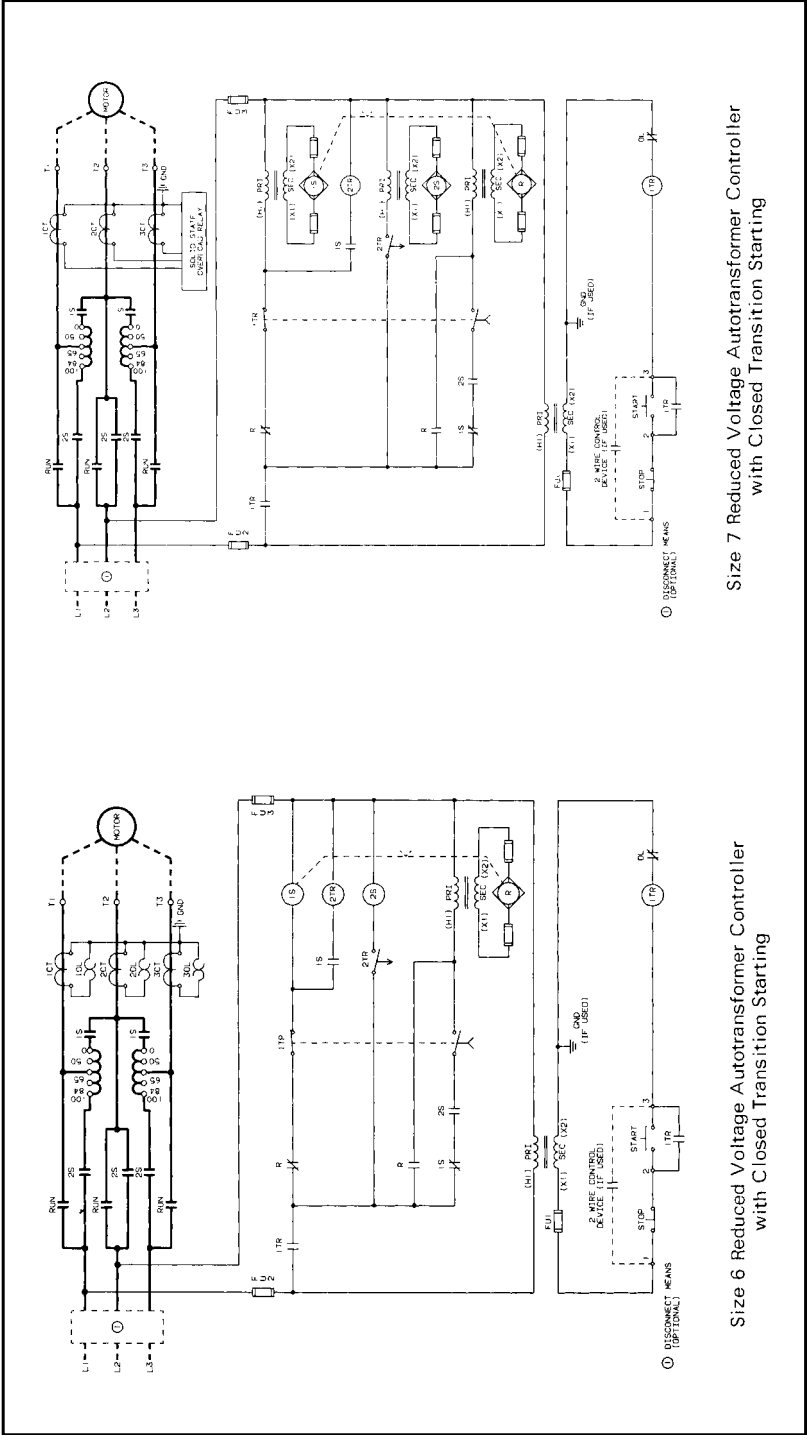

FIGURE 8.16 Reduced-voltage controllers. (Continued)



Size 7 Reduced Voltage Autotransformer Controller with Closed Transition Starting

Size 6 Reduced Voltage Autotransformer Controller with Closed Transition Starting

FIGURE 8.16 Reduced-voltage controllers. (Continued)

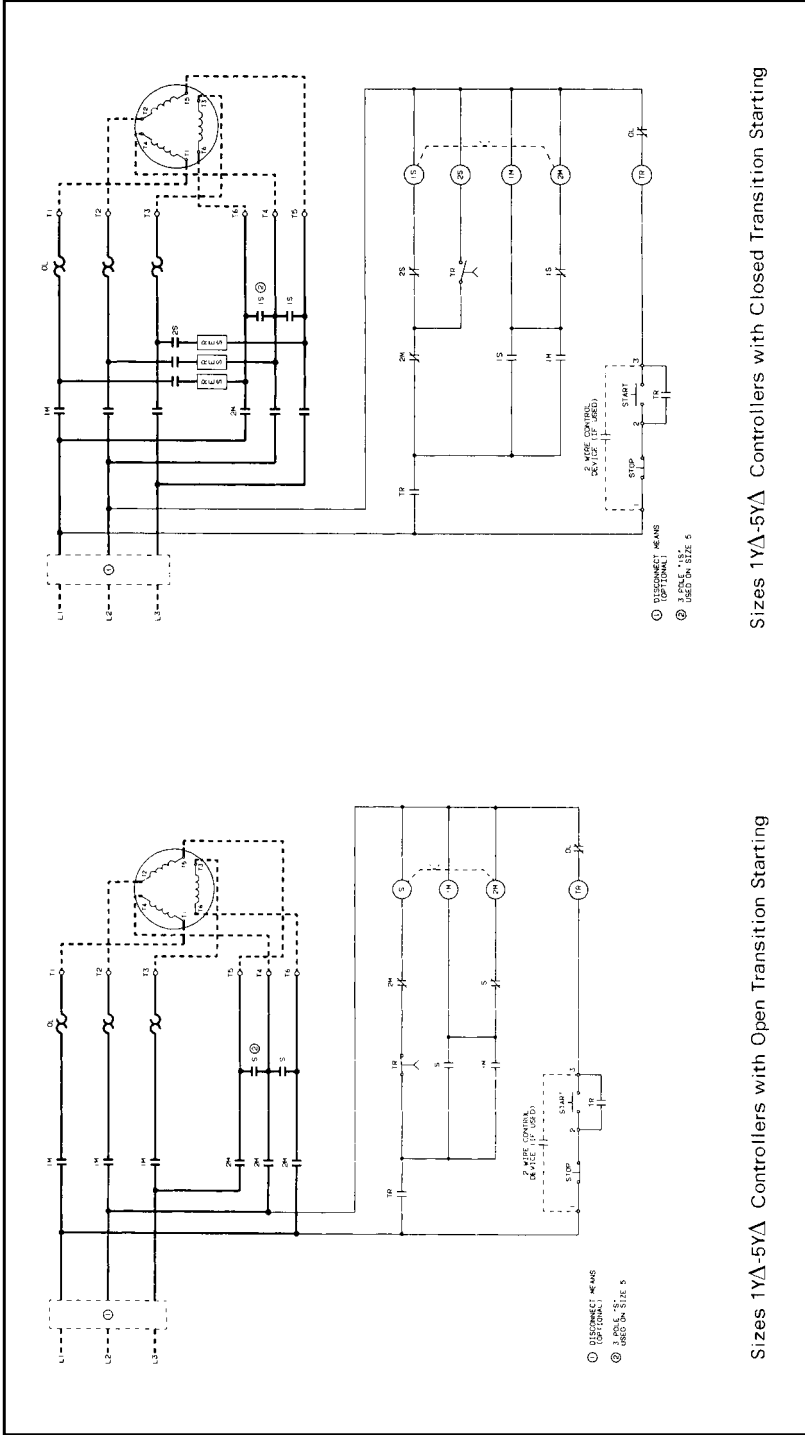

Sizes 1YΔ-5YΔ Controllers with Open Transition Starting

Sizes 1YΔ-5YΔ Controllers with Closed Transition Starting

FIGURE 8.16 Reduced-voltage controllers. (Continued)

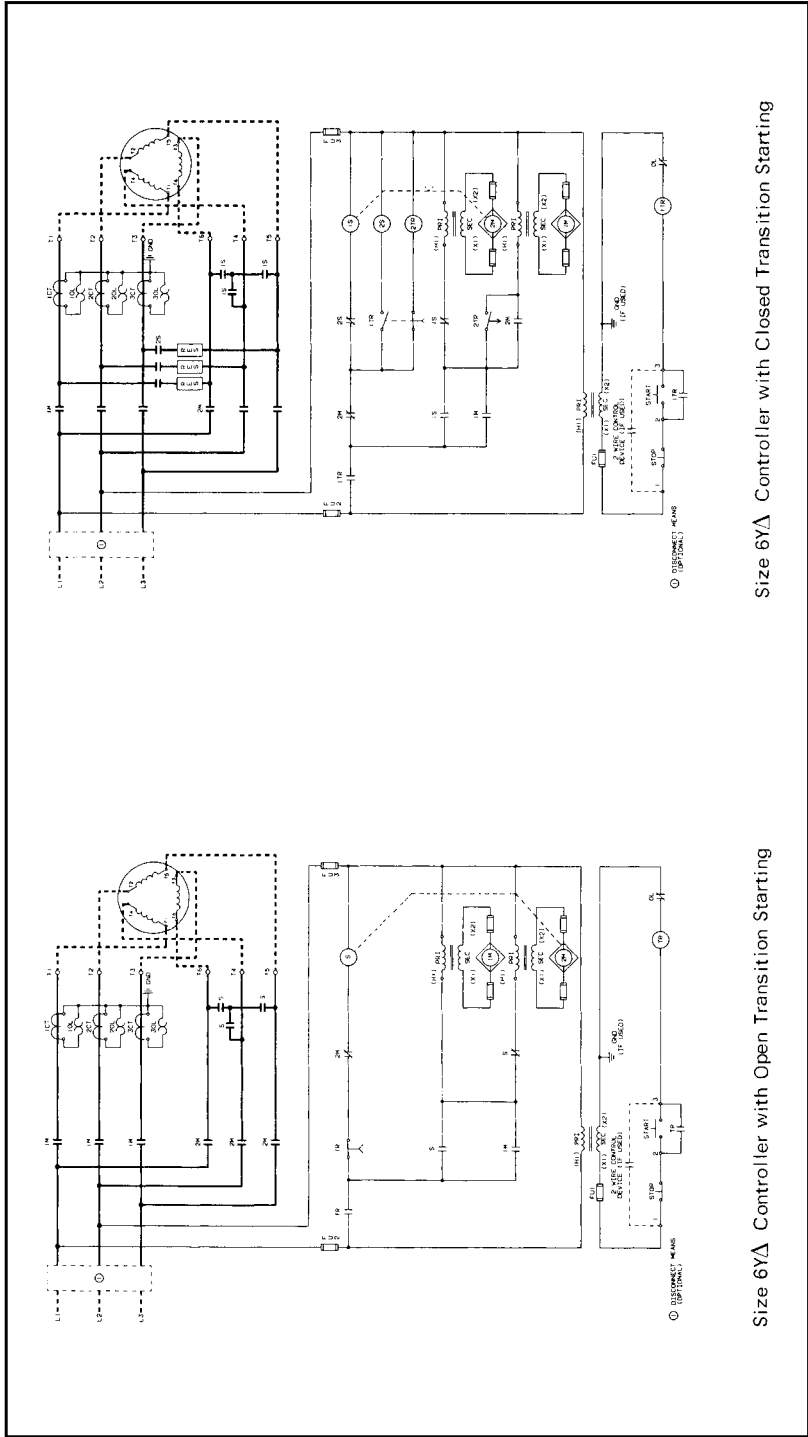

Size 6VA Controller with Closed Transition Starting

Size 6VA Controller with Open Transition Starting

FIGURE 8.16 Reduced-voltage controllers. (Continued)

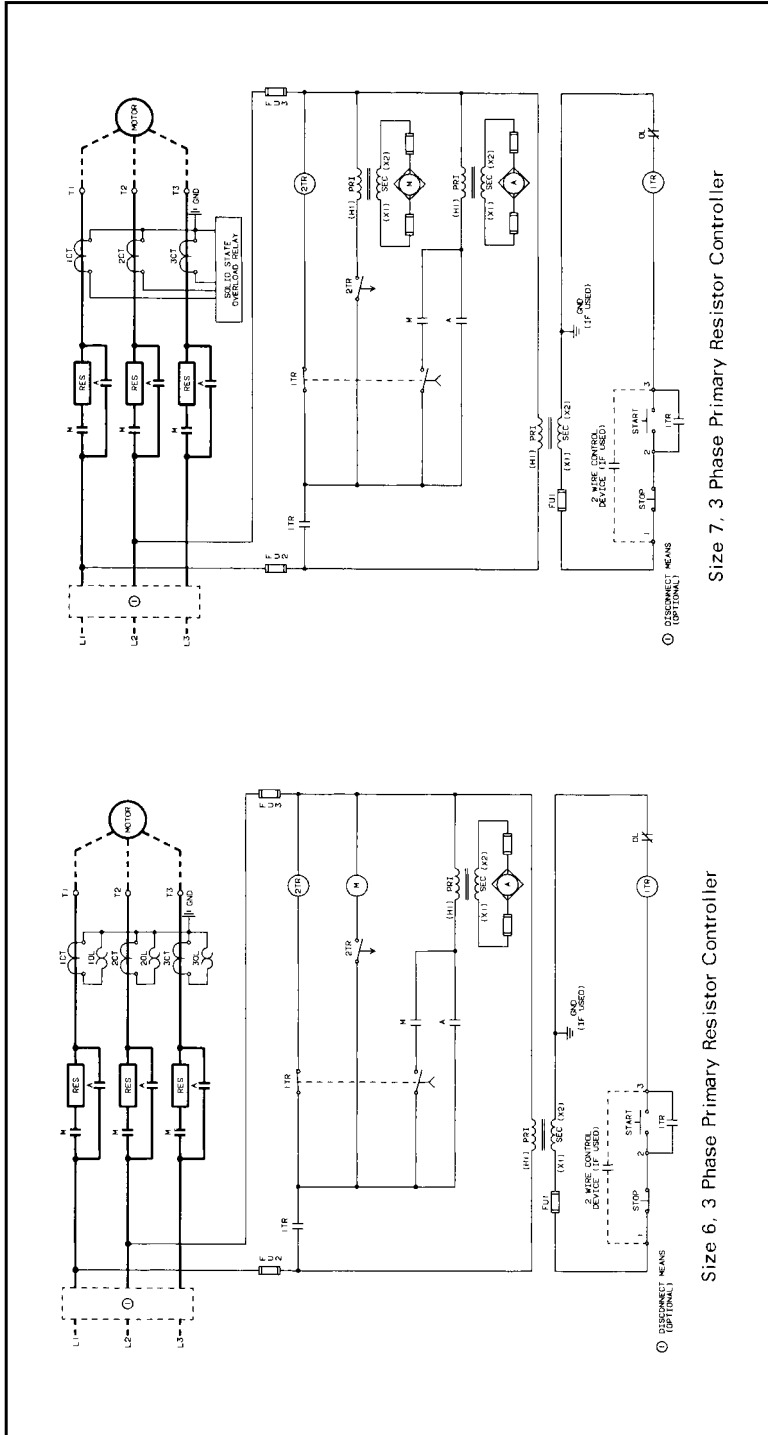

FIGURE 8.16 Reduced-voltage controllers. (Continued)

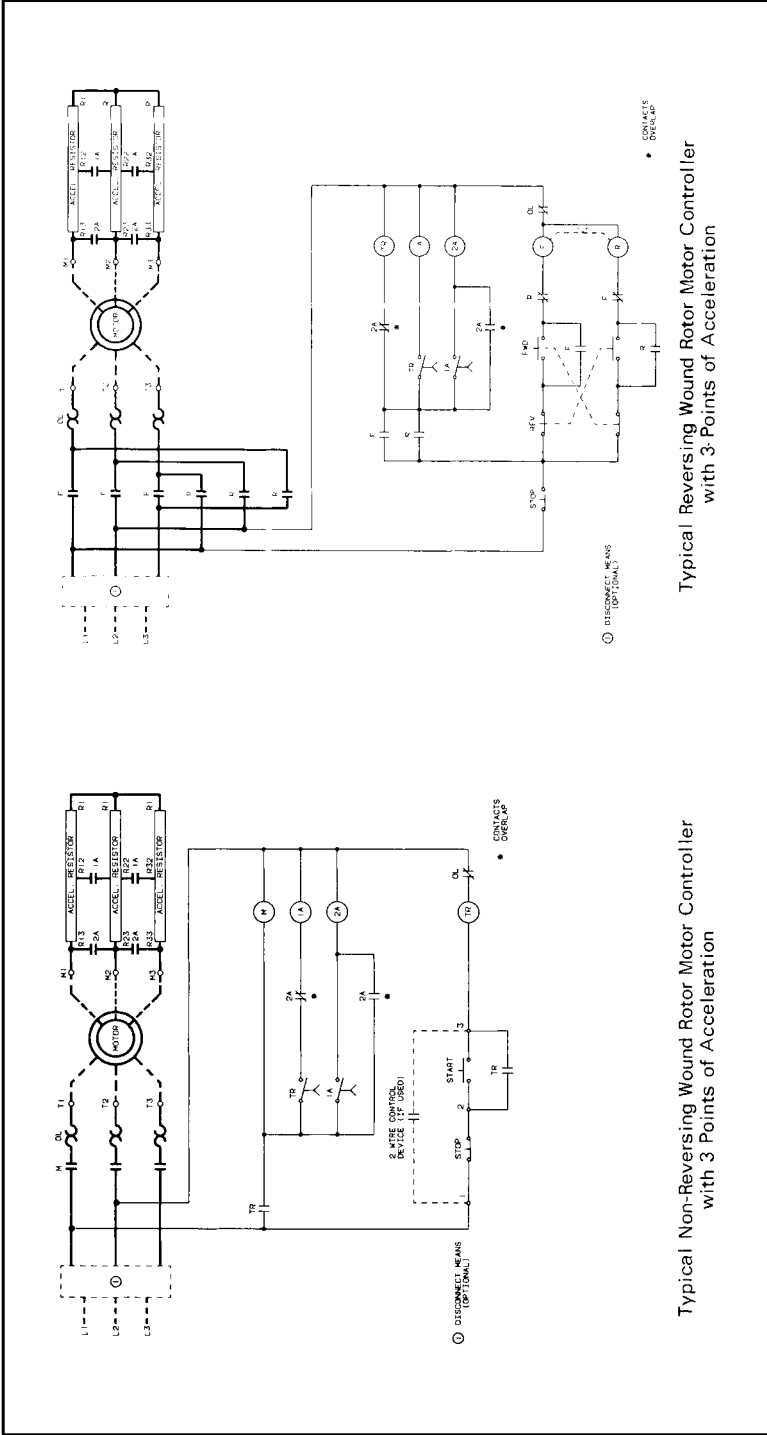

FIGURE 8.17 Solid-state reduced-voltage controllers.

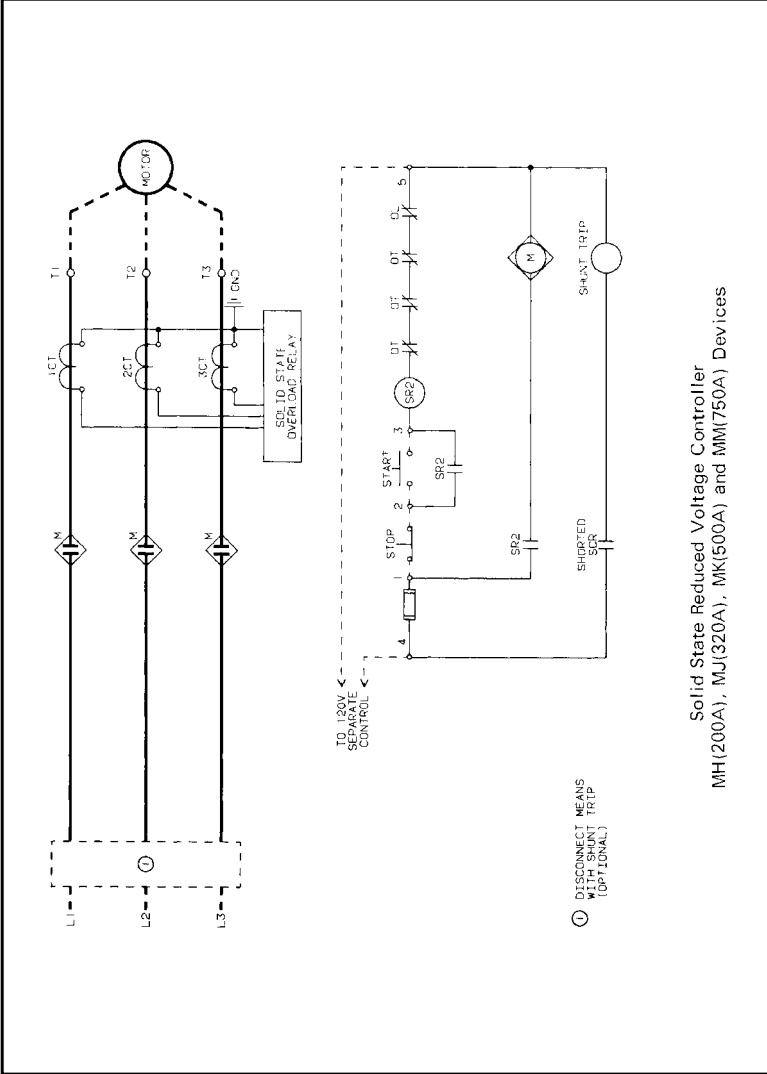
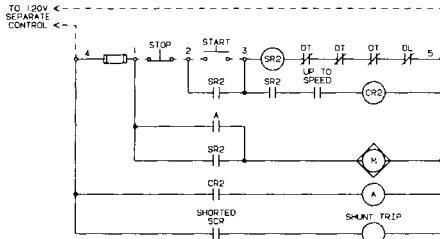
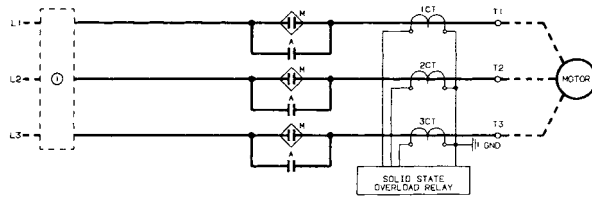
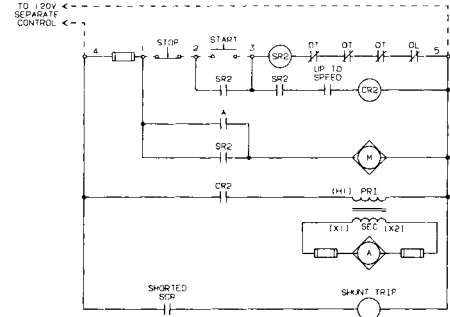
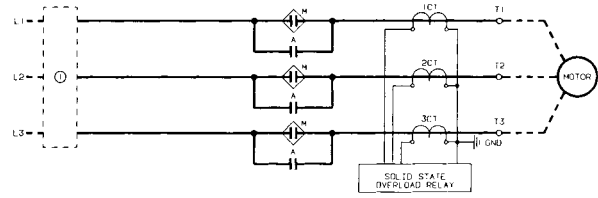

FIGURE 8.17 Solid-state reduced-voltage controllers. (*Continued*)



① DISCONNECT MEANS WITH SHUNT TRIP (OPTIONAL)

Solid State Reduced Voltage Controllers with a Shunting Contactor MH(200A) Device



① DISCONNECT MEANS WITH SHUNT TRIP (OPTIONAL)

Solid State Reduced Voltage Controllers with a Shunting Contactor MJ(320A), MK(500A) and MM(750A) Devices

FIGURE 8.17 Solid-state reduced-voltage controllers. (*Continued*)

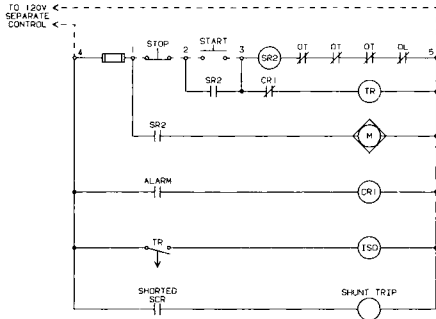
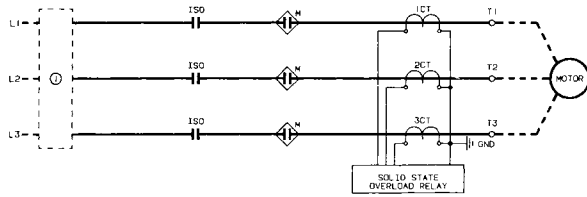

⊙ DISCONNECT MEANS WITH SHUNT TRIP (OPTIONAL)

Solid State Reduced Voltage Controllers with an Isolation Contactor MH(200A) Device

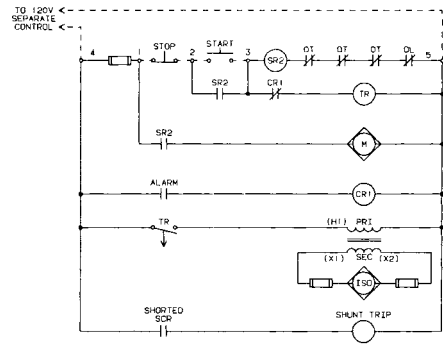
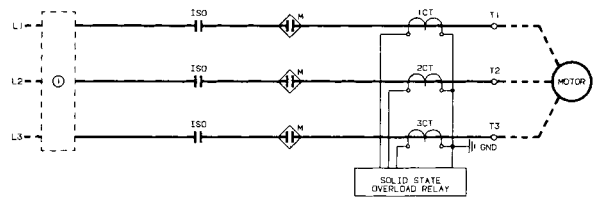

⊙ DISCONNECT MEANS WITH SHUNT TRIP (OPTIONAL)

Solid State Reduced Voltage Controllers with an Isolation Contactor MJ(320A), MK(500A) and MM(750A) Devices

548



FIGURE 8.17 Solid-state reduced-voltage controllers. (*Continued*)

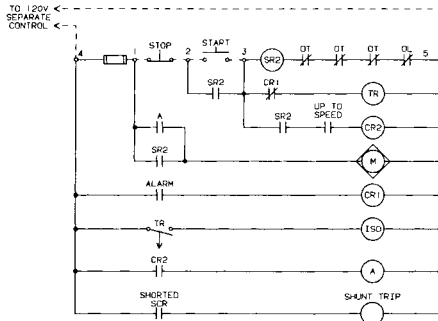
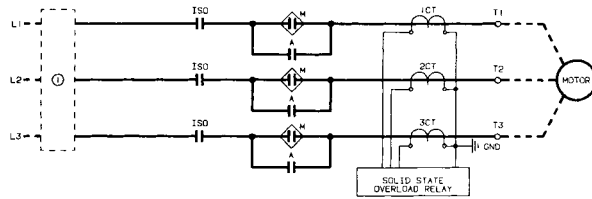

Solid State Reduced Voltage Controllers with a Shorting Contactor and an Isolation Contactor MH(200A) Device

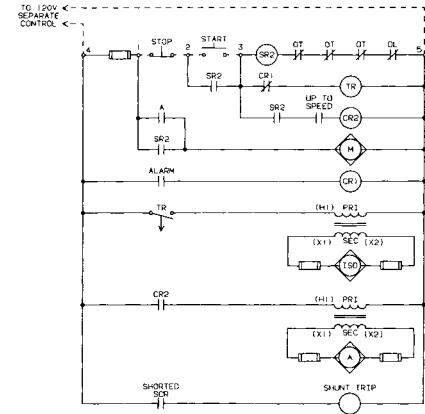
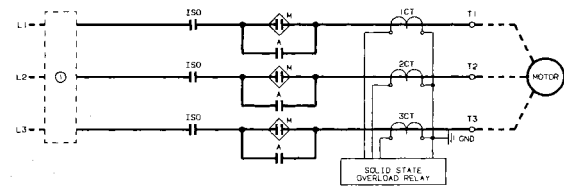

Solid State Reduced Voltage Controllers with a Shorting Contactor and an Isolation Contactor MJ(320A), MK(500A) and MM(750A) Devices

⊖ DISCONNECT MEANS WITH SHUNT TRIP (OPTIONAL)

⊖ DISCONNECT MEANS WITH SHUNT TRIP (OPTIONAL)

8.6 ELEVATOR RECALL SYSTEMS

Elevator recall systems are discussed here rather than under Fire Alarm Systems in Chapter 7 because they can be installed as a stand-alone system, even though they are generally a part of a fire alarm system. Also, several codes are applicable to the installation of these systems, specifically ANSI/ASME A17.1, Safety Code for Elevators and Escalators; NFPA 72, National Fire Alarm Code; NFPA 13, Standard for Installation of Sprinklers; and NFPA 101, Life Safety Code—to which the reader is referred for complete details.

Further, applying these codes properly in combination can be problematic (for example, whether sprinklers are present), coupled with the requirements of the authority having jurisdiction (which are generally more stringent).

Briefly stated, ANSI/ASME A17.1 is written so as to ensure that an elevator car will not stop and open the door on a fire-involved floor by requiring elevators to be recalled nonstop to a designated safe floor when smoke detectors located in elevator lobbies, other than the designated level, are actuated. When the smoke detector at the designated level is activated, the cars return to an alternate level approved by the enforcing authority.

If the elevator is equipped with front and rear doors, it is necessary to have smoke detectors in both lobbies at the designated level.

Activation of a smoke detector in any elevator machine room, except a machine room at the designated level, shall cause all elevators having any equipment located in that machine room, and any associated elevators of a group automatic operation, to return nonstop to the designated level. When a smoke detector in an elevator machine room is activated that is at the designated level, with the other conditions being the same as above, the elevators shall return nonstop to the alternate level, or the appointed level when approved by the authority having jurisdiction.

NFPA 72 requires that in facilities without a building fire alarm system, these smoke detectors shall be connected to a dedicated fire alarm system control unit that shall be designated as “elevator recall control and supervisory panel.” Thus, the stand-alone operation noted previously.

As noted, the foregoing is by no means complete, but captures the intent and basic cause-and-effect relationship between an elevator recall system's smoke detectors and elevator operation under the various stated conditions.

Figure 8.18 shows a typical elevator recall/emergency shutdown schematic. Please note that the authority having jurisdiction required that the elevator recall smoke detectors in this application be independent of the building fire alarm system smoke detectors. Figure 8.19 shows a typical elevator hoistway/machine room device installation detail for the same project application shown in Figure 8.18. Note that

FIGURE 8.18 Typical elevator recall/emergency shutdown schematic.

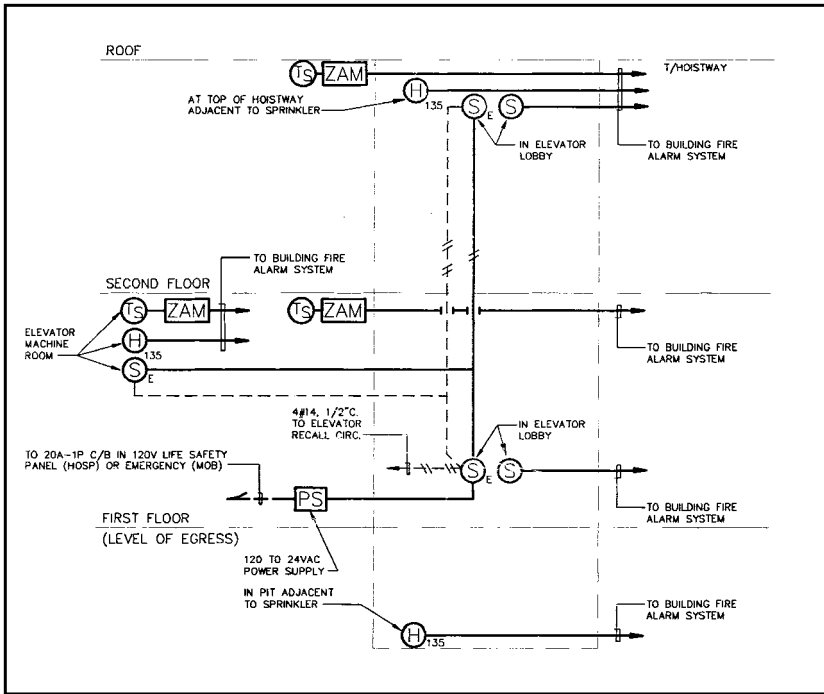

the fire alarm system is fully addressable and that the elevator machine rooms are at the designated level for egress.

8.7 MEDIUM-VOLTAGE CABLE AND ENGINEERING DATA

The following provides data on medium-voltage cable and engineering data. Although it would be nice to provide data for virtually every requirement, it is not the intent of this handbook. It would be impossible to show all such data. What is provided is most likely to be required in most situations. You might consider it a more narrow “bell curve” of data.

Ampacities

Experience has shown that most applications, usually college/university, hospital, or similar campus situations, involve underground distribution (conductors in duct bank or direct-buried). The most widely used con-

FIGURE 8.19 Typical elevator hoistway/machine room device installation detail.

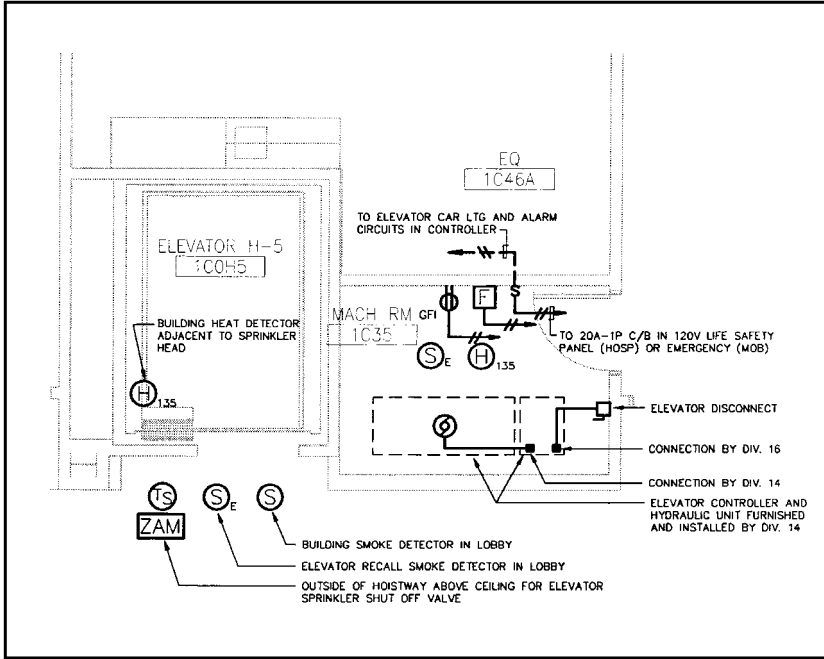

ductors are EPR-insulated, single conductors paralleled or triplexed, in conduit or duct bank. They may also be direct-buried or in air. The voltage class is usually 15 kV, although it may typically be 5 to 25 kV. With these parameters in mind, the following ampacity tables (Table 8.4 and Figures 8.20 and 8.21) are provided with the installation details upon which they are based.

Allowable Short-Circuit Currents

As indicated in Chapter 3, short-circuit currents for low-voltage cables (600 V and below) are not of significant concern for the cable withstand capability; however, for medium-voltage cable, it is of much greater concern. With this in mind, the following is provided in Figure 8.22.

DC Field Acceptance Testing

It is general practice, and obviously empirical, to relate the field test voltage upon installation to the final factory-applied DC potentials by using a factor of 80 percent. Table 8.5 shows these values.

FIGURE 8.20 Typical installations—underground in ducts.

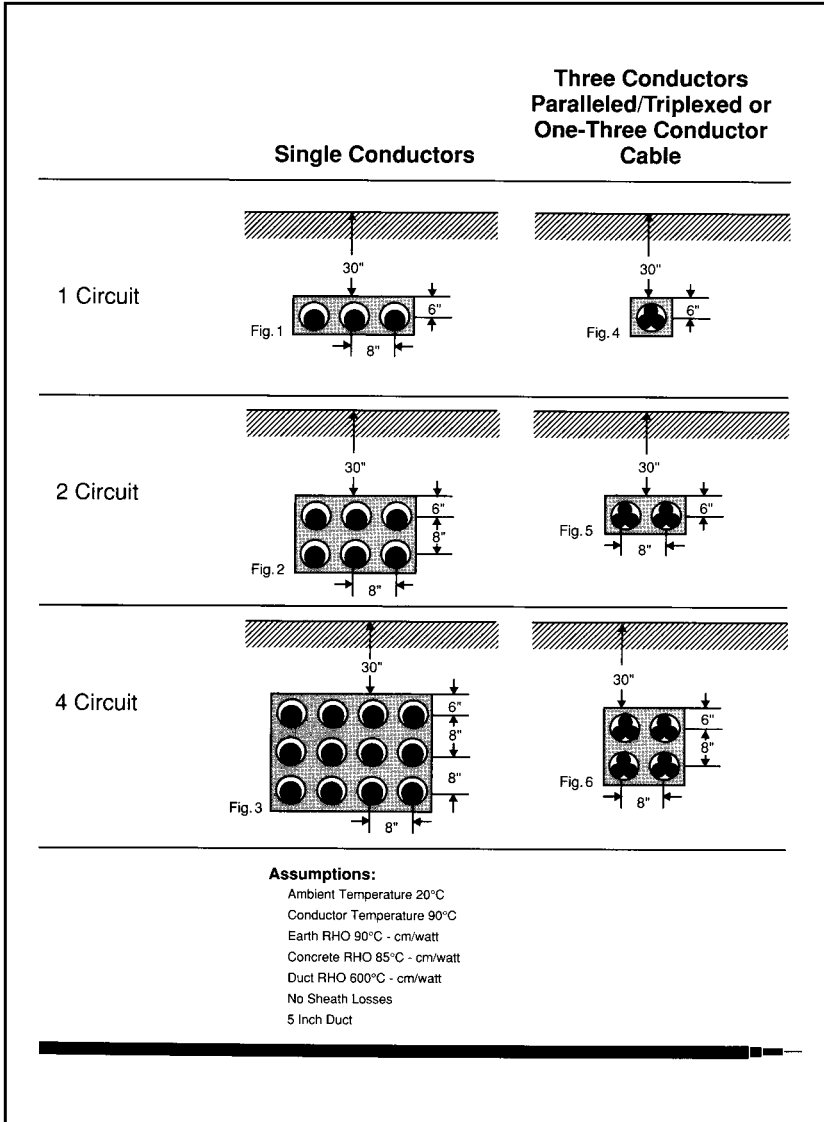

FIGURE 8.21 Typical installations—direct-buried and in-air.

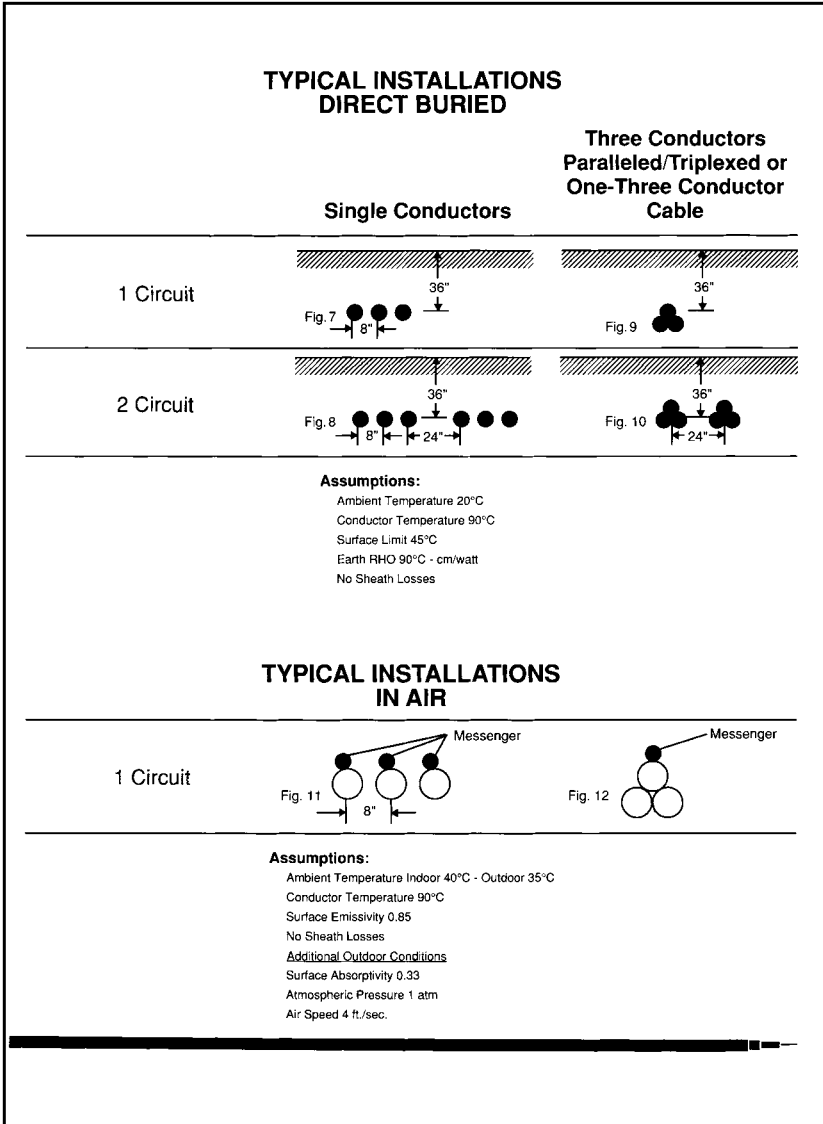

FIGURE 8.22 Allowable short-circuit currents for insulated copper conductors.

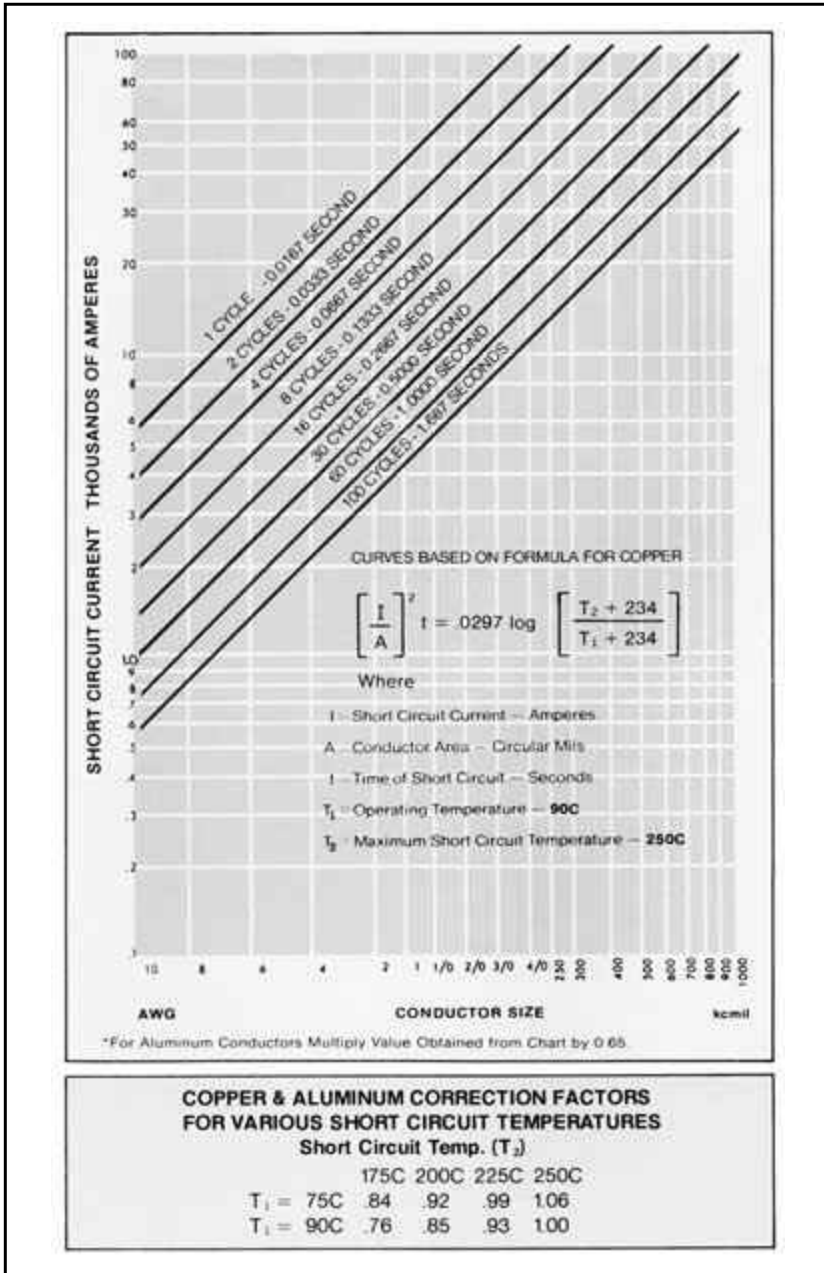

TABLE 8.4 Triplexed or Paralleled Cable Ampacities, Single Conductors, Copper and Aluminum, EPR Insulated, 5 to 35 kV

Copper Conductors

Conductor Size AWG/kcmil	Underground In Ducts - Three 1/C Cable Per Duct									Direct Buried Three 1/C Cable Per Circuit						In Air Three Singles	
	1 Circuit Fig. 4 Load Factor			2 Circuits Fig. 5 Load Factor			4 Circuits Fig. 6 Load Factor			1 Circuit Fig. 9 Load Factor			2 Circuits Fig. 10 Load Factor			Fig. 12 Indoor	Fig. 12 Outdoor
	50	75	100	50	75	100	50	75	100	50	75	100	50	75	100		
6	101	97	92	97	91	84	91	81	73	139	114	92	135	104	83	101	130
4	131	125	119	126	117	108	117	105	93	182	146	117	175	132	105	133	171
2	174	166	156	167	154	141	154	136	120	234	189	152	224	170	136	179	219
1	199	189	178	190	175	160	175	154	135	268	214	172	254	192	153	205	252
1/0	227	215	202	216	199	181	198	174	153	306	242	194	287	216	173	235	289
2/0	259	245	230	246	226	205	225	197	173	351	273	219	324	244	195	270	332
3/0	295	279	261	280	256	233	256	223	195	402	308	247	366	275	220	311	382
4/0	337	317	297	319	291	264	290	253	221	460	349	279	413	310	248	358	439
250	372	350	326	352	320	289	319	277	241	504	382	306	452	339	271	398	485
350	450	422	392	424	384	346	383	331	287	603	455	364	539	404	322	488	594
500	549	513	475	516	465	417	463	398	344	727	547	437	647	483	385	605	735
750	680	633	584	636	571	510	568	485	418	892	671	536	791	590	470	760	905
1000	786	728	670	733	654	582	651	533	474	1023	767	612	903	672	535	893	1056

TABLE 8.4 Triplexed or Paralleled Cable Ampacities, Single Conductors, Copper and Aluminum, EPR Insulated, 5 to 35 kV (*Continued*)

Aluminum Conductors

Conductor Size AWG/kcmil	Underground in Ducts - Three 1/C Cable Per Duct									Direct Buried Three 1/C Cable Per Circuit						In Air Three Singles	
	1 Circuit Fig. 4 Load Factor			2 Circuits Fig. 5 Load Factor			4 Circuits Fig. 6 Load Factor			1 Circuit Fig. 9 Load Factor			2 Circuits Fig. 10 Load Factor			Fig. 12 Indoor	Fig. 12 Outdoor
	50	75	100	50	75	100	50	75	100	50	75	100	50	75	100		
6	76	73	70	74	69	64	69	62	56	109	88	71	105	80	64	77	101
4	99	95	90	96	89	83	89	80	71	142	112	90	135	102	81	101	133
2	134	127	120	128	118	109	118	105	93	182	146	118	173	131	105	137	171
1	153	145	137	146	135	123	134	119	105	208	165	133	196	148	119	157	197
1/0	174	165	156	166	153	140	153	134	118	239	187	150	222	167	134	181	226
2/0	199	188	177	189	174	158	173	152	134	273	211	169	250	189	151	208	260
3/0	227	215	201	216	198	180	197	173	151	313	238	191	283	213	170	239	299
4/0	260	245	229	246	225	204	224	196	171	356	270	216	320	241	192	276	344
250	286	270	252	271	247	224	246	214	187	390	295	236	350	263	210	307	381
350	349	327	304	329	298	269	297	257	223	468	353	283	419	314	250	378	467
500	428	400	371	402	363	326	361	311	269	567	427	341	506	378	301	472	581
750	539	501	463	504	452	404	449	384	330	704	528	421	624	465	370	608	743
1000	629	584	537	587	524	466	520	442	379	819	614	490	724	539	429	717	855

TABLE 8.5 High-Voltage Field Acceptance Test Prior to Being Placed in Service

Rated Voltage Phase to Phase	dc Hi-Pot Test (15 Minutes)		dc Hi-Pot Test	
	Wall - mils	kV	Wall - mils	kV
5000	90	25	115	35
8000	115	35	140	45
15000	175	55	220	65
25000	260	80	320	95
28000	280	85	345	100
35000	345	100	420	125
46000	445	130	580	170
69000	650	195	650	195

Note: *If the leakage current quickly stabilizes, the duration may be reduced to 10 minutes.

Installation Practices

Conduits or ducts should be properly constructed having smooth walls and of adequate size as determined by the overall cable diameter and recommended percentage fill of conduit area.

For groups or combinations of cables it is recommended that the conduit or tubing be of such size that the sum of the cross-sectional areas of the individual cables will not be more than the percentage of the interior cross-sectional area of the conduit or tubing as shown in Tables 8.7 through 8.10.

Clearance

Clearance refers to the distance between the uppermost cable in the conduit and the inner top of the conduit. Clearance should be ¼ in at minimum and up to 1 in for large-cable installations or installations involving numerous bends. Figure 8.23 shows how it is calculated.

When calculating clearance, ensure all cable diameters are equal. Use triplexed configuration formula if you are in doubt. Again, the cables may be of single- or multiple-conductor construction.

Jam Ratio

Jamming is the wedging of three cables lying side by side in a conduit. This usually occurs when cables are being pulled around bends or when cables twist.

Jam ratio is calculated by slightly modifying the ratio used to measure

Jacket Materials—Relative Performance

TABLE 8.6 Jacket Materials Selection Chart—Relative Performance Data

Mechanical	PVC	Polyethylene	Neoprene	Chlorosulphonated Polyethylene	Thermoplastic CPE
Abrasion Resistance Tensile Strength Elongation Compression Resistance Flexibility	Good Excellent Good Good Good	Excellent Excellent Excellent Excellent Fair	Good Excellent Excellent Excellent Excellent	Good Excellent Excellent Excellent Excellent	Excellent Good Good Good Fair
Environmental					
Flame	Good	Poor	Excellent	Excellent	Good
Moisture Fresh or salt water	Good	Exceptional	Good	Excellent	Excellent
Petroleum oils Motor oil Fuel oil Crude oil Creosote	Good Poor	Excellent (Slight swelling above 60°C) Good	Good Fair	Good Fair	Good (Poor above 110°C) Good
Paraffinic Hydrocarbons Gasoline Kerosene	Good	Excellent (Slight swelling at higher temperatures)	Poor	Poor	Excellent (Slight swelling at higher temperatures)
Alcohols Isopropyl Wood Grain	Fair	Good	Fair	Good	Good
Mineral Acids Sulfuric Nitric Hydrochloric	Excellent	Excellent	Excellent	Excellent	Excellent
Fixed Alkalies Sodium hydroxide (lye) Potassium hydroxide (potash) Calcium hydroxide (lime)	Good	Excellent	Good	Excellent	Excellent
Ketones Acetone Methyl ethyl ketone (MEK)	Poor	Good	Poor	Fair	Good
Esters Ethyl Acetate Most lacquer thinners	Poor	Good	Poor	Fair	Good
Halogenated Hydrocarbons Chloroform Carbon Tetrachloride Methyl chloride	Poor	Poor	Poor	Poor	Poor
General					
Leaves protective residue after combustion	Yes	No	Yes	Yes	Yes
Oxygen Index (ASTM D-2863)	23-30%	17-18%	31-39%	30-36%	30-34%
Halogen content - % Wt.	26	0	18	14	18-20
Minimum installation temperature	14F (-10C)	-40F (-40C)	-4F (-20C)	-4F (-20C)	-40F (-40°C)
Dimensional stability under heat	Fair	Fair	Excellent	Excellent	Fair
Maximum operating temperature	75C (167F)	75C (167F)	90C (194F)	90C (194F)	75 C (167F)
NOTE: When cables are to be installed in cold weather, they should be kept in heated storage for at least 24 hrs. before installation.					

configuration (D/d). A value of $1.05D$ is used for the inner diameter of the conduit, because bending a cylinder creates an oval cross-section in the bend ($1.05D/d$).

- If $1.05D/d$ is larger than 3.0, jamming is impossible.
- If $1.05D/d$ is between 2.8 and 3.0, serious jamming is probable.
- If $1.05D/d$ is less than 2.5, jamming is impossible but clearance should be checked.

TABLE 8.7 Dimensions of Conduit

Nominal size conduit inches	Internal diameter inches	Area square inches
1	1.049	0.86
1 1/4	1.380	1.50
1 1/2	1.610	2.04
2	2.067	3.36
2 1/2	2.469	4.79
3	3.068	7.38
3 1/2	3.548	9.90
4	4.026	12.72
5	5.047	20.00
6	6.065	28.89

TABLE 8.8 Maximum Percent Internal Area of Conduit or Tubing

	Number of cables				
	1	2	3	4	Over 4
Cables (not lead-covered)	53	31	40	40	40
Lead-covered cables	55	30	40	38	35

*This section summarizes procedures, calculations, and recommendations required for proper installation practices.

TABLE 8.9 Maximum Percent Internal Diameter of Conduit or Tubing

	Number of cables			
	1	2	3	4
Cables (not lead-covered)	72.8	39.3	36.5	31.6
Lead-covered cables	74.2	38.7	36.5	30.8

TABLE 8.10 Maximum Allowable Diameter (in Inches) of Individual Cables in Given Size Conduit

Non-metallic jacketed cable— all cables of same outside diameter				
Nominal size conduit	Number of cables having same O.D.			
	1	2*	3*	4*
1/2	0.453	0.244	0.227	0.197
3/4	0.600	0.324	0.301	0.260
1	0.763	0.412	0.383	0.332
1 1/4	1.010	0.542	0.504	0.436
1 1/2	1.173	0.633	0.588	0.509
2	1.505	0.812	0.754	0.653
2 1/2	1.797	0.970	0.901	0.780
3	2.234	1.206	1.120	0.970
3 1/2	2.583	1.395	1.296	1.121
4	2.930	1.583	1.470	1.273
5	3.675	1.985	1.844	1.595
6	4.416	2.385	2.215	1.916

NOTE: To determine the size conduit required for any number (n) of equal diameter cables in excess of four, multiply the diameter of one cable by $\sqrt{\frac{n}{4}}$

This will give the "equivalent" diameter of four such cables and the conduit size required for (n) cables may then be found by using the column for four cables.

*These diameters are based on percent fill only. The Jam Ratio, Conduit ID to Cable O.D., should be checked to avoid possible jamming.

Because there are manufacturing tolerances on cable, the actual overall diameter should be measured prior to computing the jam ratio.

Pulling Tensions

Most major cable manufacturers provide examples of pulling tension calculations in their catalogs and the reader should refer to these for preliminary calculations. It is recommended, however, that you provide to the cable manufacturer that you plan to use the necessary application data for calculations by them.

Minimum Bending Radii

Refer to Table 8.11 for information on minimum bending radii.

FIGURE 8.23 Clearance of cables in conduit.



# Of Conductors/Cables	Configuration	Formula
1		D-d
3	 CRADLED	$\frac{D}{2} - 1.366d + \frac{D-d}{2} \sqrt{1 - \left(\frac{d}{D-d}\right)^2}$
3	 TRIPLEXED	$\frac{D}{2} - \frac{d}{2} + \frac{D-d}{2} \sqrt{1 - \left[\frac{d}{2(D-d)}\right]^2}$

TABLE 8.11 Minimum Bending Radii—Power and Control Cables with Metallic Shielding or Armor

Type of Cable	Minimum Bending Radius as a Multiple of Cable Diameter	
	Power	Control
Armored, flat tape or wire type	12	12
Armored, smooth aluminum sheath, up to		
0.75 inches cable diameter	10*	10*
0.76 to 1.5 inches cable diameter	12	12
over 1.5 inches cable diameter	15	15
Armored, corrugated sheath or interlocked type	7	7
with shielded single conductor	12	12
with shielded multi-conductor	**	**
Non-armored, flat or corrugated		
tape shielded single conductor	12	12
tape shielded multi-conductor	**	**
multi-conductor overall tape shield	12	12
LCS with PVC jacket	15	15
Non-armored, flat strap shielded	8	—
* with shielded conductors 12		
** 12 times single conductor diameter or 7 times overall cable diameter — whichever is greater		
LCS = longitudinally applied corrugated shield		

8.8 HARMONIC EFFECTS AND MITIGATION

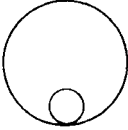
Introduction

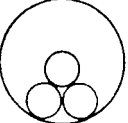
Harmonics are the result of nonlinear loads so prevalent with late-twentieth-century technology. Personal computers, adjustable speed drives, uninterruptible power supplies, to name a few, all have nonlinear load characteristics. What all nonlinear loads have in common is that they convert AC to DC and contain some kind of rectifier.

A sinusoidal system can supply nonsinusoidal current demands because any nonsinusoidal waveform can be generated by the proper combination of harmonics of the fundamental frequency. Each harmonic in the combination has a specific amplitude and phase relative to the fundamental. The particular harmonics drawn by a nonlinear load are a function of the rectifier circuit and are not affected by the type of load.

Harmonic Origins

Harmonics have two basic origins—current wave distortion and voltage wave distortion.

HARMONICS-PRODUCING EQUIPMENT (VOLTAGE DISTORTION)

- Uninterruptible power supplies
- Variable-frequency drives
- Large battery chargers
- Elevators
- Synchronous clock systems
- Radiology equipment
- Large electronic dimming systems
- Arc heating devices

HARMONICS-PRODUCING EQUIPMENT (CURRENT DISTORTION)

- Personal computers
- Desktop printers
- Small battery chargers
- Electric-discharge lighting
- Electronic/electromagnetic ballasts
- Small electronic dimming systems

It should be noted that voltage distortion is more difficult to deal with because it is system-wide.

Harmonic Characteristics

- Harmonics are integer multiples of the fundamental frequency.
- First order is the fundamental frequency (e.g., 60 Hz); the second order is $2 \times 60 = 120$ Hz; the third order is $3 \times 60 = 180$ Hz; and so on.
- In three-phase systems, even harmonics cancel; odd harmonics are additive in the neutral and ground paths.
- Harmonics that are multiples of three are called triplens (i.e., 3rd, 9th, 15th, and so forth).
- Triplen harmonics, particularly the third, cause major problems in electrical distribution systems.

Problems with Harmonics

- Harmonics do no work, but contribute to the rms current that the system must carry.
- Triplen harmonics are additive in the system neutral.
- These currents return to the transformer source over the neutral and are dissipated as heat in the transformer, cables, and load devices.

Symptoms of Harmonic Problems

- Overheated neutral conductors, panels, and transformers
- Premature failure of transformers, generators, and UPS systems
- Lost computer data
- Interference on communication lines
- Operation of protective devices without overload or short circuit
- Random component failure in electronic devices
- Operating problems with electronic devices not traceable to component problems
- Interaction between multiple VFDs throwing off set points
- Interaction between UPSs and their supplying generators
- System power factor reduction and related system capacity loss
- Problems with capacitor operation and life

Harmonic Mitigation

Currently there are no devices that completely eliminate harmonics, and thus their effects; however, they can be mitigated substantially to control their deleterious consequences. Essentially, current techniques consist of accommodating harmonics, and include the following:

- Increasing neutral sizes, usually doubling feeder neutral sizes and installing a separate neutral with each single-phase branch circuit of a three-phase system, effectively a triple-neutral, rather than a single common neutral of the same size as the phase conductor.
- K-rated transformers.
- Harmonic-rated distribution equipment such as panelboards.
- Passive filters such as phase shifters, phase cancellers, zigzag transformers, and zero-sequence transformers.
- Active filters, electronic, primarily protects upstream equipment/devices.
- Proper grounding.
- Isolation transformers (electrostatically shielded).
- Motor-generator sets.
- Oversizing equipment.

Most of the above involve “beefing up” to accommodate harmonics.

ACTIVE VERSUS PASSIVE DEVICES

Active Devices

PROS

- Works well for mitigation of harmonics upstream of the device.
- Protects the transformer.

CONS

- Expensive.
- High maintenance costs.
- Uses power.
- Works only upstream.

Passive Devices

PROS

- No electronic circuitry.
- Very reliable.

CONS

- Work only upstream to accommodate harmonics.
- Location is critical.
- Phase loads must be balanced.
- Can be overloaded.
- Dissipate heat.
- Require fused disconnect.

Ultimate/Ideal Solution

The ultimate ideal solution would be:

- Eliminate the production of harmonics at the source (not just accommodate them).
- Be passive and therefore cost-effective, reliable, and efficient.
- Be easily installed and not require protection.
- Handle any load on the distribution system (not require load balancing to be effective).
- Resist overloading (not become a harmonic sink for the rest of the distribution system).

NOTES

A large grid area for taking notes, consisting of a 20x20 grid of small squares. The grid is empty and occupies the majority of the page below the 'NOTES' header.

Index

- Abbreviations, 28–29
- AC resistance and reactance, 182
- AC single-phase motors, overcurrent protection for, 256
- Activities, illumination levels for, 407–410
- Air-conditioning systems:
 - load demands, impact on, 178
 - load estimates for, 171, 173, 174
- Air flow, for generators, 386
- Air-handling units (AHUs), packaged rooftop, 503, 504
- Allowable Ampacity Tables 310–16 through 310–19, 95
- Aluminum bus ducts, weights of, 63
- Aluminum cable:
 - cross-linked polyethylene and ethylene rubber insulation, withstand chart for, 224
 - in magnetic conduit, voltage drop tables for, 280–284
 - in nonmagnetic conduit, voltage drop tables for, 285–289
 - with paper, rubber, or varnished cloth insulation, withstand chart for, 222
 - with thermoplastic insulation, withstand chart for, 223
 - voltage drop table for, DC, 279
- American National Standards Institute (ANSI), 451–453
- American Society of Heating, Refrigerating, and Air-Conditioning Engineers (ASHRAE), 172
- Americans with Disabilities Act (ADA):
 - fire alarm system requirements, 437, 445–450
 - mounting height guidelines, 30–32
- Americans with Disabilities Act Accessibility Guidelines (ADAAG), 445, 450
- Ampacity, conductor, 95–110
 - calculation for, 95, 110
 - of medium-voltage cable, 551–552, 556–557
 - selection of, 95
- Ampacity tables, 96–101
 - adjustment factors, 102, 108
 - conductor applications and insulation, 96–101, 111
 - for insulated conductors, 103–107
- Ampere ratings, standard, 82–84
- ANSI/EIA/TIA-568A, 452–453, 467, 469, 482
- Apartments, load estimates for, 173
- Appliances:
 - branch-circuit overcurrent protection for, 90
 - load estimates for, 171, 173
- Arcing, 325
- Attenuation, of horizontal cable, 453

- Automatic switching:
 - for elevators, 370–371
 - for hospitals and health care facilities, 372
 - for multiple-service generation, 363–370
- Automatic transfer switches, 340
 - for fire pumps, 500–502
- Autotransformers:
 - buck-boost types, 238–253
 - zig-zag grounding types, 238, 248, 249
- Auxiliary fire alarm systems, 438–439
- Backbone:
 - in blown optical fiber technology, 488
 - in structured cabling systems, 473–476, 478
- Backbone cabling:
 - between telecommunications rooms, 459
 - types, 452
- Backbone pathways, 473
 - interbuilding, 474, 479
 - intrabuilding, 474
- Ballasts, voltage variation effects on, 275
- Bandwidth, of optical fiber cable, 462, 467
- Batteries:
 - for generator starting, 386
 - for standby power, 360–361
- Bend radii, for horizontal pathways, 455, 478
- BloLite™, 488, 490–493
- Blown optical fiber technology (BOFT), 488–493
- Bonding conductors, ampacity ratings for, 109
- Branch circuit conductors:
 - ampacity and voltage drop, 95
 - overcurrent device location in, 84, 86
- Branch circuits:
 - coordination studies on, 208
 - oversizing for voltage drop, 303
- Buck-boost autotransformers, 238–253
 - applications of, 240
 - connection diagrams, 250–253
 - cost of, 251
 - life expectancy of, 251
 - load data, 241, 248, 250
 - operation and construction, 240–241
 - sound levels of, 251
 - three-phase, 250
- Buildings:
 - cabling systems within, 473
 - high-rise, water pressure–boosting power requirements, 175
 - lightning protection for, 332–333
 - pathways between, 474, 479
 - pathways within, 474
 - sound levels in, 255
 - special-use, equipment rooms in, 484
 - star topology wiring systems for, 458–459, 474
 - working space clearances in, 71
- Bus ducts, weights of, 63
- Bussman Low-Peak® time-delay fuse, 237
- Busways:
 - “C” values of, 191–193
 - low-voltage, *R*, *X*, and *Z* values for, 196
 - overcurrent protection for, 92
 - short-circuit rating standards, 226
 - voltage drop calculations for, 306–310
- Busway taps, overcurrent protection for, 92
- Bypass/isolation switch, 340

- Cable:
 - medium-voltage, 551–563
 - mineral-insulated, 495–500
 - termination hardware for, 465
 - twisted-pair, 454, 459, 461, 462, 467, 469
 - (See also Fiber-optic cabling; Horizontal cabling; Structured cabling systems)
- Cable trays, 458
- Canadian Standards Association (CSA), 451
- Candela, 403
- Candlepower, 403
- Category system:
 - for cable system components, 452–453, 465
 - for twisted-pair cabling, 461, 467
- Caterpillar Generator Sets, 373
- Ceilings, reflectance values, 426–427
- Central-station fire alarm system, 439
- Chart method of short-circuit calculation, 193, 197–204
- Checklists, for electrical designer, 1–18
- Circuit breakers:
 - adjustable-trip, 84
 - for automatic switching, 363–365
 - coordination studies, 207
 - current-limiting, 218
 - fixed thermal-magnetic trip, 214, 216
 - for ground fault protection, 330–331
 - molded-case, 228–232
 - for motor feeder protection, 256
- Circuit impedance, coordinating with short-circuit protection, 217
- Circuits:
 - for fire alarm systems, 440–445
 - Circuits (*Cont.*):
 - overcurrent protection location, 84–92
 - Classified locations, mineral-insulated cable for, 498, 500
 - Class 1, Class 2, and Class 3 circuits, conductor size minimums, 94
 - Clearances:
 - for electrical equipment in working spaces, 70–83
 - of medium-voltage cable, 558, 562
 - Code Letter E induction motors, overcurrent protection for, 256
 - Coefficient of grounding, 319
 - Coefficient of utilization, 412–417
 - Color:
 - and light, 423–436
 - lighting fixture effect on, 435, 436
 - Color coding, for telecommunications wiring, 464, 466, 479
 - Color rendition, 434, 436
 - Color temperature, 423
 - Comité Européen de Normalisation Electrotechnique (CENELEC), 451–453
 - Commercial buildings:
 - radial circuit arrangements in, 160
 - (See also Buildings)
 - Commercial power, 340
 - Computer programs:
 - for coordination studies, 204
 - for generator sizing in specific applications, 373
 - for three-phase short-circuit calculations, 185
 - Computer sites, UPS for, 400–401
 - Condensers, overcurrent protection for, 257–258

- Conductors:
 - ampacities, 95–110
 - applications of, 94–95
 - bare, 108, 113
 - compact, fill requirements, 125
 - construction, 94–95
 - coordination studies, 207
 - “C” values of, 191–193
 - for fire alarm circuits, 442–445
 - for general wiring, 92–110
 - insulated, 93–101, 108, 219–224
 - minimum size of, 93–94
 - overcurrent protection for, 93, 102
 - in parallel, 92–93
 - properties of, 93
 - short-circuit protection for, 208
 - 600-volt, 194–196
 - stranded, 92
 - temperature limitations on, 103–107
 - withstand ratings, 225
- Conduit:
 - bends in, 455
 - dimensions and percent area, table, 113–117
 - empty and filled, weight comparisons, 64
 - sizing, for structured cabling systems, 454
- Conduit fill information, 113, 125–157
 - for structured cabling systems, 478
- Conduit nipples, 102, 113
- Conduit pathways, 486
- Connectors:
 - in blown optical fiber technology, 488
 - for structured cabling systems, 463–465, 470–472
- Contact symbols, 510
- Control circuits:
 - conductor size minimums, 94
 - elementary diagrams of, 513–523
 - overcurrent protection for, 524–526
 - (*See also* Motor controllers)
- Coordination, selective, of overcurrent protection devices, 204–216
- Copper bus ducts, weights of, 63
- Copper cable:
 - with cross-linked polyethylene and ethylene propylene rubber insulation, withstand chart for, 221
 - horizontal cabling with, 467, 468
 - in magnetic conduit, voltage drop tables for, 291–295
 - in nonmagnetic conduit, voltage drop tables for, 296–300
 - with paper, rubber, or varnished cloth insulation, withstand chart, 219
 - short-circuit currents, allowable, 555
 - with thermoplastic insulation, withstand chart for, 220
 - for voice, 475
 - voltage drop table for, 290
- Cosine law of illumination, 405–407
- Cranes, conductor size minimums, 94
- Critical load, 386
 - overcurrent protection for, 399
- Cross-connect blocks, 480
- Cross-connect fields, 479, 480
- Cross-connect jumpers, 460, 480
- Current:
 - asymmetrical, 182–185
 - let-thru, 236
 - momentary, 184
 - short-circuit, 217–218
 - unequal division of, 93
- Current limitation, 218, 226–227
 - by fuses, 227, 234–238
- Current transformers (CTs), burdens on, 324
- Current wave distortion, 564

- Data processing equipment, load estimates for, 171
- DC circuits:
 - medium-voltage cable for, 552, 558
 - motors on, overcurrent protection for, 257
 - thermoplastic insulation use in wet locations, 94–95
- Demand, maximum, 177
- Demand factors, application of, 172, 176
- Derating, 102
- Design coordination checklist, 13–15
- Design process, information exchange during, 170
- Diagram symbols, 507–509
- Distributed secondary network, 168
- Distribution systems:
 - component sizing, 177
 - voltage tolerance limits, 269–273
- Drawing design checklist, 5–7
- Dual-source systems, grounding, 329
- Duplex connectors, 470–472
- Dwelling units, service
 - conductors and feeders for, 109–110
- Egress, illumination for, 341–342
- Electrical design professional,
 - coordination and information exchange with others, 170
- Electrical devices, mounting heights for, 30–32
- Electrical ducts, conductor ampacities for, 96–101
- Electrical inspectors, authority of, 69
- Electrical metallic tubing, 113
- Electrical nonmetallic tubing, 114
- Electrical symbols, 19–29
- Electrical systems:
 - emergency and standby, 339–401
 - low-voltage, 184
 - medium-voltage, 184
 - overcurrent protection device coordination within, 182, 204–216
 - short-circuit protection for, 217–238
 - voltage classes of, 268
- Electric signs, conductor size minimums for, 94
- Electroendosmosis, 95
- Electronic Industries Association (EIA), 451–453
- Elementary diagrams, 512
 - of control circuits, 513–523
 - symbols for, 507–509
- Elevator recall systems, 550–551
- Elevators:
 - conductor size minimums, 94
 - emergency power supply for, 342, 370–371
 - motor overcurrent protection for, 257
- Emergency lighting, 340–342
- Emergency power systems,
 - 339–401
 - definition of, 340
 - for elevators, 370–371
 - for fire alarm systems, 445
 - for fire pumps, 500
 - general need criteria for, 349–359
 - for hospitals and health care facilities, 372
 - for lighting, 340–342, 360
 - local generation, 361–362
 - for power loads, 342
 - power sources, 349
 - service connections, multiple, 362–365
 - state codes and regulations on, 342–348

- Enclosures:
 - for indoor and outdoor nonhazardous locations, 59
 - for indoor hazardous locations, 60
 - working space requirements, 81
- Energy Efficient Design of New Buildings Except New Low-Rise Residential Buildings, 172
- Entrance facilities (EFs), in telecommunications systems, 473, 483–486
- Entrances, to working spaces, 75–78
- Equipment:
 - computer and data-processing, grounding, 314
 - distribution, harmonic-rated, 566
 - harmonic-producing, 564
 - lightning protection for, 335–336
 - load estimates for, 171
 - over 600 volts, nominal, working space requirements, 80–83
 - sizes and weights, 62–64
 - withstand ratings of, 236
 - working space around, 70–78
- Equipment, utilization:
 - low-voltage-class voltages for, 265
 - voltage ratings for, 273–274
 - voltage tolerance limits, 269–272
 - voltage variation, effect on, 274–278
- Equipment cables, 454
- Equipment cords, for telecommunications cabling systems, 466, 472
- Equipment doors, 71, 74
- Equipment grounding, 313–314
- Equipment-grounding conductor, 314, 315
 - in parallel, 92
- Equipment rooms, in telecommunications systems, 462, 473, 475, 483, 484
- Exhaust from generators, 386
- Existing condition service and distribution checklist, 10–12
- Existing systems, coordination studies on, 208
- Exit lights, 340–342
- Fault conditions, bolted three-phase, 182
- Federal Communications Commission (FCC), 451
- Feeder conductors, overcurrent protection device location in, 84–85
- Feeders:
 - conductor ampacity and voltage drop, 95
 - for fire pumps, 496, 499
 - ground fault protection on, 329
 - oversizing for voltage drop, 303
 - medium-voltage cable for, 499
 - sizes, 311–312
- Feeder taps:
 - overcurrent protection exceptions for, 84–89
 - rules for, 84–92
- Fiber-optic cabling, 452
 - for backbone cabling, 473, 475, 476
 - bandwidths, 462, 467
 - connection hardware, 470
 - construction of, 472
 - system topology, 459, 474
 - termination hardware, 475
 - TIA-568A-recognized connectors, 463, 464
- Filters, passive and active, 566
- Fire, electrical symbols for, 24
- Fire alarm circuits, conductor size minimums for, 94
- Fire alarm system checklist, 16–18

- Fire alarm systems, 437–450
 - application tips, 450
 - basic elements of, 439–440
 - circuit designations, 440–441
 - Class A circuit installation, 441–445
 - classifications of, 438–439
 - code requirements, 438, 450
 - and elevator recall systems, 564–565
 - initiating device circuit performance, 442
 - notification appliance requirements, 443, 445–448
 - secondary supply capacity and sources, 445
 - signaling line circuits performance, 445
 - styles of, 441
- Fire protection, load estimates for, 171
- Fire pump controllers, 501, 502
- Fire pumps, 500–502
 - emergency power supply for, 342, 501
 - mineral-insulated cable for, 496
 - power requirements for, 176
 - step-loading, 501
- Fixture wires, dimensions of, 94, 112
- Flexible cords, 94, 102
- Flexible metallic conduit, 114, 115
- Flexible nonmetallic conduit, 115
- Flicker problems, 303–310
- Floors, reflectance values of, 426–429
- Floor systems, cabling, 479, 484, 485
- Fluorescent fixtures:
 - operation data, 435
 - voltage variation effect on, 275
- Food preparation equipment, load estimates for, 171
- Footcandle, 403
- Footlambert, 403
- Formulas and terms, 61
 - 480Y/277 V, for secondary voltage distribution, 181
- Frequency converters, for UPS, 400
- Fuel, for generators, 361, 386
- Fuses:
 - ampere ratings, 82
 - coordination studies on, 207
 - current-limiting, 218, 227, 234–238
 - for motor feeder protection, 256
 - time-current characteristic curve plotting, 214, 215
- General Cable Corporation, 488
 - Generation of power:
 - local, 361–362, 400
 - parallel, 366–370
 - (*See also* Generators)
- Generators:
 - airflow around, 386
 - continuous output, 382
 - diesel-electronic data ratings, 373–381
 - droop characteristics of, 362
 - effective SKVA of, 375, 381–383
 - for emergency lighting, 341
 - engine selection, 375–380
 - engine sizing, 375
 - exhaust from, 386
 - fuel for, 361, 386
 - gas-electric data ratings, 374–381
 - gas turbine-driven, 361
 - generator set sizing, 381
 - impedance in, 183
 - installation considerations, 381–383, 386
 - load factors of, 374
 - loads on, 375
 - mounting of, 386
 - peak shaving/sharing output, 382
 - prime output, 382
 - reactance grounding of, 324
 - selection of, 362
 - silicon-controlled rectifiers for, 386
 - sizing, 373–381, 384–385
 - standby output, 382–383
 - starting, 386
 - weights of, 63

- Generator terminals, overcurrent protection for, 92
- Grounded conductors, and equipment grounding, 314
- Grounded neutral conductors, in parallel, 93
- Ground fault currents, return path for, 313
(*See also* Grounding)
- Ground fault protection, 325–331
 - sensing faults, 326–330
- Ground fault relays (GFRs), 328, 330–331
- Ground faults, 325
 - arcing types, 325
 - sensing of, 326–330
- Grounding, 313–325
 - equipment grounding, 313–314
 - grounding-electrode systems, 318–319
 - and harmonics, 566
 - lightning protection, 331–338
 - of low-voltage systems, 314–317
 - of medium-voltage systems, 319–325
 - of telecommunications cabling systems, 473, 486
- Grounding conductors, ampacity ratings for, 109
- Grounding-electrode systems, 318–319
- Ground return sensing method, 326–327
- Ground straps, 326
- Harmonic effects, 564–567
 - mitigation of, 565–567
- Hazardous locations:
 - knockout dimensions for, 60
 - mineral-insulated cable for, 496, 497
 - standard enclosures for, 60
- Headroom requirements, for working spaces, 76–77
- Health care facilities:
 - emergency power systems for, 372
 - ground fault protection for, 326
 - load estimates for, 179–181
- Heating devices, voltage variation effects on, 278
- Heating systems, load needs, 171, 178
- Heat loss values, 175
- Hermetic motors, overcurrent protection for, 257
- High-voltage systems, 265
- Hoists, conductor size minimums for, 94
- Horizontal cabling:
 - configuration of, 458–459
 - copper, 467, 468
 - lengths of, 460
 - types of, 452, 454
- Hospitals:
 - emergency power systems for, 372
 - symbols for, 23
- Household fire alarm systems, 438
- HVAC systems, electrical systems for, 178–180
- IEEE power system device numbers, 35–57
- Illuminance, 403
- Illuminating Engineering Society of North America (IESNA), 172, 407
- Illumination, 403–436
 - conversion factors of, 405
 - cosine law, 405–407
 - illuminance level, selecting, 407–410
 - inverse square law, 405
 - and light source, transmittance, and reflectance, relationship of, 404
 - for working spaces, 75–76
 - zonal cavity method of calculating, 410–423

- Impedance, and voltage drop calculations, 303
- Incandescent lamps:
 - flicker from voltage dips, 306–308
 - voltage variation effects on, 275, 277
- Inductive reactance, minimizing differences in, 93
- Industrial applications, 90
- Initiating devices, for fire alarm systems, 439–443, 445
- Institute of Electrical and Electronics Engineers (IEEE), 80, 451
- Instrumentation circuits, conductor size minimums for, 94
- Insulated Cable Engineers Association (ICEA), 451
- Insulation:
 - failure of, 325
 - green, 314
 - thermoplastic, 94–95
- Interbuilding cabling, 474, 479
- Intermediate metallic conduit, 114
- International Electrotechnical Commission, 451–453
- International Organization for Standardization (ISO), 451–453
- Intrabuilding cabling, 474
- Inverse square law, 405
- Inverter systems, centralized, 360

- Jamming, 558–561
- Jockey pumps, 500

- Kitchens, commercial, power requirements in, 176, 179
- Knockout dimensions, 60

- Laboratories, emergency and standby power systems for, 342
- Lamps (*see* Lighting fixtures)
- Let-thru current:
 - of current-limiting fuses, 227, 234–238
 - determining, 236–238

- Life safety, and fire protection, 437
- Light, and color, 423–436
- Lighting, 403–436
 - branch circuit overcurrent protection for, 90
 - exit and emergency, 340–342
 - illumination, conversion factors, 405
 - light source illumination, transmittance, and reflectance, 404
 - load estimates for, 171
 - unit lighting power allowance, 172
- Lighting fixtures:
 - characteristics of, 423, 432–435
 - coefficient of utilization of, 412–417
 - and color, 435, 436
 - maintenance of, 419
 - number required, 421–423
 - selection of, 432–433
 - voltage variation effects on, 275, 277
- Lighting symbols, 19
- Lighting systems, voltage dip sensitivity, 303–307
- Light loss factor (LLF), 412, 418, 420
- Lightning, 331–332
- Lightning conductors, 332–333
- Lightning protection, 331–338
- Liquidtight flexible metallic conduit, 115
- Live parts:
 - guarding and elevating, 81–82
 - working clearances around, 70, 83
- Load:
 - continuity of, 386 (*see also* Uninterruptible power supply systems)
 - critical, 386
 - preliminary calculations, 170–181
- Load dumping, 368

- Load estimates, 171–181
 - comparison of, 177
 - and heating, ventilating, and air-conditioning system components, 178
- Load shed, for fire pumps, 500
- Local generation of power, 361–362
- Locked-rotor motors, 258
- Locking plugs and receptacles, 34
- Looped primary circuit arrangement, 167
- Low-voltage systems, 268
 - grounding, 314–317
- Lumen, 403
- Luminaire dirt depreciation (LDD), 418–420
- Luminance, 403
- Luminance ratios, recommended, 434
- Luminous intensity, 403
- Lux, 403
- Main-tie-main configurations, 365
- Medium-voltage cable, 551–563
 - ampacities of, 551–552, 556–570
 - bending radii, 561, 563
 - clearance for, 558, 562
 - DC field acceptance testing, 552, 558
 - dimensions of, 560–561
 - feeder sizing with, 499
 - in-air installations, 554
 - installation practices, 558
 - jacket materials, 559
 - jam ratios for, 558–561
 - short-circuit currents, allowable, 552, 555
 - underground installations, 553, 554
 - voltage drop in, 499
- Medium-voltage systems, 268
 - grounding, 319–325
- Mercury lamps, voltage variation effects on, 275
- Metal-halide lamps, voltage variation effects on, 278
- Microduct, in blown optical fiber technology, 488–493
- Microprocessors, equipment grounding systems for, 314
- Mineral-insulated (MI) cable, 495–500
 - for fire pumps, 496
 - for hazardous locations, 498, 500
 - size and ampacities of, 497
- Momentary current, 184
- Motor circuit data sheets, 259–264
- Motor circuit taps, overcurrent protection for, 92
- Motor control centers, working space clearances for, 71
- Motor controllers:
 - control and power connections, 510
 - diagrams of, 507–549
 - elementary diagrams of, 512–523
 - medium-voltage, 535–539
 - reduced-voltage, 540–549
 - short-circuit test ratings, 227
 - (*See also* Control circuits)
- Motor feeders, overcurrent protection for, 256–258
- Motors:
 - AC, code letters on, 381
 - conductor size minimums, 94
 - coordination studies on, 207
 - fault current, contribution to, 184–185
 - impedance in, 183
 - locked-rotor kilovolt-amperes, 310
 - nameplate voltage ratings, 274, 275
 - squirrel cage induction, 381, 383
 - and UPS, 399–400
 - voltage tolerance limits, 272, 273
 - voltage variation effect on, 275
- Motor starters, 259–265
 - wye-delta, 502, 503–506
- Mounting heights, 30–32
- Multiducts, in blown optical fiber technology, 488, 491, 492

- Multimode fiber, 452, 476
- Multiplexers (MUX), 477, 479
- Multi-User Telecommunications Outlet Assembly (MUTOA), 468
- Municipal fire alarm systems, 439
- National Electrical Code (NEC), 69, 438
 - Appendix C, 125–157
 - grounding requirements of, 313
- National Electrical Safety Code*, 80
 - grounding requirements of, 313
- National Fire Alarm Code, 445–450
- National Fire Protection Association, 69, 451
- National Research Council of Canada, Institute for Research in Construction (NRC-IRC), 451
- NEMA device configurations, 33–34
- Network demarcation point, 479
- Neutrals, 238, 248
 - ampacity ratings for, 108–109
 - grounding of, 314, 316
 - size of, and harmonic effects, 566
- NFPA-70, 69, 438
- Nonhazardous locations, standard enclosures for, 59
- Nonlinear loads, harmonic effects from, 564–567
- Nonlocking plugs and receptacles, configuration chart for, 33
- Nonredundant UPS configuration, 387
- Notification appliances, for fire alarm systems, 439–441
 - audible, 445–447
 - circuits of, 443, 445
 - visual, 445, 448
- Ohmic method, for three-phase short-circuit calculations, 185
- Ohm's law, 182–183
- One-line diagrams, 204–209
 - symbols for, 26–27
- 120/240-volt, three-wire, single-phase conductors, 109
- Optical fiber cabling, 462, 470, 472, 475, 480
 - (*See also* Blown optical fiber technology; Fiber-optic cabling)
- Outside conductors, 88
- Overcurrent protection:
 - ampere ratings, standard, 82–84
 - for control circuits, 524–526
 - for motor feeders, 256–258
 - for transformer primaries and secondaries, 243
- Overcurrent protective devices:
 - coordination of, 204–216
 - current-limiting, 218
 - for fire pumps, 500
 - IEEE standard numbers for, 35–57
 - let-thru energy, 218
 - location in circuit, 82–92
 - maximum rating or setting for, 232
 - short-circuit protection from, 182
- Packaged rooftop air-handling units (AHUs) with remote mounted variable-frequency drives (VFDs), 503, 504
- Parallel, conductors in, 92–93
- Parallel generation, 366–370
- Patch cables and jumpers, 460, 464
- Patch cords, 466, 472
- Pathways:
 - backbone, 473
 - entrance facility, 473
 - horizontal, 458–459
 - separation of telecommunications, 486
- Per-unit method, for three-phase short-circuit calculations, 185
- Plugs, locking and nonlocking, 33–34
- Plumbing and sanitation, load estimates for, 171

- Point sources, 405
- Point-to-point method, for three-phase short-circuit calculations, 185–190
- Polyphase motors, overcurrent protection for, 256
- Power, electrical symbols for, 21
- Power lines, separated from telecommunications pathways, 486
- Power sources, dual, 397–399
- Primary circuit arrangement, looped, 167
- Primary radial-selective arrangements, 163
- Primary-selective circuit arrangement, 166
- Prime mover supply choices, 361
- Project to do checklist, 2–4
- Proprietary supervising station fire alarm systems, 439
- Protected-premises fire alarm systems, 438–440
- Pull boxes, 455–457
- Pulling tensions, 561
- PVC conduit, rigid, 116, 117
- PVC conduit, type EB, 117

- Raceway fill information, 92–157
 - NEC Appendix C, 125–157
 - tables, 96–124
- Raceways:
 - derating factors for, 102
 - jamming of, 112
 - as telecommunications cable pathways, 473
- Radial circuit arrangements:
 - in commercial buildings, 160
 - common primary feeders, 161
 - individual primary feeders, 162
- Reactance, for short-circuit calculations, 182–185
- Reactance grounding, 324
- Receptacles:
 - load estimates for, 173
 - locking and nonlocking, 33–34
- Redundancy, 370
- Reflectance, and light source, illumination, and transmittance, 404
- Reflectance values, 421, 426–429, 434
- Refrigeration, load demands of, 178
- Regenerated power, in elevators, 370–371
- Relays:
 - coordination studies on, 207
 - fault currents at, 324, 325
 - for multiple-service systems, 363–365
 - time-current characteristic curve plotting, 214, 215
- Remote annunciation, for fire pump controllers, 501
- Remote supervising-station fire alarm systems, 439
- Residual sensing method, 328–329
- Resistance-grounded systems, 317
- Resistors, selective fault isolation with, 324
- Rigid metallic conduit, 116
- Rigid PVC conduit, 116, 117
- Rooms:
 - cavity ratios, 424–425
 - luminaires required for, 421–423
 - surface dirt, 419–420
- Root mean square (rms), 218

- Secondary network arrangement, distributed, 168
- Secondary-selective circuit arrangements, 164–166
- Secondary voltage selection, 181
- Security, electrical symbols for, 25
- Seismic code requirements, 62, 65–66
- Selective coordination studies, 204–216
 - example, 209–214
 - short-cut ratio method, 214–216
- Selectivity ratio guide, 216
- Service connections, multiple, 362–365

- Service continuity, and ground fault protection, 330
- Service disconnects, ground fault protection for, 325–326
- Service-entrance equipment:
 - for health care facilities, 179–181
 - overcurrent protection for, 91
- Service mains, system power loss considerations, 170
- Short-circuit calculations, 182–204
 - adding Zs methods, 186
 - asymmetrical components, 182–185
 - bolted three-phase fault conditions, 182
 - short-cut methods, 186, 193
 - for three-phase systems, 185–186
- Short-circuit closing angle, 227
- Short-circuit currents, allowable, 552
- Short-circuit power factor, 227
- Short-circuit protection, withstand ratings, 217–238
- Short-circuit test currents, 234
- Signaling circuits:
 - conductor size minimums, 94
 - for fire alarm systems, 439–445
- Silicon-controlled rectifiers (SCRs), 381, 386
- Simplex connectors, 471
- Singlemode fiber, 452, 476
- Single-phase systems:
 - buck-boost transformer auto-transformer arrangement, 250, 251
 - voltage nomenclature, 272
- Site design checklists, 8–9
- Sleeves, in telecommunications rooms, 473, 477
- Slots, in telecommunications rooms, 473, 477
- Smoke detectors, 550
- Sodium lamps, 278
- Sound characteristics, of transformers, 251, 254–256
- Space conditioning, load estimates for, 171
- Spot network, basic, 169
- Square D Company, 265, 266–267, 506
- Squirrel cage induction motors:
 - running load on, 381, 383
 - starter characteristics, 259–265
- Standby power systems, 339–401
 - batteries for, 360–361
 - definition of, 340
 - general need criteria, 349–359
 - for lighting, 340–342, 360
 - local generation, 361–362
 - for power loads, 342
 - power sources, 349
 - service connections, multiple, 362–365
- Starters:
 - manual, 527–534
 - reduced-voltage, 502
- Star topology:
 - for backbone wiring, 474
 - for horizontal cabling, 458–459
- States, emergency power codes and regulations, 342–348
- Steady-state condition, 182–184
- Storage batteries, 341
- Stranded conductors, 92
- Structured cabling systems, 450–487
 - backbone system for, 473–476, 478
 - connectors, 463–465, 470, 471
 - elements of, 451
 - entrance facilities (EFs), 483–485
 - equipment rooms (ERs), 483, 484
 - floor sleeves and slots, 497
 - industry standards, 452–453
 - optical fibers in, 472
 - patch cords, 466, 472
 - power line separation, 486
 - specifications, 454–458
 - telecommunications room (TR), 479–482
 - topology, 458–459
 - twisted-pair, 461, 462, 467, 469
 - (*See also* Horizontal cabling)

- Structures, lightning protection for, 332–333
- Substations, outdoor, grounding-electrode systems for, 318
- Subtransient reactance, 183
- Supply-side equipment, safety requirements for, 80
- Switchboards, working space clearances for, 75, 81
- Switches:
 - automatic transfer types, 340
 - bypass/isolation types, 340
 - electrical symbols for, 20
 - fusible, for ground fault protection, 331
 - manual motor starting, 527–534
 - withstand test requirements, 233
- Synchronous reactance, 184
- System configurations, 159–169
- System power losses, and service main sizing, 170

- Tables, on conduit fill and tubing, 96–157
- Tape drives, feeder sizing for, 258
- Tasks, illumination levels for, 407–410
- Telecommunications cable (*see* Structured cabling systems)
- Telecommunications Industry Association/Electronic Industries Alliance (TIA/EIA), 451–453
- Telecommunications pathways, separation from power lines, 486
- Telecommunications room (TR):
 - in backbone system, 459, 473, 475
 - connections in, 458–459, 479
 - industry standards, 482
 - size/space requirements, 480
 - temperature requirements, 479
 - typical layout, 481
- Temperature compatibility, and allowable ampacities, 102
- Temperature limitations:
 - on cable, 479
 - on conductors, 103–107
 - for equipment rooms, 483
- Temperature ratings, of transformers, 254
- Termination hardware:
 - for category-rated cabling systems, 465
 - of fiber-optic cabling, 475
- Thermoplastic insulation, 94–95
- Three-phase systems:
 - buck-boost transformer auto-transformer arrangement, 253
 - grounding of, 316
 - voltage nomenclature, 272
- Thunderstorms, frequency of, 332–334
- Time-current curves:
 - for coordination studies, 204
 - examples of, 210–215
- Torque, of motor starters, 259
- Transfer devices, 363–369
- Transfer pair, 365
- Transfer switches, 397–399
- Transformers:
 - auto zig-zag grounding types, 238, 248, 249
 - buck-boost types, 238–253
 - connections of, 245–247, 268
 - coordination studies on, 207
 - electrical characteristics of, 238–253
 - full-load current, three-phase, self-cooled ratings, 239
 - isolation, 566
 - K-rated, 566
 - medium-voltage-class voltages for, 268
 - overcurrent protection for, 243
 - secondary short-circuit capacity of, 205–206
 - sound characteristics of, 254–256
 - thermal characteristics of, 254–255
 - three-phase, 240

- Transformers (*Cont.*):
 - transformer loss and impedance data, 240–242
 - voltage drop calculations for, 301–309
 - weights of, 63
- Transformer secondary conductors, 89–91
- Transient reactance, 183–184
- Transmission substations, 268
- Transmittance, and light source, illumination, and reflectance, relationship of, 404
- Transportation within buildings, load estimates for, 171
- Triplen harmonic currents, 93
- Tubing, dimensions and percent area, table, 113–117
- Twisted-pair cable, 454, 459, 461, 462, 467, 469, 475, 480
- 208Y/120–V, for secondary voltage distribution, 181

- Ufer ground, 318
- UL Master Label System, 338
- Ungrounded systems, 316
- Uninterruptible power supply (UPS) systems, 340, 341, 386–401
 - application of, 391
 - bypass provisions, 399
 - cold standby redundant configuration, 387–389
 - definition of, 386–387
 - distribution systems, 399–400
 - with dual utility sources and static transfer switches, 397–399
 - 400-Hz power distribution systems, 400–401
 - frequency converters, 400
 - hot-tied-bus systems, 394, 396
 - isolated redundant configuration, 390–391, 395
 - nonredundant configuration, 387, 388
- Uninterruptible power supply (UPS) systems (*Cont.*):
 - parallel configuration, 389–390, 392, 393
 - redundant systems, 392–395, 397
 - single-module system, 391
 - 60-Hz power distribution systems, 391–399
 - superredundant parallel systems—hot-tied-bus system, 397
 - tandem systems, 394, 395
 - UPS module, 387
- United States:
 - emergency power system regulations, 342–348
 - seismic zone map, 65
 - thunderstorm days map, 334
 - voltages in, standard, nominal, 265–268, 270–271
- Unit equipment, for emergency lighting, 342
- Unit lighting power allowance (ULPA), 172
- UPS (*see* Uninterruptible power supply systems)
- UPS module, 387
- Utilities, rate structures and classes of, 170
- Utilization equipment (*see* Equipment, utilization)

- Variable-frequency drives (VFDs), remote mounted, 503, 504
- Variable-speed motor controls, 381
- Vectorial summation methods, for sensing ground faults, 329
- Ventilating systems, load demand, 178
- Voltage:
 - applied, and let-thru performance of fuses, 227
 - in foreign countries, 269
 - reference, for coordination studies, 208
 - standard, 265–278

- Voltage (*Cont.*):
 - system tolerance limits, 269–273
 - system voltage classes, 265, 268
 - U.S. standard, 265–268, 270–271
 - variations in, 274–278
- Voltage dip, 303–310
 - of generators, 375
- Voltage drop, 278–309
 - ANSI/NFPA 70–1996 and NEC recommendations on, 170, 303
 - and battery capacity, 361
 - calculations of, 278–309
 - for fire pump wiring, 500
 - of medium-voltage cable, 499
 - tables of, 279–300, 302, 304–305
- Voltage ratings, for utilization equipment, 274
- Voltage selection, secondary, 181
- Voltage wave distortion, 564

- Water-heating systems, power requirements for, 175
- Water pipes, as grounding electrodes, 318, 319
- Water pressure–boosting systems, power requirements for, 175
- Wet locations, thermoplastic insulation for, 95
- Wiring, conductors for, 92–110

- Wiring diagrams, 511
 - contact symbols, 510
 - for motor control, 507–549
 - symbols on, 25, 507–510
 - terminology, 511–512
- Wiring symbols, 25, 507–510
- Withstand ratings, 207, 217–238
- Work areas (WAs), in telecommunications cabling, 458–460, 462, 468
- Working space, 52–59
- Wound-rotor motors, overcurrent protection for, 256
- Wye-delta motor starters, 503, 505–506

- Zero-sequence sensing method, 326–328
- Zonal cavity method, for calculating illumination, 410–423
 - coefficient of utilization for, 412–417
 - light loss factor, 412, 418
 - luminaire dirt depreciation, 418–420
 - luminaires, number required, 421–423
 - room surface dirt, 419–420
- Zone interlocking, 330–331

ABOUT THE AUTHOR

Robert B. (Bob) Hickey, P.E., is a licensed professional engineer in five states and is president and chief executive officer of vanZelm, Heywood & Shadford, Inc., a leading northeast-U.S. mechanical and electrical consulting engineering firm based in West Hartford, Connecticut. His 40 years of experience spans the electric utility, contracting, and consulting engineering areas of the industry spectrum. He has taught electrical engineering technology as an adjunct faculty member over a 2-year period in Connecticut's community-technical college system. He also coauthored the electrical chapter of McGraw-Hill's *Field Inspection Handbook*, Second Edition, and authored McGraw-Hill's *Electrical Construction Databook*.

NOTES

A large grid area for taking notes, consisting of 20 columns and 30 rows of small squares. The grid is enclosed in a black border and occupies the majority of the page below the 'NOTES' header.

NOTES

A large grid area for taking notes, consisting of a 20x20 grid of small squares. The grid is empty and occupies the majority of the page below the 'NOTES' header.

NOTES

A large grid area for taking notes, consisting of a 20x20 grid of small squares. The grid is empty and occupies the majority of the page below the 'NOTES' header.